



TECH POWER
ELECTRONICS GROUP



 **MARSCHNER**

Transformatoren
Transformers

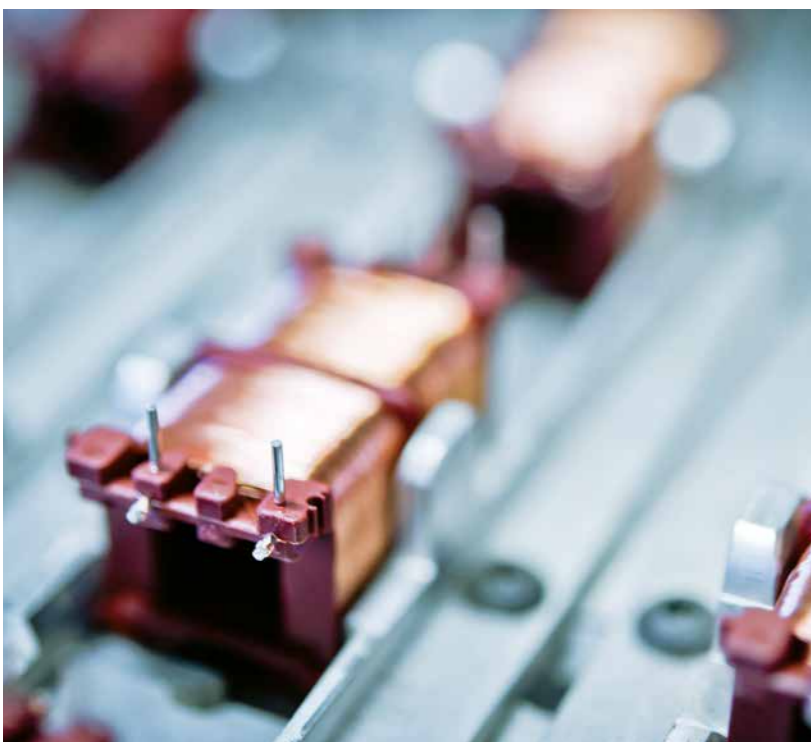
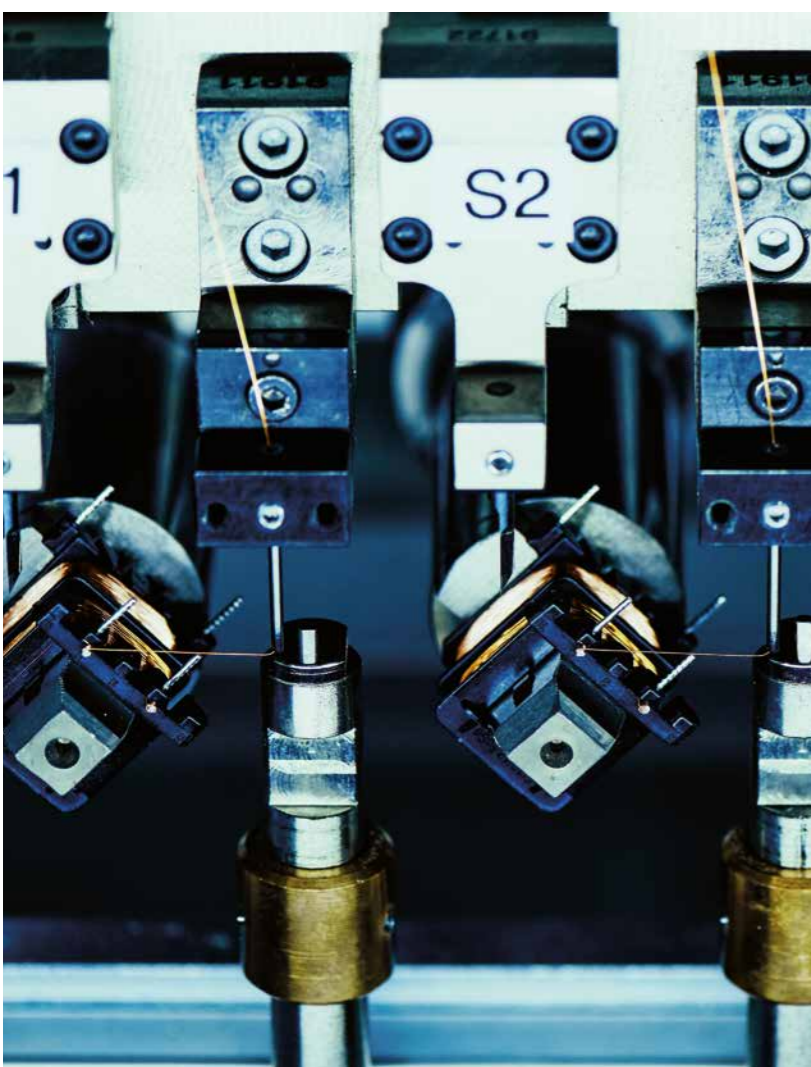

„Qualität beginnt damit,
„Quality begins by placing
die Zufriedenheit des Kunden
customer satisfaction
in das Zentrum des Denkens
in the center of our thinking.“
zu stellen.“

John F. Akers

Erfahrung ist unsere Stärke
Experience is our strength

Kundenzufriedenheit steht bei MARSCHNER in der Tat an erster Stelle. Seit der Unternehmensgründung im November 1969 durch Horst Marschner bürgt der Name MARSCHNER für exzellente und innovative Qualität, weit über die Grenzen von Deutschland hinaus. Die Ausdehnung des Produktprogramms erfolgte auf dynamische und zuverlässige Weise. MARSCHNER ist dadurch zum Spezialisten im Bereich der qualitativ hochwertigen Stromversorgung geworden.

The satisfaction of our customers has absolute priority for MARSCHNER. Since the company was established in November 1969 by Horst Marschner, the name MARSCHNER has guaranteed excellent and innovative quality far beyond Germany. The product range has been expanded in a dynamic and reliable manner. MARSCHNER has now become a specialist in the field of high-quality power supply.

Unsere Kunden schätzen insbesondere die Zuverlässigkeit unserer qualifizierten und motivierten Mitarbeiter. Geschäfte werden immer noch unter Menschen gemacht. Und dabei ist auf MARSCHNER stets Verlass. Unsere internationalen Kunden sind im Bereich der Sicherheits- und Medizintechnik, im Maschinenbau sowie in der Steuerungs- und Automatisierungstechnik tätig. Gerade hier kommt es ganz besonders auf Präzision und Zuverlässigkeit an. Rund um das umfangreiche Produktprogramm bietet MARSCHNER seinen Kunden ein großes Paket an Mehrwert und Serviceleistungen an. In partnerschaftlicher Zusammenarbeit mit unseren Kunden entwickeln wir kundenspezifische Transformatoren. Sonderausführungen sind z.B. unterschiedliche Temperaturklassen, verschiedene Gehäuseausführungen, spezifische Primär- und Sekundärspannungen oder auch eingegossene Thermosicherungen.

Our customers especially appreciate the reliability of our qualified and motivated employees. Eventoday, business is a matter between people – and in this relationship, you can always rely on MARSCHNER. We have international customers from various fields – safety and medical engineering, mechanical engineering as well as control and automation engineering – all these require utmost precision and reliability. MARSCHNER offers its customers a large scope of added value and excellent service as part of the wide range of products. In good business partnership with our customers, we develop customized transformers. Special versions are, for example, different temperature categories, various case versions, specific primary and secondary voltages or even cast-in thermal fuses.

Unser umfangreiches Produktprogramm:

- Print-Transformatoren
- Flach-Transformatoren
- Ringkern-Transformatoren
- Steuer-Transformatoren
- Netz-Transformatoren
- Gleichspannungs-Transformatoren
- Halogenlampen-Transformatoren
- Transformator-Module
- Netzdrosseln
- Zündübertrager
- Ferrit Bauteile
- Spulen

Our wide product range:

- Print transformers
- Low-profile transformers
- Toroidal transformers
- Control transformers
- Power transformers
- Direct voltage transformers
- Halogen lamp transformers
- Transformer modules
- Line chokes
- Spark transformers
- Ferrite components
- Coils

Auch bei der Verpackung ist MARSCHNER sehr flexibel und richtet sich nach den speziellen Wünschen der Kunden. Aufgrund der großen Fertigungstiefe können in diesem Katalog nur die Standardausführungen aufgeführt werden. Von diesen haben wir permanent über 100 unterschiedliche Ausführungen am Lager verfügbar. Innerhalb von 24h schicken wir diese auf die Reise.

Erfahren Sie mehr über die weite Welt der MARSCHNER-Produkte. Wir wünschen Ihnen viel Spaß beim Stöbern in unserem neuen Produktkatalog!

Even when it comes to the packaging of products, MARSCHNER is very flexible and always meets the special demands of its customers.

Our high vertical integration is the reason why we can only present the standard versions in this catalog. From this range of standard versions, we always have more than 100 different versions available on stock. Within 24 hours we can have them on their way to you.

Find out more about the wide world of MARSCHNER products. We wish you much pleasure in browsing our new product catalog!

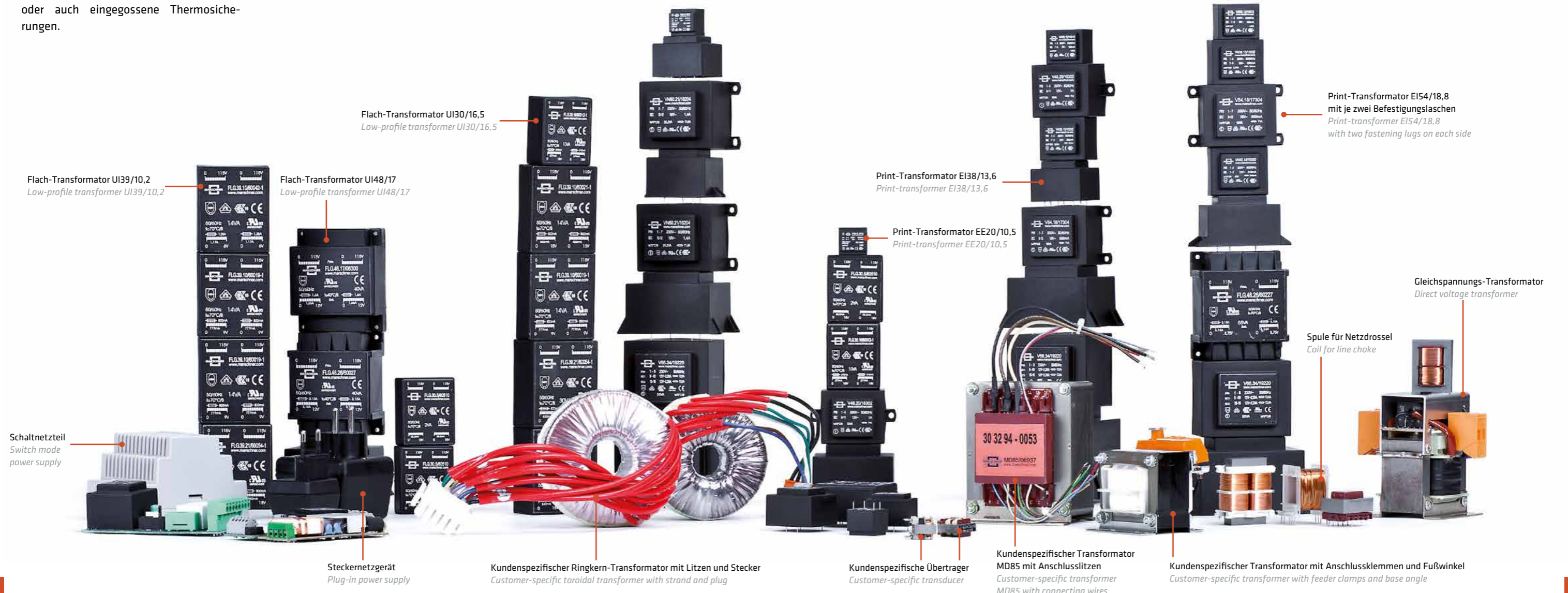

Flach-Transformator UI39/10,2
Low-profile transformer UI39/10,2

Flach-Transformator UI48/17
Low-profile transformer UI48/17

Flach-Transformator UI30/16,5
Low-profile transformer UI30/16,5

Schaltnetzteil
Switch mode power supply

Steckernetzgerät
Plug-in power supply

Kundenspezifischer Ringkern-Transformator mit Litzen und Stecker
Customer-specific toroidal transformer with strand and plug

Kundenspezifische Übertrager
Customer-specific transducer

Kundenspezifischer Transformator MD85 mit Anschlusslitzen
Customer-specific transformer MD85 with connecting wires

Kundenspezifischer Transformator mit Anschlussklemmen und Fußwinkel
Customer-specific transformer with feeder clamps and base angle

Print-Transformator EI38/13,6
Print-transformer EI38/13,6

Print-Transformator EE20/10,5
Print-transformer EE20/10,5

Print-Transformator EI54/18,8 mit je zwei Befestigungslaschen
Print-transformer EI54/18,8 with two fastening lugs on each side

Gleichspannungs-Transformator
Direct voltage transformer

Spule für Netzdrossel
Coil for line choke

10 gute Gründe, MARSCHNER zu wählen

10 good reasons to choose MARSCHNER

- 1** Mehr als 40 Jahre Erfahrung in der Entwicklung, Fertigung und Vermarktung von hochwertigen Transformatoren
The experience from more than 40 years of work in development, manufacturing and marketing of high-grade transformers
- 2** Klein- und Großserienproduktion möglich
Small and large series available
- 3** Sehr tiefes und breites Produktprogramm, umfangreiche Prüfzeichen für Standardprodukte vorhanden
Very deep and wide product range, a wide scale of approvals for standard products available
- 4** 100%ige Qualitätskontrolle
100% quality control
- 5** Zugriff auf 35 Ingenieure und Techniker der TECH POWER ELECTRONICS GROUP
Access to 35 engineers and technicians of the TECH POWER ELECTRONICS GROUP
- 6** Hohe Langlebigkeit der Produkte durch Vakuumverguss
High lifetime of products through vacuum casting
- 7** Spezialist für kundenspezifische Ausführungen
Specialist for customized versions
- 8** Schnelligkeit bzgl. Musterfertigung, Angebotserstellung und Vorserienproduktion
Fast response in the fields of sample products, preparation of quotations and pre-series production
- 9** Flexibilität bzgl. Musterfertigung, Kundenanforderungen und Produktionsmenge
Flexibility in sample manufacturing, customer requirements and production quantity
- 10** Fertigung im In- und Ausland → ausreichende Kapazitäten
Manufacturing in the country and abroad → sufficient capacities

MARSCHNER ist der zuverlässige
MARSCHNER is your reliable
und kompetente Partner für qualitativ
and competent partner for
hochwertige Stromversorgung!
high-quality power supply!

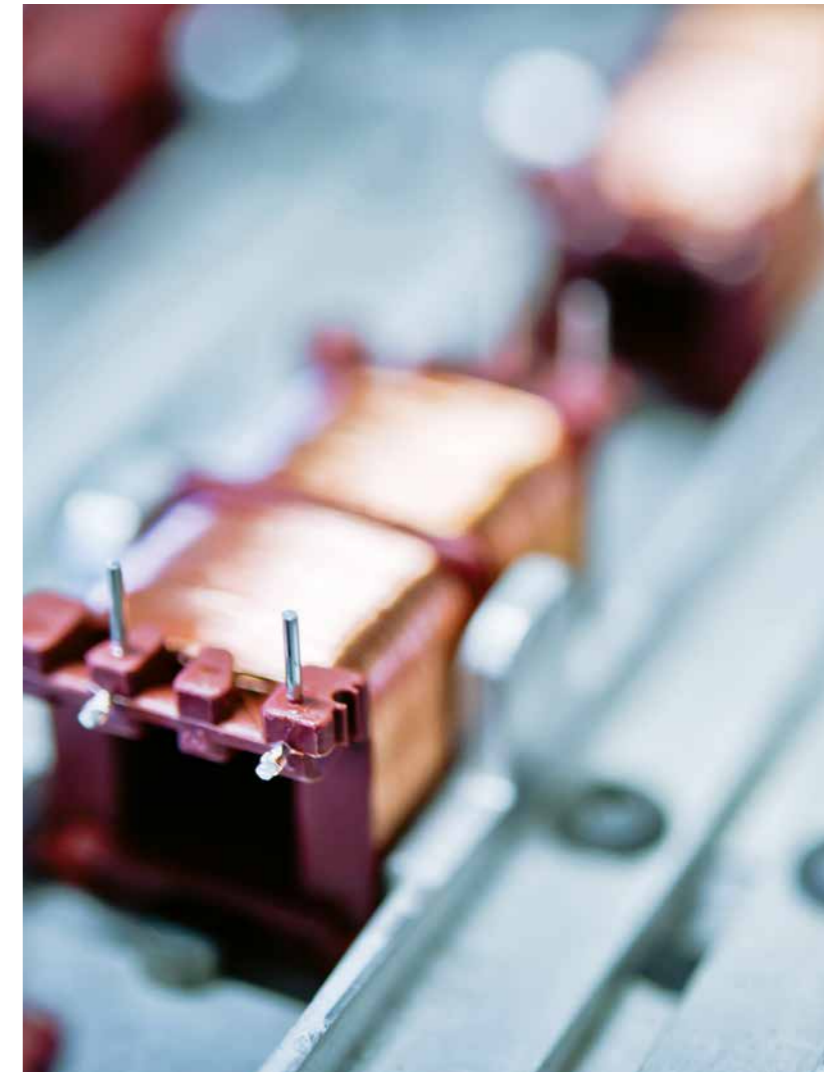
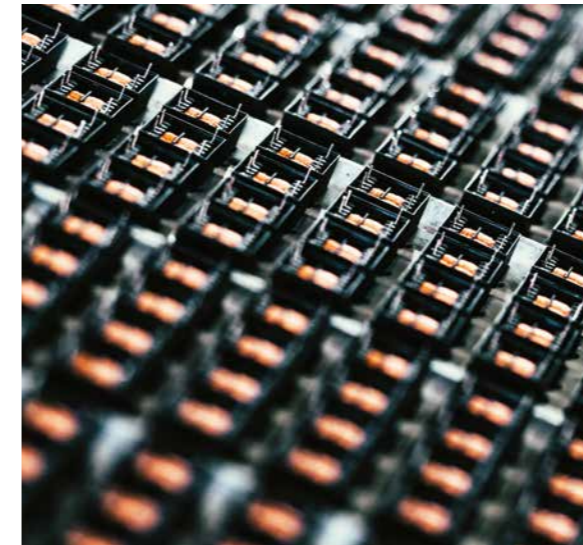

Wissenswertes über Transformatoren

What you should know about transformers

Grundsätzliches über Transformatoren

Transformatoren werden zur Umwandlung der zur Verfügung stehenden Spannung bzw. zur sicheren Trennung zwischen Eingang und Ausgang sowie zur Übertragung von Signalen verwendet. Hierzu werden sie hinsichtlich ihrer Verwendung unterschieden:

- Einphasen-Transformator
- Dreiphasen-Transformator (Drehstrom)
- Übertrager (Ton/NF und HF)
- Wandler
(Strom und Spannung im Bereich Messtechnik)
- Leistungsübertrager (getaktete Netzteile)
- Impulsübertrager (Ansteuerung elektronischer Bauelemente)
- Zündübertrager (Zündung von Gasgemischen in Gasthermen, Gasherden)
- Hochspannungstransformator

Die Einphasen-Netztransformatoren werden ebenfalls unterteilt und so unterscheidet man folgende Arten:

- Sicherheits-Transformator
- Trenn-Transformator
- Netz-Transformator
- Steuer-Transformator
- Klingel-Transformator
- Zünd-Transformator
- Spar-Transformator

An Transformatoren werden gemäß der Vorschrift VDE 0570 (EN 61558) Sicherheits- und Funktionsanforderungen gestellt. Einige Anforderungen sind bei den Zeichenerklärungen (ab Seite 173) aufgeführt.

Leistung von Transformatoren

Das Produkt aus Spannung und Strom ergibt die elektrische Leistung. Dies bedeutet bei einem idealen Transformator, dass die abgegebene Leistung gleich der aufgenommenen Leistung ist. Bei einem realen Transformator entstehen jedoch Verluste. Schon bei einem unbelasteten Transformator (Leerlauf) treten Verluste (im wesentlichen Eisenverluste) auf. Diese Eisenverluste entstehen durch das ständige Ummagnetisieren des Eisenkerns und die durch das zeitlich veränderliche Magnetfeld entstehenden Wirbelstromverluste. Durch die Wahl der Kernbleche können diese beeinflusst werden.

General information about transformers

Transformers are used for the conversion of the available voltage or for the safe separation between input and output as well as for the transfer of signals. In this context, they are distinguished according to their use:

- Single-phase transformer
- Three-phase transformer (three-phase alternating current)
- Transducers (sound/LF and HF)
- Converters (Current and voltage in the field of measurement engineering)
- Power transformer (synchronized power suppliers)
- Impulse transformer (activation of electronic components)
- Spark transformers (ignition of gas mixtures in gas furnaces and gas stoves)
- High-voltage transformer

Single-phase power transformers are also subdivided, and so the following types are distinguished:

- Safety isolating transformer
- Isolating transformer
- Power transformer
- Control transformer
- Bell transformer
- Spark transformer
- Auto transformer

Safety and functional requirements are made on transformers according to VDE 0570 (EN 61558). Some requirements are quoted in the legends to symbols (starting from page 173).

Power of transformers

The product of voltage and current is the electric power. With an ideal transformer, this means that the power output equals the power input. With a real transformer, however, there is a certain loss. Even a transformer at idle is subject to losses (mainly iron losses). These iron losses are caused by the permanent changes in magnetizing of the iron core and the eddy current losses caused by the time changes in the magnetic field. These losses can be influenced by the selection of core plates.

Leerlauf- und Lastspannung

Die Leerlaufspannung liegt über der Lastspannung. Hier unterscheidet man zwischen weichen und steifen Transformatoren. Das Verhältnis zwischen diesen Spannungen ist unter anderem abhängig von der Kurzschlussfestigkeit. Bei unbedingt kurzschlussfesten Transformatoren (weich), bei denen die Kurzschlussfestigkeit durch die Impedanzen der Wicklungen erreicht wird, kann der Unterschied zwischen Leerlauf- und Lastspannung bis zu 100% betragen. Bei nicht kurzschlussfesten Transformatoren (steif) ist dieser Unterschied wesentlich geringer. Die maximal zulässigen Unterschiede sind leistungsabhängig und in entsprechenden Teilen der VDE-Vorschrift 0570 (EN61558) vorgegeben.

Überlast und Kurzschluss

Beim Schutz gegen Überlast oder Kurzschluss wird unterschieden zwischen kurzschlussfest bzw. bedingt kurzschlussfest und nicht kurzschlussfest.

Kurzschlussfest:

Unbedingt kurzschlussfest: Kurzschlussfestigkeit wird durch Eigenimpedanzen der Wicklungen erreicht.
Bedingt kurzschlussfest: durch integrierte Schutzeinrichtung (Temperatursicherung, Temperaturschalter, PTC)

Nicht kurzschlussfest:

Nicht kurzschlussfeste Transformatoren müssen durch geeignete Schutzeinrichtungen (Sicherungen, PTC usw.) an der Primär- oder Sekundärseite abgesichert werden. In allen genannten Fällen ist der Schutz so zu wählen, dass die maximal zulässigen Temperaturen der entsprechenden Isolierstoffklasse bei Bemessungs-Umgebungstemperatur nicht überschritten werden.

Bemessungs-Umgebungstemperatur und Isolierstoffklasse

Auf den Transformatoren werden beide Werte in Form von z. B. ta 70°C/B angegeben.

- ta 70°C ist die max. Bemessungs-Umgebungstemperatur, bei welcher der Transformator eingesetzt werden kann
- /B beschreibt die verwendeten Isolierstoffe (der Wert des niedrigsten Werkstoffs im System), hier B = 130°C

Einsatz von Gleichrichterschaltungen

Bei Einsatz von Gleichrichterschaltungen an Transformatoren muss berücksichtigt werden, dass die Transformatorleistung nicht gleich der Gleichstromleistung ist. Entsprechend der verwendeten Gleichrichterschaltung ergeben sich Erhöhungen der Transformatorleistung.
Einweggleichrichtung: ca. Faktor 3
Mittelpunktschaltung: ca. Faktor 1,5
Brückengleichrichtung: ca. Faktor 1.25

No-load and load voltage

The no-load voltage is higher than the load voltage. In this context, a distinction is made between soft and rigid transformers. The ratio between these voltages depends, among other factors, on the short circuit resistance. With inherently short-circuit proof transformers (soft), with which the short-circuit resistance is achieved by the impedance of the windings, the difference between no-load voltage and load voltage may amount up to 100%. With not short-circuit proof transformers (rigid), this difference is much lower. The maximum permissible differences depend on power and are specified in the applicable parts of the VDE provision 0570 (EN 61558).

Overload and short-circuit

In respect to overload or short circuit, a distinction is made between short-circuit proof and conditionally short-circuit proof.

Short-circuit proof:

Inherently short-circuit proof: Short-circuit resistance is achieved by impedances of the windings.
Conditionally short-circuit proof: Through integrated protector (thermal fuse, thermal switch, PTC)

Non short-circuit proof:

Transformers must be secured by using appropriate protectors (fuses, PTC, etc.) on the primary or on the secondary side.
In all cases mentioned, an appropriate protector must be selected to avoid that the maximum permissible temperatures of the corresponding insulant category is not exceeded at design-ambient temperature.

Design ambient temperature and insulant category

On the transformers, both values are quoted in form of, for example, ta 70°C/B.

- ta 70°C is the maximum design ambient temperature at which the transformer can be applied
- /B describes the insulant used (the value of the lowest material in the system), here B = 130°C

Application of rectifier circuits

When rectifier circuits are used on transformers, it must be taken into consideration that the transformer power does not equal the direct current power. According to the rectifier circuit, increases in transformer power will occur.
One-way rectification: Approx. factor 3
Switching at neutral point: Approx. factor 1.5
Bridge rectification: Approx factor 1.25

Inhaltsverzeichnis

Index

Seite/Page	Produkt/Product	Leistung/ Power
03	Einleitung <i>Introduction</i>	
06	10 gute Gründe MARSCHNER zu wählen <i>10 good reasons to choose MARSCHNER</i>	
08	Wissenswertes über Transformatoren <i>What you should know about transformers</i>	
10	Inhaltsverzeichnis <i>Index</i>	
12	EE20-Transformatoren <i>EE20-transformers</i>	
13	EE20/6.1	0.35 VA
14	EE20/10.5	0.50 VA
15	EI30-Transformatoren <i>EI30-transformers</i>	
16	EI30/5	0.50 VA
17	EI30/5.5	0.70 VA
18	EI30/8	1.20 VA
19	EI30/10.5	1.50 VA
20	EI30/11.5	1.80 VA
21	EI30/12.5	1.50 VA
22	EI30/12.5	1.90 VA
23	EI30/15.5	2.00 VA
24	EI30/15.5	2.10 VA
25	EI30/18	2.30 VA
26	EI30/24	2.60 VA
27	EI30/23	3.00 VA
28	EI30-EuP-Transformatoren <i>EI30-EuP-transformers</i>	
29	EI30/12.5 EuP	1.20 VA
30	EI30/12.5 EuP	1.50 VA
31	EI30/15.5 EuP	1.80 VA
32	EI30/15.5 EuP	2.00 VA
33	EI30/18 EuP	2.20 VA
34	EI30/23 EuP	2.80 VA

Seite/Page	Produkt/Product	Leistung/ Power
35	EI38 – EI54-Transformatoren <i>EI38 – EI54-transformers</i>	
36	EI38/7.5	2.50 VA
37 – 39	EI38/13.6	3.20 VA
40 – 42	EI38/13.6	4.50 VA
43	EI38/16.5	6.00 VA
44	EI42/8.5	3.00 VA
45 – 51	EI42/14.8	5.00 VA
52 – 58	EI42/14.8	6.00 VA
59	EI42/20.5	8.00 VA
60 – 63	EI48/16.8	10.00 VA
64 – 67	EI48/20.5	12.00 VA
68	EI48/25.5	15.00 VA
69	EI54/14	12.00 VA
70 – 77	EI54/18.8	16.00 VA
78 – 79	EI54/23	20.00 VA
80	EI54/25.5	23.00 VA
81	EI60 – EI96-Transformatoren <i>EI60 – EI96-transformers</i>	
82 – 85	EI60/21	24.00 VA
86	EI60/25.5	28.00 VA
87	EI60/30.5	32.00 VA
88	EI60/35	35.00 VA
89	EI66/23	34.00 VA
90	EI66/30	45.00 VA
91 – 93	EI66/34.7	50.00 VA
94	EI66/40	52.00 VA
95	EI78/27.5	55.00 VA
96	EI78/36.5	65.00 VA
97	EI78/40.5	80.00 VA
98	EI84/29.5	75.00 VA
99	EI84/43.5	100.00 VA
100	EI96/35.7	140.00 VA
101	EI96/45.7	180.00 VA
102	EI96/59.7	220.00 VA

Seite/Page	Produkt/Product	Leistung/ Power
103	UI21 – UI48-Transformatoren <i>UI21 – UI48-transformers</i>	
104	UI21/7.3	0.80 VA
105	UI21/7.3	1.00 VA
106	UI30/5.5	2.00 VA
107	UI30/5.5	3.00 VA
108	UI30/7.5	4.00 VA
109	UI30/10.5	6.00 VA
110	UI30/16.5	10.00 VA
111	UI30/26	16.00 VA
112	UI39/8	10.00 VA
113	UI39/10.2	14.00 VA
114	UI39/13.5	18.00 VA
115	UI39/17	24.00 VA
116	UI39/21	30.00 VA
117	UI48/17	40.00 VA
118	UI48/17	45.00 VA
119	UI48/26	60.00 VA
120	UI48/26	65.00 VA
121 – 125	Transformatoren mit spez. Abmessungen <i>Transformers with special dimensions</i>	
126 – 127	Ringkern-Transformatoren <i>Toroidal transformers</i>	
128 – 131	Steuer-Transformatoren <i>Control transformers</i>	
132 – 135	Netz-Transformatoren <i>Power-transformers</i>	
136	Netzdröseln <i>Line chokes</i>	
137	Ferrit Bauteile <i>Ferrite components</i>	
138	Spulen <i>Coils</i>	
139	Artikelnummer-Aufbau <i>Item number composition</i>	

Seite/Page	Produkt/Product	Leistung/ Power
140	Tampondruckverfahren <i>Pad printing process</i>	
141	Normungsorganisationen <i>Standards organizations</i>	
142	Prüfzeichen <i>Approvals</i>	
143 – 145	Zeichen und Symbole <i>Characters and symbols</i>	
146 – 148	Bestückungsplan Transformatoren <i>Pinout of transformers</i>	
149	Anschlusschema UI Transformatoren <i>Connection diagrams UI transformers</i>	
150	Mögliche Gehäuseformen <i>Possible types of housing</i>	
151	So finden Sie uns <i>How to reach us</i>	
152 – 153	Standorte TECH POWER ELECTRONICS Group <i>Locations TECH POWER ELECTRONICS Group</i>	



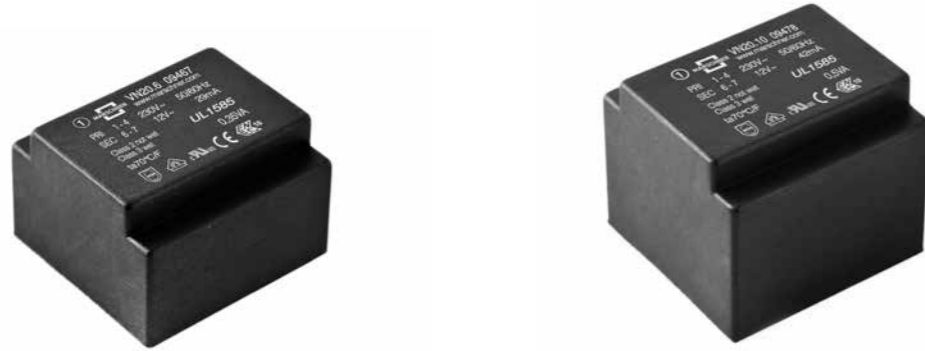

Entscheidende Vorteile unserer EE20-Transformatoren:

- kompakte Bauweise mit einem Leistungsbereich bis 0.5 VA
- minimale Bauhöhe
- unbedingt kurzschlussfest
- ausgezeichnetes Temperaturwechselverhalten durch Epoxyd-Vakuumverguss
- 100% stückgeprüft mit 4000 V PRI-SEC
- Temperatur-/Isolierstoffklasse ta 40°C/B, ta 70°C/B, ta 70°C/F
- höchste Sicherheit und Langlebigkeit
- VDE-, UL-, CSA-, ENEC10-Prüfzeichen
- Zweikammer-Wicklung
- hohe Stoßspannungsfestigkeit
- selbstverlöschendes Haubenmaterial
- optimal für den Einsatz auf Leiterplatten

Key advantages of our EE20-transformers:

- compact design with power range up to 0.5 VA
- minimal height
- inherently short circuit proof
- excellent temperature-change behavior owing to epoxy vacuum casting
- 100% unit checked with 4000 V PRI-SEC
- ambient temperature insulation class ta 40°C/B, ta 70°C/B, ta 70°C/F
- highest safety and lifetime
- VDE, UL, CSA, ENEC10 approvals
- split bobbin, two chamber winding
- high surge capability
- self-extinguishing case material
- optimal for PCB mounting

Sämtliche Baugrößen können wir nach Kundenwunsch anpassen:

- weitere PRI-SEC-Spannungen
- individuelle Leistungen
- unvergossene Ausführungen
- spezielle PIN-Belegung
- höhere Temperaturklassen

Customization of all sizes is possible:

- further PRI-SEC voltages
- individual power values
- unpotted versions
- special PIN configurations
- higher temperature classes

Typ Type	Abmessungen (B x T x H) [mm] Dimensions (L x W x H)	Leistung bei ta 70°C/F [VA] Power at ta 70°C/F
EE20/6,1	22.6 x 21.7 x 14.9	0.35
EE20/10,5	22.6 x 21.7 x 19.0	0.50

Typ/Type

EE20/6,1

Sicherheitstransformator / Kurzschlußfest
 VDE 0570 / EN 61558 / ENEC10
 UL 506 / UL 1585 / CSA geprüft
 Vakuum Epoxydverguss
 Stoßspannungsgeprüft
 Temperaturklasse ta70°C/F
 Cul-Gewicht: 7 g
 Gesamt-Gewicht: 24 g

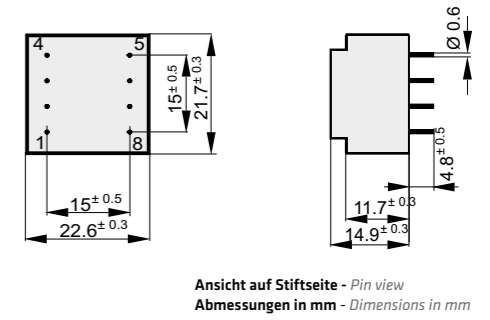

Nennleistung/Nominal power

0.35 VA

Safety transformer / Short-circuit-proof
 VDE 0570 / EN 61558 / ENEC10
 UL 506 / UL 1585 / CSA approved
 Vacuum epoxy casting
 Surge resistance approved
 Temperature class ta70°C/F
 Cul weight: 7 g
 Total weight: 24 g



Bestell Nr. Order No.	Primär [V] Primary	Sekundär [V] Secondary	Strom [mA] Current	Stiftbelegung Pin configuration	Leerlaufspannung [V] No load voltage	Prüfzeichen / Approvals		
						VDE	5085-2/3	5085-1/2
VN20.6/09464	230	4	87,5	1-4 / 6-7	7,50	●	●	
VN20.6/09465	230	6	58,3	1-4 / 6-7	9,90	●	●	
VN20.6/09466	230	9	38,8	1-4 / 6-7	14,70	●	●	
VN20.6/09467	230	12	29,1	1-4 / 6-7	20,00	●	●	
VN20.6/09468	230	15	23,3	1-4 / 6-7	26,10	●	●	
VN20.6/09469	230	18	19,4	1-4 / 6-7	30,90	●	●	
VN20.6/09470	230	24	14,5	1-4 / 6-7	36,10	●	●	
VN20.6/09471	230	2x6	2x29,1	1-4 / 5-6 + 7-8	2x10,50	●	●	
VN20.6/09472	230	2x9	2x19,4	1-4 / 5-6 + 7-8	2x15,40	●	●	
VN20.6/09473	230	2x12	2x14,5	1-4 / 5-6 + 7-8	2x20,20	●	●	
VN20.6/09474	230	2x15	2x11,6	1-4 / 5-6 + 7-8	2x25,20	●	●	
VN20.6/09435	230	2x18	2x9,7	1-4 / 5-6 + 7-8	2x31,10			●
VN20.6/09377	230	2x24	2x7,3	1-4 / 5-6 + 7-8	2x40,60			●

Trenntransformator / isolation transformer

Typ/Type

EE20/10,5

Sicherheitstransformator / Kurzschlußfest
 VDE 0570 / EN 61558 / ENEC10
 UL 506 / UL 1585 / CSA geprüft
 Vakuum Epoxydverguss
 Stoßspannungsgeprüft
 Temperaturklasse ta70°C/F
 Cul-Gewicht: 8 g
 Gesamt-Gewicht: 35 g

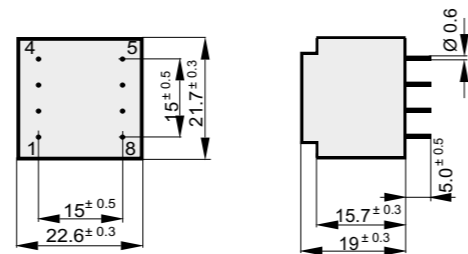

Ansicht auf Stiftseite - Pin view
 Abmessungen in mm - Dimensions in mm

Nennleistung/Nominal power

0.5 VA

Safety transformer / Short-circuit-proof
 VDE 0570 / EN 61558 / ENEC10
 UL 506 / UL 1585 / CSA approved
 Vacuum epoxy casting
 Surge resistance approved
 Temperature class ta70°C/F
 Cul weight: 8 g
 Total weight: 35 g



Bestell Nr. <i>Order No.</i>	Primär [V] <i>Primary</i>	Sekundär [V] <i>Secondary</i>	Strom [mA] <i>Current</i>	Stiftbelegung <i>Pin configuration</i>	Leerlaufspannung [V] <i>No load voltage</i>	Prüfzeichen / Approvals		
						VDE	5085-2/3	5085-1/2

VN20.10/09475	230	4	125	1-4 / 6-7	7,40	●	●	
VN20.10/09476	230	6	83,3	1-4 / 6-7	10,80	●	●	
VN20.10/09477	230	9	55,5	1-4 / 6-7	16,50	●	●	
VN20.10/09478	230	12	41,6	1-4 / 6-7	20,60	●	●	
VN20.10/09479	230	15	33,3	1-4 / 6-7	26,00	●	●	
VN20.10/09437	230	18	27,8	1-4 / 6-7	30,10	●		●
VN20.10/09383	230	24	20,8	1-4 / 6-7	41,10	●		●
VN20.10/09480	230	2x6	2x41,6	1-4 / 5-6 + 7-8	2x10,90	●	●	
VN20.10/09384	230	2x9	2x27,7	1-4 / 5-6 + 7-8	2x16,40	●		●
VN20.10/09385	230	2x12	2x20,8	1-4 / 5-6 + 7-8	2x20,60	●		●
VN20.10/09386	230	2x15	2x16,6	1-4 / 5-6 + 7-8	2x24,80			●
VN20.10/09440	230	2x18	2x13,8	1-4 / 5-6 + 7-8	2x28,90			●
VN20.10/09387	230	2x24	2x10,4	1-4 / 5-6 + 7-8	2x41,30			●

VN20.10/29475	115	4	125	1-4 / 6-7	7,40	●	●	
VN20.10/29476	115	6	83,3	1-4 / 6-7	10,80	●	●	
VN20.10/29477	115	9	55,5	1-4 / 6-7	16,50	●	●	
VN20.10/29478	115	12	41,6	1-4 / 6-7	20,60	●	●	
VN20.10/29479	115	15	33,3	1-4 / 6-7	26,00	●	●	
VN20.10/29437	115	18	27,8	1-4 / 6-7	30,10	●		●
VN20.10/29383	115	24	20,8	1-4 / 6-7	41,10	●		●
VN20.10/29480	115	2x6	2x41,6	1-4 / 5-6 + 7-8	2x10,90	●	●	
VN20.10/29384	115	2x9	2x27,7	1-4 / 5-6 + 7-8	2x16,40	●		●
VN20.10/29385	115	2x12	2x20,8	1-4 / 5-6 + 7-8	2x20,60	●		●
VN20.10/29386	115	2x15	2x16,6	1-4 / 5-6 + 7-8	2x24,80			●
VN20.10/29440	115	2x18	2x13,8	1-4 / 5-6 + 7-8	2x28,90			●
VN20.10/29387	115	2x24	2x10,4	1-4 / 5-6 + 7-8	2x41,30			●

Trenntransformator / isolation transformer

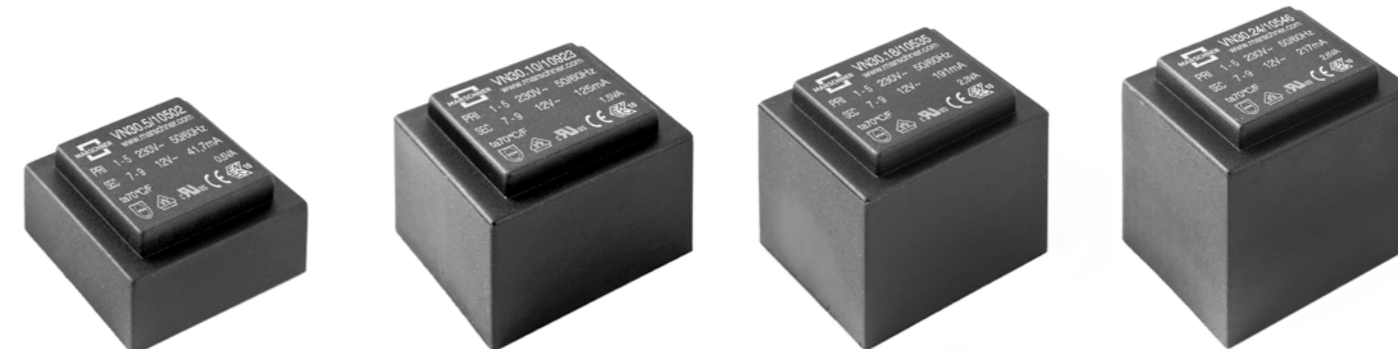

Entscheidende Vorteile unserer EI30-Transformatoren:

- kompakte Bauweise mit einem Leistungsbereich bis 3.0 VA
- minimale Bauhöhe
- unbedingt kurzschlussfest
- ausgezeichnetes Temperaturwechselverhalten durch Epoxyd-Vakuumverguss
- 100% stückgeprüft mit 4000 V PRI-SEC
- Temperatur-/Isolierstoffklasse ta 40°C/B, ta 70°C/B, ta 70°C/F
- höchste Sicherheit und Langlebigkeit
- VDE-, UL-, CSA-, ENEC10-Prüfzeichen
- Zweikammer-Wicklung
- hohe Stoßspannungsfestigkeit
- optimal für den Einsatz auf Leiterplatten
- VDE-Zertifikate für bestandene Glühdrahtprüfung vorhanden

Key advantages of our EI30-transformers:

- compact design with power range up to 3.0 VA
- minimal height
- inherently short circuit proof
- excellent temperature-change behavior owing to epoxy vacuum casting
- 100% unit checked with 4000 V PRI-SEC
- ambient temperature insulation class ta 40°C/B, ta 70°C/B, ta 70°C/F
- highest safety and lifetime
- VDE, UL, CSA, ENEC10 approvals
- split bobbin, two chamber winding
- high surge capability
- optimal for PCB mounting
- VDE certificates for passing of incandescent wire test available

Sämtliche Baugrößen können wir nach Kundenwunsch anpassen:

- weitere PRI-SEC-Spannungen
- individuelle Leistungen
- unvergossene Ausführungen
- spezielle PIN-Belegung
- höhere Temperaturklassen

Customization of all sizes is possible:

- further PRI-SEC voltages
- individual power values
- unpotted versions
- special PIN configurations
- higher temperature classes

Alle EI30 Transformatoren jetzt neu in Temperaturklasse F.

All EI30 transformers now also available in temperature class F.

Typ <i>Type</i>	Abmessungen (B x T x H) [mm] <i>Dimensions (L x W x H)</i>	Leistung bei ta 70°C/F [VA] <i>Power at ta 70°C/F</i>
EI30/5	32.5 x 27.5 x 14.9	0.5
EI30/5,5	32.5 x 27.5 x 15.3	0.7 NEU/NEW
EI30/8	32.5 x 27.5 x 18.8	1.2 NEU/NEW
EI30/10,5	32.5 x 27.5 x 22.0	1.5
EI30/11,5	32.5 x 27.5 x 22.0	1.8 NEU/NEW
EI30/12,5	32.5 x 27.5 x 24.0	1.5
EI30/12,5	32.5 x 27.5 x 24.0	1.9
EI30/15,5	32.5 x 27.5 x 26.5	2.0 NEU/NEW
EI30/15,5	32.5 x 27.5 x 26.5	2.1
EI30/18	32.5 x 27.5 x 29.5	2.3
EI30/24	32.5 x 27.5 x 34.8	2.6
EI30/23	32.5 x 27.5 x 34.0	3.0 NEU/NEW

EI30-EuP-Transformatoren finden Sie auf Seite 28
 You will find EI30-EuP-transformers on page 28

Typ/Type

EI30/5

Sicherheitstransformator / Kurzschlußfest
VDE 0570 / EN 61558 / ENEC10
 UL 506 / UL 1585 / CSA geprüft
 Vakuum Epoxydverguss
 Stoßspannungsgeprüft
 Temperaturklasse ta70°C/F
 Cul-Gewicht: 9 g
 Gesamt-Gewicht: 43 g

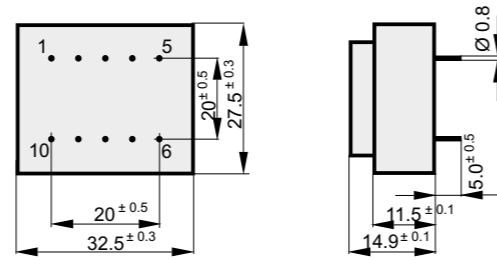

Ansicht auf Stiftseite - Pin view
 Abmessungen in mm - Dimensions in mm

Nennleistung/Nominal power

0.5 VA

Safety transformer / Short-circuit-proof
VDE 0570 / EN 61558 / ENEC10
 UL 506 / UL 1585 / CSA approved
 Vacuum epoxy casting
 Surge resistance approved
 Temperature class ta70°C/F
 Cul weight: 9 g
 Total weight: 43 g



Bestell Nr. <i>Order No.</i>	Primär [V] <i>Primary</i>	Sekundär [V] <i>Secondary</i>	Strom [mA] <i>Current</i>	Stiftbelegung <i>Pin configuration</i>	Leerlaufspannung [V] <i>No load voltage</i>	Prüfzeichen / Approvals		
						VDE	5085-2/3	5085-1/2

VN30.5/11031	230	6	83,0	1-5 / 7-9	9,70	●	●	
VN30.5/11032	230	9	55,0	1-5 / 7-9	14,40	●	●	
VN30.5/11033	230	12	41,0	1-5 / 7-9	20,50	●	●	
VN30.5/11034	230	15	33,0	1-5 / 7-9	24,60	●	●	
VN30.5/11109	230	18	27,5	1-5 / 7-9	27,00	●	●	
VN30.5/11274	230	24	20,0	1-5 / 7-9	37,00	●		●
VN30.5/11035	230	2x6	2x41,0	1-5 / 6-7+9-10	9,20 / 10,10	●	●	
VN30.5/11036	230	2x7,5	2x33,0	1-5 / 6-7+9-10	11,50 / 12,30	●	●	
VN30.5/11037	230	2x9	2x27,5	1-5 / 6-7+9-10	14,40 / 15,60	●	●	
VN30.5/11275	230	2x12	2x20,0	1-5 / 6-7+9-10	18,40 / 19,90	●		●
VN30.5/11276	230	2x15	2x16,5	1-5 / 6-7+9-10	22,90 / 24,70	●		●
VN30.5/11277	230	2x18	2x13,8	1-5 / 6-7+9-10	29,90 / 32,70			●
VN30.5/11278	230	2x24	2x10,4	1-5 / 6-7+9-10	38,60 / 41,10			●

VN30.5/21031	115	6	83,0	1-5 / 7-9	9,70	●	●	
VN30.5/21032	115	9	55,0	1-5 / 7-9	14,40	●	●	
VN30.5/21033	115	12	41,0	1-5 / 7-9	20,50	●	●	
VN30.5/21034	115	15	33,0	1-5 / 7-9	24,60	●	●	
VN30.5/21109	115	18	27,5	1-5 / 7-9	27,00	●	●	
VN30.5/21274	115	24	20,0	1-5 / 7-9	37,00	●		●
VN30.5/21035	115	2x6	2x41,0	1-5 / 6-7+9-10	9,20 / 10,10	●	●	
VN30.5/21036	115	2x7,5	2x33,0	1-5 / 6-7+9-10	11,50 / 12,30	●	●	
VN30.5/21037	115	2x9	2x27,5	1-5 / 6-7+9-10	14,40 / 15,60	●	●	
VN30.5/21275	115	2x12	2x20,0	1-5 / 6-7+9-10	18,40 / 19,90	●		●
VN30.5/21276	115	2x15	2x16,5	1-5 / 6-7+9-10	22,90 / 24,70	●		●
VN30.5/21277	115	2x18	2x13,8	1-5 / 6-7+9-10	29,90 / 32,70			●
VN30.5/21278	115	2x24	2x10,4	1-5 / 6-7+9-10	38,60 / 41,10			●

Trenntransformator / isolation transformer

Typ/Type

EI30/5,5

Sicherheitstransformator / Kurzschlußfest
VDE 0570 / EN 61558 / ENEC10 geprüft
 Vakuum Epoxydverguss
 Stoßspannungsgeprüft
 Temperaturklasse ta70°C/F
 Cul-Gewicht: 10 g
 Gesamt-Gewicht: 38 g

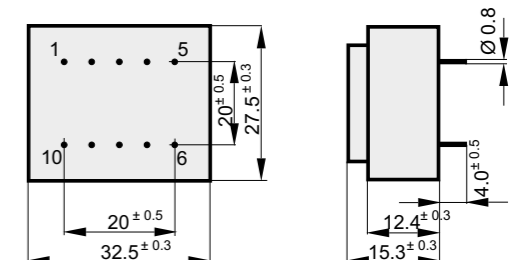

Ansicht auf Stiftseite - Pin view
 Abmessungen in mm - Dimensions in mm

Nennleistung/Nominal power

0.7 VA

Safety transformer / Short-circuit-proof
VDE 0570 / EN 61558 / ENEC10 approved
 Vacuum epoxy casting
 Surge resistance approved
 Temperature class ta70°C/F
 Cul weight: 10 g
 Total weight: 38 g



Bestell Nr. <i>Order No.</i>	Primär [V] <i>Primary</i>	Sekundär [V] <i>Secondary</i>	Strom [mA] <i>Current</i>	Stiftbelegung <i>Pin configuration</i>	Leerlaufspannung [V] <i>No load voltage</i>	Prüfzeichen / Approvals		
						VDE	5085-2/3	5085-1/2

VN30.5,5/11159	230	6	117,0	1-5 / 7-9	9,80	●		
VN30.5,5/11160	230	9	77,7	1-5 / 7-9	14,50	●		
VN30.5,5/11161	230	12	58,3	1-5 / 7-9	19,40	●		
VN30.5,5/11162	230	15	46,6	1-5 / 7-9	22,80	●		
VN30.5,5/11163	230	18	38,8	1-5 / 7-9	29,60	●		
VN30.5,5/11164	230	24	29,2	1-5 / 7-9	36,40	●		
VN30.5,5/11165	230	2x6	2x58,3	1-5 / 6-7+9-10	9,40 / 10,20	●		
VN30.5,5/11166	230	2x9	2x38,8	1-5 / 6-7+9-10	13,90 / 15,20	●		
VN30.5,5/11167	230	2x12	2x29,2	1-5 / 6-7+9-10	18,60 / 20,30	●		
VN30.5,5/11168	230	2x15	2x23,3	1-5 / 6-7+9-10	22,89 / 25,40	●		
VN30.5,5/11279	230	2x18	2x19,4	1-5 / 6-7+9-10	28,00 / 31,10			●
VN30.5,5/11280	230	2x24	2x14,6	1-5 / 6-7+9-10	37,00 / 41,00			●

VN30.5,5/21159	115	6	117,0	1-5 / 7-9	9,80	●		
VN30.5,5/21160	115	9	77,7	1-5 / 7-9	14,50	●		
VN30.5,5/21161	115	12	58,3	1-5 / 7-9	19,40	●		
VN30.5,5/21162	115	15	46,6	1-5 / 7-9	22,80	●		
VN30.5,5/21163	115	18	38,8	1-5 / 7-9	29,60	●		
VN30.5,5/21164	115	24	29,2	1-5 / 7-9	36,40	●		
VN30.5,5/21165	115	2x6	2x58,3	1-5 / 6-7+9-10	9,40 / 10,20	●		
VN30.5,5/21166	115	2x9	2x38,8	1-5 / 6-7+9-10	13,90 / 15,20	●		
VN30.5,5/21167	115	2x12	2x29,2	1-5 / 6-7+9-10	18,60 / 20,30	●		
VN30.5,5/21168	115	2x15	2x23,3	1-5 / 6-7+9-10	22,89 / 25,40	●		
VN30.5,5/21279	115	2x18	2x19,4	1-5 / 6-7+9-10	28,00 / 31,10			●
VN30.5,5/21280	115	2x24	2x14,6	1-5 / 6-7+9-10	37,00 / 41,00			●

Trenntransformator / isolation transformer

Typ/Type

EI30/8

Sicherheitstransformator / Kurzschlußfest
 VDE 0570 / EN 61558 / ENEC10
 UL 506 / CSA geprüft
 Vakuum Epoxydverguss
 Stoßspannungsgeprüft
 Temperaturklasse ta70°C/F
 Cul-Gewicht: 11 g
 Gesamt-Gewicht: 55 g

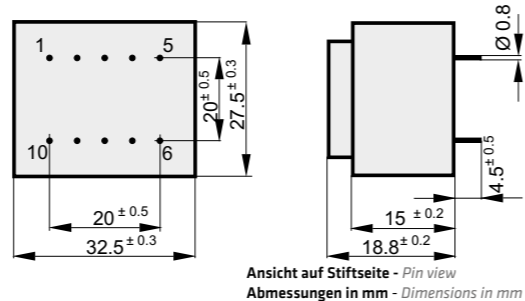

Nennleistung/Nominal power

1.2 VA

Safety transformer / Short-circuit-proof
 VDE 0570 / EN 61558 / ENEC10
 UL 506 / CSA approved
 Vacuum epoxy casting
 Surge resistance approved
 Temperature class ta70°C/F
 Cul weight: 11 g
 Total weight: 55 g



Bestell Nr. <i>Order No.</i>	Primär [V] <i>Primary</i>	Sekundär [V] <i>Secondary</i>	Strom [mA] <i>Current</i>	Stiftbelegung <i>Pin configuration</i>	Leerlaufspannung [V] <i>No load voltage</i>	Prüfzeichen / Approvals		
						VDE	5085-2/3	5085-1/2

VN30.8/11147	230	6	200	1-5 / 7-9	10,34	●		●
VN30.8/11148	230	9	133	1-5 / 7-9	15,69	●		●
VN30.8/11149	230	12	100	1-5 / 7-9	20,80	●		●
VN30.8/11150	230	15	80	1-5 / 7-9	26,05	●		●
VN30.8/11151	230	18	67	1-5 / 7-9	31,90	●		●
VN30.8/11152	230	24	50	1-5 / 7-9	41,29	●		●
VN30.8/11153	230	2x6	2x100	1-5 / 6-7+9-10	10,25 / 10,75	●		●
VN30.8/11154	230	2x9	2x67	1-5 / 6-7+9-10	15,40 / 16,40	●		●
VN30.8/11155	230	2x12	2x50	1-5 / 6-7+9-10	18,60 / 19,60	●		●
VN30.8/11156	230	2x15	2x40	1-5 / 6-7+9-10	24,40 / 26,50	●		●
VN30.8/11157	230	2x18	2x33	1-5 / 6-7+9-10	30,00 / 33,00	●		●
VN30.8/11158	230	2x24	2x25	1-5 / 6-7+9-10	39,80 / 43,80	●		●

VN30.8/21147	115	6	200	1-5 / 7-9	10,34	●		●
VN30.8/21148	115	9	133	1-5 / 7-9	15,69	●		●
VN30.8/21149	115	12	100	1-5 / 7-9	20,80	●		●
VN30.8/21150	115	15	80	1-5 / 7-9	26,05	●		●
VN30.8/21151	115	18	67	1-5 / 7-9	31,90	●		●
VN30.8/21152	115	24	50	1-5 / 7-9	41,29	●		●
VN30.8/21153	115	2x6	2x100	1-5 / 6-7+9-10	10,25 / 10,75	●		●
VN30.8/21154	115	2x9	2x67	1-5 / 6-7+9-10	15,40 / 16,40	●		●
VN30.8/21155	115	2x12	2x50	1-5 / 6-7+9-10	18,60 / 19,60	●		●
VN30.8/21156	115	2x15	2x40	1-5 / 6-7+9-10	24,40 / 26,50	●		●
VN30.8/21157	115	2x18	2x33	1-5 / 6-7+9-10	30,00 / 33,00	●		●
VN30.8/21158	115	2x24	2x25	1-5 / 6-7+9-10	39,80 / 43,80	●		●

● Trenntransformator / isolation transformer

Typ/Type

EI30/10,5

Sicherheitstransformator / Kurzschlußfest
 VDE 0570 / EN 61558 / ENEC10
 UL 506 / UL 1585 / CSA geprüft
 Vakuum Epoxydverguss
 Stoßspannungsgeprüft
 Temperaturklasse ta70°C/F
 Cul-Gewicht: 12 g
 Gesamt-Gewicht: 75 g

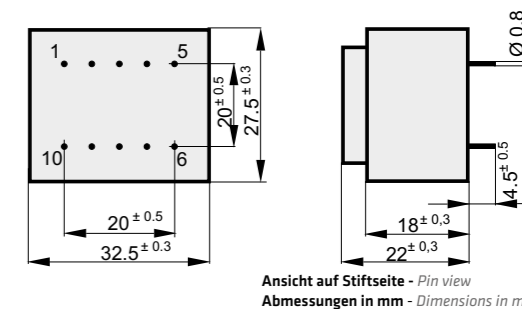

Nennleistung/Nominal power

1.5 VA

Safety transformer / Short-circuit-proof
 VDE 0570 / EN 61558 / ENEC10
 UL 506 / UL 1585 / CSA approved
 Vacuum epoxy casting
 Surge resistance approved
 Temperature class ta70°C/F
 Cul weight: 12 g
 Total weight: 75 g



Bestell Nr. <i>Order No.</i>	Primär [V] <i>Primary</i>	Sekundär [V] <i>Secondary</i>	Strom [mA] <i>Current</i>	Stiftbelegung <i>Pin configuration</i>	Leerlaufspannung [V] <i>No load voltage</i>	Prüfzeichen / Approvals		
						VDE	5085-2/3	5085-1/2

VN30.10/10939-1	230	6	250	1-5 / 7-9	11,10	●	●	
VN30.10/10922-1	230	9	166	1-5 / 7-9	15,70	●	●	
VN30.10/10923-1	230	12	125	1-5 / 7-9	20,80	●	●	
VN30.10/10924-1	230	15	100	1-5 / 7-9	25,70	●	●	
VN30.10/10925	230	18	83,0	1-5 / 7-9	32,40	●		●
VN30.10/10962	230	24	62,5	1-5 / 7-9	43,70	●		●
VN30.10/10963-1	230	2x6	2x125	1-5 / 6-7+9-10	9,80 / 10,70	●	●	
VN30.10/10964	230	2x9	2x83,0	1-5 / 6-7+9-10	15,40 / 16,85	●		●
VN30.10/10958	230	2x12	2x62,5	1-5 / 6-7+9-10	20,80 / 20,48	●		●
VN30.10/10965	230	2x15	2x50,0	1-5 / 6-7+9-10	23,70 / 25,50	●		●
VN30.10/10966	230	2x18	2x41,6	1-5 / 6-7+9-10	28,80 / 30,80	●		●
VN30.10/10967	230	2x24	2x31,2	1-5 / 6-7+9-10	38,20 / 41,30	●		●

VN30.10/20939-1	115	6	250	1-5 / 7-9	11,10	●	●	
VN30.10/20922-1	115	9	166	1-5 / 7-9	15,70	●	●	
VN30.10/20923-1	115	12	125	1-5 / 7-9	20,80	●	●	
VN30.10/20924-1	115	15	100	1-5 / 7-9	25,70	●	●	
VN30.10/20925	115	18	83,0	1-5 / 7-9	32,40	●		●
VN30.10/20962	115	24	62,5	1-5 / 7-9	43,70	●		●
VN30.10/20963-1	115	2x6	2x125	1-5 / 6-7+9-10	9,80 / 10,70	●	●	
VN30.10/20964	115	2x9	2x83,0	1-5 / 6-7+9-10	15,40 / 16,85	●		●
VN30.10/20958	115	2x12	2x62,5	1-5 / 6-7+9-10	20,80 / 20,48	●		●
VN30.10/20965	115	2x15	2x50,0	1-5 / 6-7+9-10	23,70 / 25,50	●		●
VN30.10/20966	115	2x18	2x41,6	1-5 / 6-7+9-10	28,80 / 30,80	●		●
VN30.10/20967	115	2x24	2x31,2	1-5 / 6-7+9-10	38,20 / 41,30	●		●

● Trenntransformator / isolation transformer

Typ/Type

EI30/11,5

Sicherheitstransformator / Kurzschlußfest
 VDE 0570 / EN 61558 / ENEC10
 UL 506 / CSA geprüft
 Vakuum Epoxydverguss
 Stoßspannungsgeprüft
 Temperaturklasse ta70°C/F
 Cul-Gewicht: 14 g
 Gesamt-Gewicht: 80 g

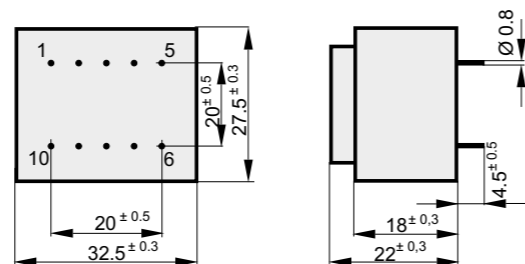

Ansicht auf Stiftseite - Pin view
 Abmessungen in mm - Dimensions in mm

Nennleistung/Nominal power

1.8 VA

Safety transformer / Short-circuit-proof
 VDE 0570 / EN 61558 / ENEC10
 UL 506 / CSA approved
 Vacuum epoxy casting
 Surge resistance approved
 Temperature class ta70°C/F
 Cul weight: 14 g
 Total weight: 80 g



Bestell Nr. <i>Order No.</i>	Primär [V] <i>Primary</i>	Sekundär [V] <i>Secondary</i>	Strom [mA] <i>Current</i>	Stiftbelegung <i>Pin configuration</i>	Leerlaufspannung [V] <i>No load voltage</i>	Prüfzeichen / Approvals		
						VDE	5085-2/3	5085-1/2

VN30.11/11303	230	6	300	1-5 / 7-9	9,90	●		●
VN30.11/11305	230	9	200	1-5 / 7-9	15,00	●		●
VN30.11/11306	230	12	150	1-5 / 7-9	19,70	●		●
VN30.11/11307	230	15	120	1-5 / 7-9	24,80	●		●
VN30.11/11308	230	18	100	1-5 / 7-9	29,50	●		●
VN30.11/11309	230	24	75	1-5 / 7-9	38,70	●		●
VN30.11/11310	230	2x6	2x150	1-5 / 6-7+9-10	2x10,00	●		●
VN30.11/11311	230	2x7,5	2x120	1-5 / 6-7+9-10	2x12,50	●		●
VN30.11/11312	230	2x9	2x100	1-5 / 6-7+9-10	2x14,90	●		●
VN30.11/11313	230	2x12	2x75	1-5 / 6-7+9-10	2x19,70	●		●
VN30.11/11314	230	2x15	2x60	1-5 / 6-7+9-10	2x24,70	●		●
VN30.11/11319	230	2x18	2x50	1-5 / 6-7+9-10	2x29,33	●		●
VN30.11/11320	230	2x24	2x37,5	1-5 / 6-7+9-10	2x38,60	●		●

VN30.11/21303	115	6	300	1-5 / 7-9	9,90	●		●
VN30.11/21305	115	9	200	1-5 / 7-9	15,00	●		●
VN30.11/21306	115	12	150	1-5 / 7-9	19,70	●		●
VN30.11/21307	115	15	120	1-5 / 7-9	24,80	●		●
VN30.11/21308	115	18	100	1-5 / 7-9	29,50	●		●
VN30.11/21309	115	24	75	1-5 / 7-9	38,70	●		●
VN30.11/21310	115	2x6	2x150	1-5 / 6-7+9-10	2x10,00	●		●
VN30.11/21311	115	2x7,5	2x120	1-5 / 6-7+9-10	2x12,50	●		●
VN30.11/21312	115	2x9	2x100	1-5 / 6-7+9-10	2x14,90	●		●
VN30.11/21313	115	2x12	2x75	1-5 / 6-7+9-10	2x19,70	●		●
VN30.11/21314	115	2x15	2x60	1-5 / 6-7+9-10	2x24,70	●		●
VN30.11/21315	115	2x18	2x50	1-5 / 6-7+9-10	2x29,33	●		●
VN30.11/21316	115	2x24	2x37,5	1-5 / 6-7+9-10	2x38,60	●		●

Trenntransformator / isolation transformer

Typ/Type

EI30/12,5

Sicherheitstransformator / Kurzschlußfest
 VDE 0570 / EN 61558 / ENEC10
 UL 506 / CSA geprüft
 Vakuum Epoxydverguss
 Stoßspannungsgeprüft
 Temperaturklasse ta70°C/F
 Cul-Gewicht: 13 g
 Gesamt-Gewicht: 85 g

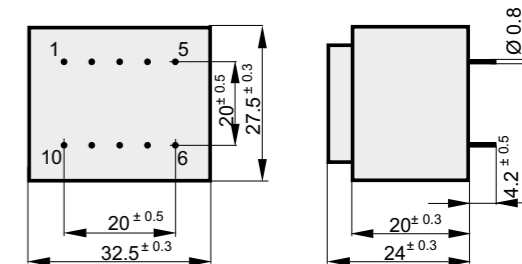

Ansicht auf Stiftseite - Pin view
 Abmessungen in mm - Dimensions in mm

Nennleistung/Nominal power

1.5 VA

Safety transformer / Short-circuit-proof
 VDE 0570 / EN 61558 / ENEC10
 UL 506 / CSA approved
 Vacuum epoxy casting
 Surge resistance approved
 Temperature class ta70°C/F
 Cul weight: 13 g
 Total weight: 85 g



Bestell Nr. <i>Order No.</i>	Primär [V] <i>Primary</i>	Sekundär [V] <i>Secondary</i>	Strom [mA] <i>Current</i>	Stiftbelegung <i>Pin configuration</i>	Leerlaufspannung [V] <i>No load voltage</i>	Prüfzeichen / Approvals		
						VDE	5085-2/3	5085-1/2

VN30.12/10511	230	6	250	1-5 / 7-9	9,10	●	●	
VN30.12/10512	230	9	166	1-5 / 7-9	13,90	●	●	
VN30.12/10513	230	12	125	1-5 / 7-9	18,60	●	●	
VN30.12/10514	230	15	100	1-5 / 7-9	23,00	●	●	
VN30.12/10515	230	18	83,0	1-5 / 7-9	27,60	●	●	
VN30.12/10516	230	24	62,5	1-5 / 7-9	36,50	●		●
VN30.12/10517	230	2x6	2x125	1-5 / 6-7+9-10	9,00 / 9,30	●	●	
VN30.12/10518	230	2x7,5	2x100	1-5 / 6-7+9-10	11,20 / 11,60	●	●	
VN30.12/10519	230	2x9	2x83	1-5 / 6-7+9-10	13,30 / 13,80	●	●	
VN30.12/10520	230	2x12	2x62,5	1-5 / 6-7+9-10	18,00 / 18,50	●		●
VN30.12/10521	230	2x15	2x50	1-5 / 6-7+9-10	23,20 / 24,80	●		●
VN30.12/10968	230	2x18	2x41,6	1-5 / 6-7+9-10	26,90 / 28,40	●		●
VN30.12/10969	230	2x24	2x31,2	1-5 / 6-7+9-10	36,90 / 38,90	●		●

VN30.12/20511	115	6	250	1-5 / 7-9	9,10	●	●	
VN30.12/20512	115	9	166	1-5 / 7-9	13,90	●	●	
VN30.12/20513	115	12	125	1-5 / 7-9	18,60	●	●	
VN30.12/20514	115	15	100	1-5 / 7-9	23,00	●	●	
VN30.12/20515	115	18	83,0	1-5 / 7-9	27,60	●	●	
VN30.12/20516	115	24	62,5	1-5 / 7-9	36,50	●		●
VN30.12/20517	115	2x6	2x125	1-5 / 6-7+9-10	9,00 / 9,30	●	●	
VN30.12/20518	115	2x7,5	2x100	1-5 / 6-7+9-10	11,20 / 11,60	●	●	
VN30.12/20519	115	2x9	2x83,0	1-5 / 6-7+9-10	13,30 / 13,80	●	●	
VN30.12/20520	115	2x12	2x62,5	1-5 / 6-7+9-10	18,00 / 18,50	●		●
VN30.12/20521	115	2x15	2x50,0	1-5 / 6-7+9-10	23,20 / 24,80	●		●
VN30.12/20968	115	2x18	2x41,6	1-5 / 6-7+9-10	26,90 / 28,40	●		●
VN30.12/20969	115	2x24	2x31,2	1-5 / 6-7+9-10	36,90 / 38,90	●		●

Trenntransformator / isolation transformer

Typ/Type

EI30/12,5

Sicherheitstransformator / Kurzschlußfest
 VDE 0570 / EN 61558 / ENEC10
 UL 506 / UL 1585 / CSA geprüft
 Vakuum Epoxydverguss
 Stoßspannungsgeprüft
 Temperaturklasse ta70°C/F
 Cul-Gewicht: 13 g
 Gesamt-Gewicht: 85 g

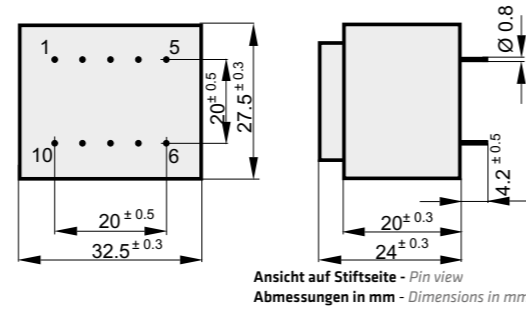

Nennleistung/Nominal power

1.9 VA

Safety transformer / Short-circuit-proof
 VDE 0570 / EN 61558 / ENEC10
 UL 506 / UL 1585 / CSA approved
 Vacuum epoxy casting
 Surge resistance approved
 Temperature class ta70°C/F
 Cul weight: 13 g
 Total weight: 85 g



Bestell Nr. <i>Order No.</i>	Primär [V] <i>Primary</i>	Sekundär [V] <i>Secondary</i>	Strom [mA] <i>Current</i>	Stiftbelegung <i>Pin configuration</i>	Leerlaufspannung [V] <i>No load voltage</i>	Prüfzeichen / Approvals		
						VDE	5085-2/3	5085-1/2

VN30.12/11051	230	6	317	1-5 / 7-9	8,98	●	●	
VN30.12/11052	230	9	211	1-5 / 7-9	13,15	●	●	
VN30.12/11053	230	12	158	1-5 / 7-9	17,60	●	●	
VN30.12/11054	230	15	127	1-5 / 7-9	22,40	●	●	
VN30.12/11071	230	18	106	1-5 / 7-9	26,30	●	●	
VN30.12/11321	230	24	79,0	1-5 / 7-9	35,00	●		
VN30.12/11055	230	2x6	2x158	1-5 / 6-7+9-10	8,80 / 9,12	●	●	
VN30.12/11056	230	2x7,5	2x127	1-5 / 6-7+9-10	11,18 / 11,53	●	●	
VN30.12/11057	230	2x9	2x106	1-5 / 6-7+9-10	13,15 / 13,60	●	●	
VN30.12/11322	230	2x12	2x79	1-5 / 6-7+9-10	17,50 / 18,15	●		
VN30.12/11323	230	2x15	2x63	1-5 / 6-7+9-10	21,88 / 22,48	●		
VN30.12/11324	230	2x18	2x53	1-5 / 6-7+9-10	26,18 / 27,25	●		
VN30.12/11325	230	2x24	2x40	1-5 / 6-7+9-10	35,10 / 36,60	●		

VN30.12/21051	115	6	317	1-5 / 7-9	8,98	●	●	
VN30.12/21052	115	9	211	1-5 / 7-9	13,15	●	●	
VN30.12/21053	115	12	158	1-5 / 7-9	17,60	●	●	
VN30.12/21054	115	15	127	1-5 / 7-9	22,40	●	●	
VN30.12/21071	115	18	106	1-5 / 7-9	26,30	●	●	
VN30.12/21073	115	24	79,0	1-5 / 7-9	35,00	●		
VN30.12/21055	115	2x6	2x158	1-5 / 6-7+9-10	8,80 / 9,12	●	●	
VN30.12/21056	115	2x7,5	2x127	1-5 / 6-7+9-10	11,18 / 11,53	●	●	
VN30.12/21057	115	2x9	2x106	1-5 / 6-7+9-10	13,15 / 13,60	●	●	
VN30.12/21074	115	2x12	2x79	1-5 / 6-7+9-10	17,50 / 18,15	●		
VN30.12/21075	115	2x15	2x63	1-5 / 6-7+9-10	21,88 / 22,48	●		
VN30.12/21076	115	2x18	2x53	1-5 / 6-7+9-10	26,18 / 27,25	●		
VN30.12/21077	115	2x24	2x40	1-5 / 6-7+9-10	35,10 / 36,60	●		

Trenntransformator / isolation transformer

Typ/Type

EI30/15,5

Sicherheitstransformator / Kurzschlußfest
 VDE 0570 / EN 61558
 ENEC10 / UL 506 / CSA geprüft
 Vakuum Epoxydverguss
 Stoßspannungsgeprüft
 Temperaturklasse ta70°C/F
 Cul-Gewicht: 15 g
 Gesamt-Gewicht: 97 g

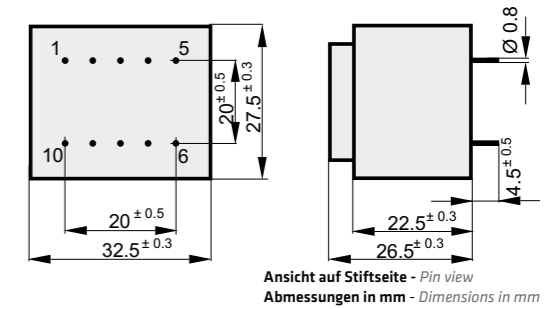

Nennleistung/Nominal power

2.0 VA

Safety transformer / Short-circuit-proof
 VDE 0570 / EN 61558 / ENEC10
 UL 506 / CSA approved
 Vacuum epoxy casting
 Surge resistance approved
 Temperature class ta70°C/F
 Cul weight: 15 g
 Total weight: 97 g



Bestell Nr. <i>Order No.</i>	Primär [V] <i>Primary</i>	Sekundär [V] <i>Secondary</i>	Strom [mA] <i>Current</i>	Stiftbelegung <i>Pin configuration</i>	Leerlaufspannung [V] <i>No load voltage</i>	Prüfzeichen / Approvals		
						VDE	5085-2/3	5085-1/2

VN30.15/10522	230	6	333	1-5 / 7-9	10,10	●		●
VN30.15/10523	230	9	222	1-5 / 7-9	15,70	●		●
VN30.15/10524	230	12	166	1-5 / 7-9	20,60	●		●
VN30.15/10525	230	15	133	1-5 / 7-9	26,40	●		●
VN30.15/10526	230	18	111	1-5 / 7-9	30,30	●		●
VN30.15/10527	230	24	83	1-5 / 7-9	39,70	●		●
VN30.15/10528	230	2x6	2x166	1-5 / 6-7+9-10	10,20 / 10,40	●		●
VN30.15/10529	230	2x7,5	2x133	1-5 / 6-7+9-10	12,60 / 13,70	●		●
VN30.15/10530	230	2x9	2x111	1-5 / 6-7+9-10	16,00 / 17,20	●		●
VN30.15/10531	230	2x12	2x83	1-5 / 6-7+9-10	19,50 / 20,40	●		●
VN30.15/10532	230	2x15	2x66	1-5 / 6-7+9-10	23,50 / 24,60	●		●
VN30.15/10970	230	2x18	2x55	1-5 / 6-7+9-10	28,80 / 30,10	●		●
VN30.15/10971	230	2x24	2x41	1-5 / 6-7+9-10	37,70 / 39,20	●		●

VN30.15/20522	115	6	333	1-5 / 7-9	10,10	●		●
VN30.15/20523	115	9	222	1-5 / 7-9	15,70	●		●
VN30.15/20524	115	12	166	1-5 / 7-9	20,60	●		●
VN30.15/20525	115	15	133	1-5 / 7-9	26,40	●		●
VN30.15/20526	115	18	111	1-5 / 7-9	30,30	●		●
VN30.15/20527	115	24	83	1-5 / 7-9	39,70	●		●
VN30.15/20528	115	2x6	2x166	1-5 / 6-7+9-10	10,20 / 10,40	●		●
VN30.15/20529	115	2x7,5	2x133	1-5 / 6-7+9-10	12,60 / 13,70	●		●
VN30.15/20530	115	2x9	2x111	1-5 / 6-7+9-10	16,00 / 17,20	●		●
VN30.15/20531	115	2x12	2x83	1-5 / 6-7+9-10	19,50 / 20,40	●		●
VN30.15/20532	115	2x15	2x66	1-5 / 6-7+9-10	23,50 / 24,60	●		●
VN30.15/20970	115	2x18	2x55	1-5 / 6-7+9-10	28,80 / 30,10	●		●
VN30.15/20971	115	2x24	2x41	1-5 / 6-7+9-10	37,70 / 39,20	●		●

Trenntransformator / isolation transformer

Typ/Type

EI30/15,5

Sicherheitstransformator / Kurzschlußfest
 VDE 0570 / EN 61558 / ENEC10 geprüft
 Vakuum Epoxydverguss
 Stoßspannungsgeprüft
 Temperaturklasse ta70°C/F
 Cul-Gewicht: 15 g
 Gesamt-Gewicht: 97 g

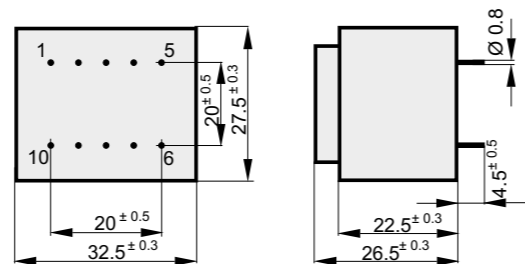

Ansicht auf Stiftseite - Pin view
 Abmessungen in mm - Dimensions in mm

Nennleistung/Nominal power

2.1 VA

Safety transformer / Short-circuit-proof
 VDE 0570 / EN 61558 / ENEC10 approved
 Vacuum epoxy casting
 Surge resistance approved
 Temperature class ta70°C/F
 Cul weight: 15 g
 Total weight: 97 g



Bestell Nr. <i>Order No.</i>	Primär [V] <i>Primary</i>	Sekundär [V] <i>Secondary</i>	Strom [mA] <i>Current</i>	Stiftbelegung <i>Pin configuration</i>	Leerlaufspannung [V] <i>No load voltage</i>	Prüfzeichen / Approvals		
						VDE	5085-2/3	5085-1/2

VN30.15/11261	230	6	350	1-5 / 7-9	10,23	●		
VN30.15/11262	230	9	233	1-5 / 7-9	15,36	●		
VN30.15/11263	230	12	175	1-5 / 7-9	20,94	●		
VN30.15/11264	230	15	140	1-5 / 7-9	26,35	●		
VN30.15/11265	230	18	117	1-5 / 7-9	33,00	●		
VN30.15/11266	230	24	87,5	1-5 / 7-9	36,95	●		
VN30.15/11267	230	2x6	2x175	1-5 / 6-7+9-10	2x10,85	●		
VN30.15/11268	230	2x7,5	2x140	1-5 / 6-7+9-10	2x13,60	●		
VN30.15/11269	230	2x9	2x117	1-5 / 6-7+9-10	2x15,75	●		
VN30.15/11270	230	2x12	2x87,5	1-5 / 6-7+9-10	2x21,60	●		
VN30.15/11271	230	2x15	2x70,0	1-5 / 6-7+9-10	2x26,25	●		
VN30.15/11272	230	2x18	2x58,3	1-5 / 6-7+9-10	2x31,55	●		
VN30.15/11273	230	2x24	2x43,8	1-5 / 6-7+9-10	2x36,50	●		

VN30.15/21261	115	6	350	1-5 / 7-9	10,23	●		
VN30.15/21262	115	9	233	1-5 / 7-9	15,36	●		
VN30.15/21263	115	12	175	1-5 / 7-9	20,94	●		
VN30.15/21264	115	15	140	1-5 / 7-9	26,35	●		
VN30.15/21265	115	18	117	1-5 / 7-9	33,00	●		
VN30.15/21266	115	24	87,5	1-5 / 7-9	36,95	●		
VN30.15/21267	115	2x6	2x175	1-5 / 6-7+9-10	2x10,85	●		
VN30.15/21268	115	2x7,5	2x140	1-5 / 6-7+9-10	2x13,60	●		
VN30.15/21269	115	2x9	2x117	1-5 / 6-7+9-10	2x15,75	●		
VN30.15/21270	115	2x12	2x87,5	1-5 / 6-7+9-10	2x21,60	●		
VN30.15/21271	115	2x15	2x70,0	1-5 / 6-7+9-10	2x26,25	●		
VN30.15/21272	115	2x18	2x58,3	1-5 / 6-7+9-10	2x31,55	●		
VN30.15/21273	115	2x24	2x43,8	1-5 / 6-7+9-10	2x36,50	●		

● Trenntransformator / isolation transformer

Typ/Type

EI30/18

Sicherheitstransformator / Kurzschlußfest
 VDE 0570 / EN 61558 / ENEC10
 UL 506 / CSA geprüft
 Vakuum Epoxydverguss
 Stoßspannungsgeprüft
 Temperaturklasse ta70°C/F
 Cul-Gewicht: 18 g
 Gesamt-Gewicht: 115 g

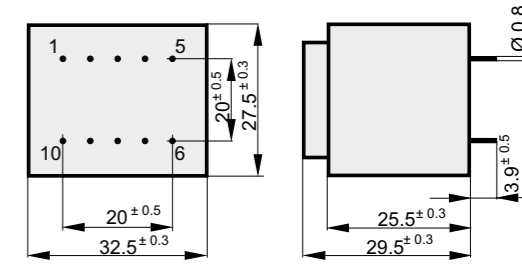

Ansicht auf Stiftseite - Pin view
 Abmessungen in mm - Dimensions in mm

Nennleistung/Nominal power

2.3 VA

Safety transformer / Short-circuit-proof
 VDE 0570 / EN 61558 / ENEC10
 UL 506 / CSA approved
 Vacuum epoxy casting
 Surge resistance approved
 Temperature class ta70°C/F
 Cul weight: 18 g
 Total weight: 115 g

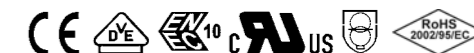

Bestell Nr. <i>Order No.</i>	Primär [V] <i>Primary</i>	Sekundär [V] <i>Secondary</i>	Strom [mA] <i>Current</i>	Stiftbelegung <i>Pin configuration</i>	Leerlaufspannung [V] <i>No load voltage</i>	Prüfzeichen / Approvals		
						VDE	5085-2/3	5085-1/2

VN30.18/10533	230	6	383	1-5 / 7-9	10,60	●		●
VN30.18/10534	230	9	255	1-5 / 7-9	14,30	●		●
VN30.18/10535	230	12	191	1-5 / 7-9	19,80	●		●
VN30.18/10536	230	15	153	1-5 / 7-9	25,40	●		●
VN30.18/10537	230	18	127	1-5 / 7-9	28,40	●		●
VN30.18/10538	230	24	95	1-5 / 7-9	40,00	●		●
VN30.18/10539	230	2x6	2x191	1-5 / 6-7+9-10	9,60 / 10,13	●		●
VN30.18/10540	230	2x7,5	2x153	1-5 / 6-7+9-10	12,40 / 13,00	●		●
VN30.18/10541	230	2x9	2x127	1-5 / 6-7+9-10	14,00 / 14,40	●		●
VN30.18/10542	230	2x12	2x95	1-5 / 6-7+9-10	19,50 / 20,50	●		●
VN30.18/10543	230	2x15	2x76	1-5 / 6-7+9-10	24,20 / 25,50	●		●
VN30.18/10972	230	2x18	2x63	1-5 / 6-7+9-10	27,40 / 28,60	●		●
VN30.18/10973	230	2x24	2x47	1-5 / 6-7+9-10	36,90 / 38,70	●		●

VN30.18/20533	115	6	383	1-5 / 7-9	10,60	●		●
VN30.18/20534	115	9	255	1-5 / 7-9	14,30	●		●
VN30.18/20535	115	12	191	1-5 / 7-9	19,80	●		●
VN30.18/20536	115	15	153	1-5 / 7-9	25,40	●		●
VN30.18/20537	115	18	127	1-5 / 7-9	28,40	●		●
VN30.18/20538	115	24	95	1-5 / 7-9	40,00	●		●
VN30.18/20539	115	2x6	2x191	1-5 / 6-7+9-10	9,60 / 10,13	●		●
VN30.18/20540	115	2x7,5	2x153	1-5 / 6-7+9-10	12,40 / 13,00	●		●
VN30.18/20541	115	2x9	2x127	1-5 / 6-7+9-10	14,00 / 14,40	●		●
VN30.18/20542	115	2x12	2x95	1-5 / 6-7+9-10	19,50 / 20,50	●		●
VN30.18/20543	115	2x15	2x76	1-5 / 6-7+9-10	24,20 / 25,50	●		●
VN30.18/20972	115	2x18	2x63	1-5 / 6-7+9-10	27,40 / 28,60	●		●
VN30.18/20973	115	2x24	2x47	1-5 / 6-7+9-10	36,90 / 38,70	●		●

● Trenntransformator / isolation transformer

Typ/Type

EI30/23

Sicherheitstransformator / Kurzschlußfest
VDE 0570 / EN 61558 / ENEC10 geprüft
 Vakuum Epoxydverguss
 Stoßspannungsgeprüft
 Temperaturklasse ta70°C/F
 Cul-Gewicht: 20 g
 Gesamt-Gewicht: 145 g

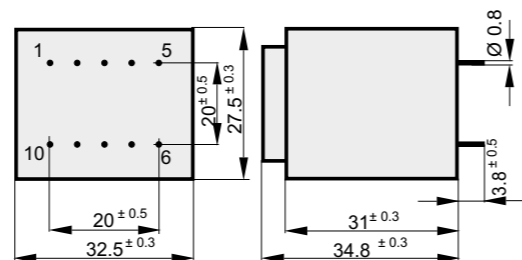

Ansicht auf Stiftseite - Pin view
 Abmessungen in mm - Dimensions in mm

Nennleistung/Nominal power

2.6 VA

Safety transformer / Short-circuit-proof
VDE 0570 / EN 61558 / ENEC10 approved
 Vacuum epoxy casting
 Surge resistance approved
 Temperature class ta70°C/F
 Cul weight: 20 g
 Total weight: 145 g



Bestell Nr. <i>Order No.</i>	Primär [V] <i>Primary</i>	Sekundär [V] <i>Secondary</i>	Strom [mA] <i>Current</i>	Stiftbelegung <i>Pin configuration</i>	Leerlaufspannung [V] <i>No load voltage</i>	Prüfzeichen / Approvals		
						VDE	5085-2/3	5085-1/2

VN30.23/10544	230	6	433	1-5 / 7-9	10,00	●		
VN30.23/10545	230	9	288	1-5 / 7-9	14,40	●		
VN30.23/10546	230	12	216	1-5 / 7-9	20,00	●		
VN30.23/10547	230	15	173	1-5 / 7-9	23,50	●		
VN30.23/10548	230	18	144	1-5 / 7-9	29,10	●		
VN30.23/10549	230	24	108	1-5 / 7-9	36,30	●		
VN30.23/10550	230	2x6	2x216	1-5 / 6-7+9-10	9,80 / 10,20	●		
VN30.23/10551	230	2x7,5	2x173	1-5 / 6-7+9-10	11,50 / 12,00	●		
VN30.23/10552	230	2x9	2x144	1-5 / 6-7+9-10	14,30 / 14,90	●		
VN30.23/10553	230	2x12	2x108	1-5 / 6-7+9-10	19,10 / 19,90	●		
VN30.23/10554	230	2x15	2x86	1-5 / 6-7+9-10	23,40 / 24,30	●		
VN30.23/10974	230	2x18	2x72	1-5 / 6-7+9-10	⊕ 27,60 / 28,40			
VN30.23/10975	230	2x24	2x54	1-5 / 6-7+9-10	⊕ 36,90 / 38,30			

VN30.23/20544	115	6	433	1-5 / 7-9	10,00	●		
VN30.23/20545	115	9	288	1-5 / 7-9	14,40	●		
VN30.23/20546	115	12	216	1-5 / 7-9	20,00	●		
VN30.23/20547	115	15	173	1-5 / 7-9	23,50	●		
VN30.23/20548	115	18	144	1-5 / 7-9	29,10	●		
VN30.23/20549	115	24	108	1-5 / 7-9	36,30	●		
VN30.23/20550	115	2x6	2x216	1-5 / 6-7+9-10	9,80 / 10,20	●		
VN30.23/20551	115	2x7,5	2x173	1-5 / 6-7+9-10	11,50 / 12,00	●		
VN30.23/20552	115	2x9	2x144	1-5 / 6-7+9-10	14,30 / 14,90	●		
VN30.23/20553	115	2x12	2x108	1-5 / 6-7+9-10	19,10 / 19,90	●		
VN30.23/20554	115	2x15	2x86	1-5 / 6-7+9-10	23,40 / 24,30	●		
VN30.23/20974	115	2x18	2x72	1-5 / 6-7+9-10	⊕ 27,60 / 28,40			
VN30.23/20975	115	2x24	2x54	1-5 / 6-7+9-10	⊕ 36,90 / 38,30			

⊕ Trenntransformator / isolation transformer

Typ/Type

EI30/23

Sicherheitstransformator / Kurzschlußfest
VDE 0570 / EN 61558 / ENEC10 geprüft
 Vakuumverguss
 Stoßspannungsgeprüft
 Temperaturklasse ta70°C/F
 Cul-Gewicht: 20 g
 Gesamt-Gewicht: 145 g

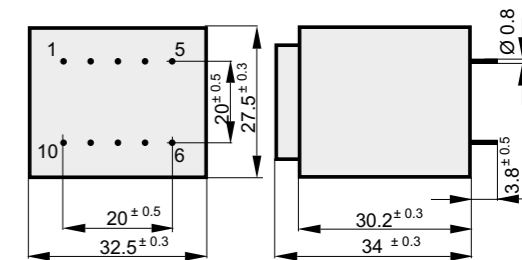

Ansicht auf Stiftseite - Pin view
 Abmessungen in mm - Dimensions in mm

Nennleistung/Nominal power

3.0 VA

Safety transformer / Short-circuit-proof
VDE 0570 / EN 61558 / ENEC10 approved
 Vacuum epoxy casting
 Surge resistance approved
 Temperature class ta70°C/F
 Cul weight: 20 g
 Total weight: 145 g



Bestell Nr. <i>Order No.</i>	Primär [V] <i>Primary</i>	Sekundär [V] <i>Secondary</i>	Strom [mA] <i>Current</i>	Stiftbelegung <i>Pin configuration</i>	Leerlaufspannung [V] <i>No load voltage</i>	Prüfzeichen / Approvals		
						VDE	5085-2/3	5085-1/2

VN30.23/11281	230	6	500	1-5 / 7-9	10,46	●		
VN30.23/11282	230	9	333	1-5 / 7-9	15,86	●		
VN30.23/11283	230	12	250	1-5 / 7-9	20,10	●		
VN30.23/11284	230	15	200	1-5 / 7-9	23,60	●		
VN30.23/11285	230	18	167	1-5 / 7-9	29,15	●		
VN30.23/11286	230	24	125	1-5 / 7-9	38,25	●		
VN30.23/11287	230	2x6	2x250	1-5 / 6-7+9-10	2x10,45	●		
VN30.23/11288	230	2x7,5	2x200	1-5 / 6-7+9-10	2x12,55	●		
VN30.23/11289	230	2x9	2x167	1-5 / 6-7+9-10	2x15,90	●		
VN30.23/11290	230	2x12	2x125	1-5 / 6-7+9-10	2x20,45	●		
VN30.23/11291	230	2x15	2x100	1-5 / 6-7+9-10	2x23,55	●		
VN30.23/11292	230	2x18	2x83,3	1-5 / 6-7+9-10	⊕ 2x29,20			
VN30.23/11293	230	2x24	2x62,5	1-5 / 6-7+9-10	⊕ 2x38,20			

VN30.23/21281	115	6	500	1-5 / 7-9	10,46	●		
VN30.23/21282	115	9	333	1-5 / 7-9	15,86	●		
VN30.23/21283	115	12	250	1-5 / 7-9	20,10	●		
VN30.23/21284	115	15	200	1-5 / 7-9	23,60	●		
VN30.23/21285	115	18	167	1-5 / 7-9	29,15	●		
VN30.23/21286	115	24	125	1-5 / 7-9	38,25	●		
VN30.23/21287	115	2x6	2x250	1-5 / 6-7+9-10	2x10,45	●		
VN30.23/21288	115	2x7,5	2x200	1-5 / 6-7+9-10	2x12,55	●		
VN30.23/21289	115	2x9	2x167	1-5 / 6-7+9-10	2x15,90	●		
VN30.23/21290	115	2x12	2x125	1-5 / 6-7+9-10	2x20,45	●		
VN30.23/21291	115	2x15	2x100	1-5 / 6-7+9-10	2x23,55	●		
VN30.23/21292	115	2x18	2x83,3	1-5 / 6-7+9-10	⊕ 2x29,20			
VN30.23/21293	115	2x24	2x62,5	1-5 / 6-7+9-10	⊕ 2x38,20			

⊕ Trenntransformator / isolation transformer



besonders
geringe
Verlustleistung
Special low
power loss

Eigenschaften unserer EI30-EuP-Transformatoren:

Die Transformatoren dieser Serie wurden speziell für die Strom- und Spannungsversorgung in Geräten entwickelt, bei denen eine reduzierte Leistungsaufnahme gewünscht wird oder die unter die Richtlinie Nr. 1275/2008 fallen. Das Energieeffizienz-Produkte-Gesetz (EBPG) besagt, dass ab dem Jahr 2013 eine Verlustleistung von < 0.5 W im Bereitschafts- und im Auszustand für elektrische und elektronische Büro- und Haushaltsgeräte vorgeschrieben ist.

Vorteile:

- kompakte Bauweise mit einem Leistungsbereich bis 2.8 VA
- minimale Bauhöhe, **geringe Verlustleistung**
- unbedingt kurzschlussfest
- ausgezeichnetes Temperaturwechselverhalten durch Epoxyd-Vakuumverguss
- 100% stückgeprüft mit 4000 V PRI-SEC
- Temperatur-/Isolierstoffklasse ta 40°C/B, ta 70°C/B, **ta 70°C/F**
- höchste Sicherheit und Langlebigkeit
- VDE-, UL-, CSA-, ENEC10-Prüfzeichen
- Zweikammer-Wicklung
- hohe Stoßspannungsfestigkeit
- selbstverlöschendes Haubenmaterial
- optimal für den Einsatz auf Leiterplatten

Characteristics of our EI30-EuP-transformers:

The transformers of this series have been especially developed for power and voltage supply in devices, in which a reduced power input is desired, or to which directive no. 1275/2008 applies. The energy-using products (EuP) law says that starting in 2013, a power loss of < 0.5 W in standby and offline status will be provided for electric and electronic office machines and household appliances.

Advantages:

- compact design with power range up to 2.8 VA
- minimal height, **low power loss**
- inherently short circuit proof
- excellent temperature-change behavior owing to epoxy vacuum casting
- 100% unit checked with 4000 V PRI-SEC
- ambient temperature insulation class ta 40°C/B, ta 70°C/B, **ta 70°C/F**
- highest safety and lifetime
- VDE, UL, CSA, ENEC10 approvals
- split bobbin, two chamber winding
- high surge capability
- self-extinguishing case material
- optimal for PCB mounting

Sämtliche Baugrößen können wir nach Kundenwunsch anpassen:

- weitere PRI-SEC-Spannungen
- individuelle Leistungen
- unvergossene Ausführungen
- spezielle PIN-Belegung
- höhere Temperaturklassen

Customization of all sizes is possible:

- further PRI-SEC voltages
- individual power values
- unpotted versions
- special PIN configurations
- higher temperature classes

Typ Type	Abmessungen (B x T x H) [mm] Dimensions (L x W x H)	Leistung bei ta 70°C/F [VA] Power at ta 70°C/F	Verlustleistung bei ta 70°C/F [W] Losses at ta 70°C/F
EI30/12,5 EuP	32.5 x 27.5 x 24.0	1.2	< 0.4 NEU/NEW
EI30/12,5 EuP	32.5 x 27.5 x 24.0	1.5	< 0.2 NEU/NEW
EI30/15,5 EuP	32.5 x 27.5 x 26.5	1.8	< 0.4 NEU/NEW
EI30/15,5 EuP	32.5 x 27.5 x 26.5	2.0	< 0.2 NEU/NEW
EI30/18 EuP	32.5 x 27.5 x 29.5	2.2	< 0.2 NEU/NEW
EI30/23 EuP	32.5 x 27.5 x 34.0	2.8	< 0.2 NEU/NEW

Typ/Type

EI30/12,5

Sicherheitstransformator / Kurzschlußfest
VDE 0570 / EN 61558 / ENEC10
UL 506 / CSA geprüft
Vakuum Epoxydverguss
Stoßspannungsgeprüft
Temperaturklasse ta70°C/F
Cul-Gewicht: 13 g
Gesamt-Gewicht: 85 g

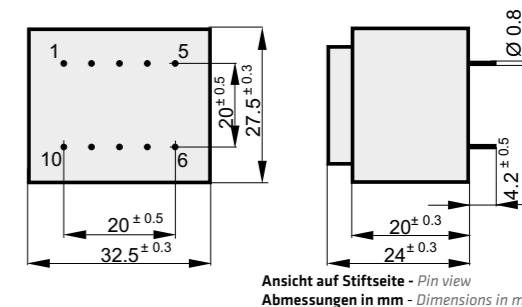

Nennleistung/Nominal power

1.2 VA

Safety transformer / Short-circuit-proof
VDE 0570 / EN 61558 / ENEC10
UL 506 / CSA approved
Vacuum epoxy casting
Surge resistance approved
Temperature class ta70°C/F
Cul weight: 13 g
Total weight: 85 g

Ausführung / version

EuP

Verlustleistung / power loss

< 0.4 W



Bestell Nr. Order No.	Primär [V] Primary	Sekundär [V] Secondary	Strom [mA] Current	Stiftbelegung Pin configuration	Leerlaufspannung [V] No load voltage	Prüfzeichen / Approvals		
						VDE	5085-2/3	5085-1/2
VN30.12/11191	230	6	200	1-5 / 7-9	9,16	●		●
VN30.12/11192	230	9	133	1-5 / 7-9	13,61	●		●
VN30.12/11193	230	12	100	1-5 / 7-9	18,70	●		●
VN30.12/11194	230	15	80	1-5 / 7-9	22,60	●		●
VN30.12/11195	230	18	67	1-5 / 7-9	27,70	●		●
VN30.12/11196	230	24	50	1-5 / 7-9	36,00	●		●
VN30.12/11227	230	2x6	2x100	1-5 / 6-7+9-10	9,00 / 9,30	●		●
VN30.12/11228	230	2x9	2x67	1-5 / 6-7+9-10	13,50 / 14,00	●		●
VN30.12/11229	230	2x12	2x50	1-5 / 6-7+9-10	18,00 / 18,70	●		●
VN30.12/11230	230	2x15	2x40	1-5 / 6-7+9-10	22,50 / 23,40	●		●
VN30.12/11231	230	2x18	2x33	1-5 / 6-7+9-10	27,00 / 28,05	●		●
VN30.12/11232	230	2x24	2x25	1-5 / 6-7+9-10	36,10 / 38,10	●		●

Trenntransformator / isolation transformer

Typ/Type

EI30/12,5

Sicherheitstransformator / Kurzschlußfest
 VDE 0570 / EN 61558 / ENEC10
 UL 506 / CSA geprüft
 Vakuum Epoxydverguss
 Stoßspannungsgeprüft
 Temperaturklasse ta70°C/F
 Cul-Gewicht: 13 g
 Gesamt-Gewicht: 85 g

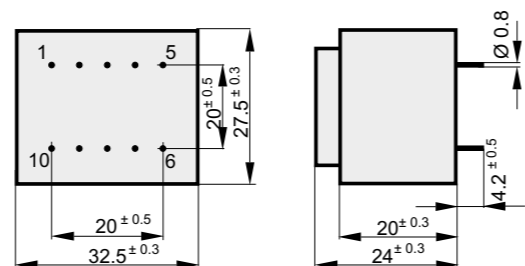

Ansicht auf Stiftseite - Pin view
 Abmessungen in mm - Dimensions in mm

Nennleistung/Nominal power

1.5 VA

Safety transformer / Short-circuit-proof
 VDE 0570 / EN 61558 / ENEC10
 UL 506 / CSA approved
 Vacuum epoxy casting
 Surge resistance approved
 Temperature class ta70°C/F
 Cul weight: 13 g
 Total weight: 85 g

Ausführung / version

EuP

Verlustleistung / power loss

< 0.2 W



Bestell Nr. <i>Order No.</i>	Primär [V] <i>Primary</i>	Sekundär [V] <i>Secondary</i>	Strom [mA] <i>Current</i>	Stiftbelegung <i>Pin configuration</i>	Leerlaufspannung [V] <i>No load voltage</i>	Prüfzeichen / Approvals		
						VDE	5085-2/3	5085-1/2

VN30.12/11197	230	6	250	1-5 / 7-9	9,33	●		●
VN30.12/11198	230	9	167	1-5 / 7-9	13,84	●		●
VN30.12/11199	230	12	125	1-5 / 7-9	19,06	●		●
VN30.12/11200	230	15	100	1-5 / 7-9	22,90	●		●
VN30.12/11201	230	18	83,3	1-5 / 7-9	27,60	●		●
VN30.12/11202	230	24	62,5	1-5 / 7-9	37,60	●		●
VN30.12/11221	230	2x6	2x125	1-5 / 6-7+9-10	9,00 / 9,25	●		●
VN30.12/11222	230	2x9	2x83,3	1-5 / 6-7+9-10	13,28 / 13,85	●		●
VN30.12/11223	230	2x12	2x62,5	1-5 / 6-7+9-10	18,30 / 19,10	●		●
VN30.12/11224	230	2x15	2x50,0	1-5 / 6-7+9-10	23,15 / 24,60	●		●
VN30.12/11225	230	2x18	2x41,7	1-5 / 6-7+9-10	26,84 / 28,46	●		●
VN30.12/11226	230	2x24	2x31,3	1-5 / 6-7+9-10	36,50 / 38,70	●		●

Trenntransformator / isolation transformer

Typ/Type

EI30/15,5

Sicherheitstransformator / Kurzschlußfest
 VDE 0570 / EN 61558 / ENEC10
 UL 506 / CSA geprüft
 Vakuum Epoxydverguss
 Stoßspannungsgeprüft
 Temperaturklasse ta70°C/F
 Cul-Gewicht: 15 g
 Gesamt-Gewicht: 97 g

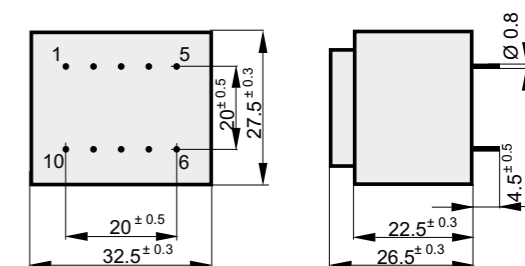

Ansicht auf Stiftseite - Pin view
 Abmessungen in mm - Dimensions in mm

Nennleistung/Nominal power

1.8 VA

Safety transformer / Short-circuit-proof
 VDE 0570 / EN 61558 / ENEC10
 UL 506 / CSA approved
 Vacuum epoxy casting
 Surge resistance approved
 Temperature class ta70°C/F
 Cul weight: 15 g
 Total weight: 97 g

Ausführung / version

EuP

Verlustleistung / power loss

< 0.4 W



Bestell Nr. <i>Order No.</i>	Primär [V] <i>Primary</i>	Sekundär [V] <i>Secondary</i>	Strom [mA] <i>Current</i>	Stiftbelegung <i>Pin configuration</i>	Leerlaufspannung [V] <i>No load voltage</i>	Prüfzeichen / Approvals		
						VDE	5085-2/3	5085-1/2

VN30.15/11209	230	6	300	1-5 / 7-9	10,95	●		●
VN30.15/11210	230	9	200	1-5 / 7-9	16,10	●		●
VN30.15/11211	230	12	150	1-5 / 7-9	21,40	●		●
VN30.15/11212	230	15	120	1-5 / 7-9	26,00	●		●
VN30.15/11213	230	18	100	1-5 / 7-9	32,00	●		●
VN30.15/11214	230	24	75,0	1-5 / 7-9	42,80	●		●
VN30.15/11239	230	2x6	2x150	1-5 / 6-7+9-10	9,75 / 10,10	●		●
VN30.15/11240	230	2x9	2x100	1-5 / 6-7+9-10	14,50 / 15,70	●		●
VN30.15/11241	230	2x12	2x75,0	1-5 / 6-7+9-10	19,00 / 20,50	●		●
VN30.15/11242	230	2x15	2x60,0	1-5 / 6-7+9-10	23,80 / 25,00	●		●
VN30.15/11243	230	2x18	2x50,5	1-5 / 6-7+9-10	28,80 / 30,80	●		●
VN30.15/11244	230	2x24	2x37,5	1-5 / 6-7+9-10	38,60 / 41,20	●		●

Trenntransformator / isolation transformer

Typ/Type

EI30/15,5

Sicherheitstransformator / Kurzschlußfest
 VDE 0570 / EN 61558 / ENEC10
 UL 506 / CSA geprüft
 Vakuum Epoxydverguss
 Stoßspannungsgeprüft
 Temperaturklasse ta70°C/F
 Cul-Gewicht: 15 g
 Gesamt-Gewicht: 97 g

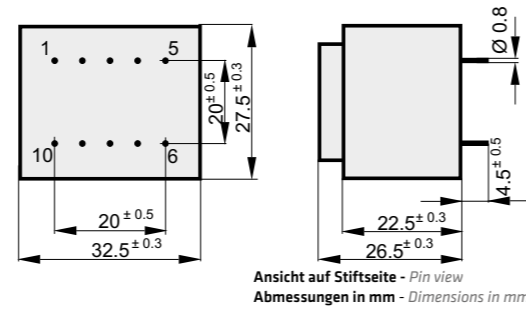

Nennleistung/Nominal power

2.0 VA

Safety transformer / Short-circuit-proof
 VDE 0570 / EN 61558 / ENEC10
 UL 506 / CSA approved
 Vacuum epoxy casting
 Surge resistance approved
 Temperature class ta70°C/F
 Cul weight: 15 g
 Total weight: 97 g

Ausführung / version

EuP

Verlustleistung / power loss

< 0.2 W



Bestell Nr. <i>Order No.</i>	Primär [V] <i>Primary</i>	Sekundär [V] <i>Secondary</i>	Strom [mA] <i>Current</i>	Stiftbelegung <i>Pin configuration</i>	Leerlaufspannung [V] <i>No load voltage</i>	Prüfzeichen / Approvals		
						VDE	5085-2/3	5085-1/2

VN30.15/11203	230	6	333	1-5 / 7-9	10,90	●		●
VN30.15/11204	230	9	222	1-5 / 7-9	16,30	●		●
VN30.15/11205	230	12	167	1-5 / 7-9	21,60	●		●
VN30.15/11206	230	15	133	1-5 / 7-9	26,55	●		●
VN30.15/11207	230	18	111	1-5 / 7-9	32,50	●		●
VN30.15/11208	230	24	83,3	1-5 / 7-9	43,00	●		●
VN30.15/11233	230	2x6	2x167	1-5 / 6-7+9-10	9,85 / 10,20	●		●
VN30.15/11234	230	2x9	2x111	1-5 / 6-7+9-10	14,60 / 15,80	●		●
VN30.15/11235	230	2x12	2x83,3	1-5 / 6-7+9-10	19,20 / 20,70	●		●
VN30.15/11236	230	2x15	2x66,6	1-5 / 6-7+9-10	23,90 / 25,20	●		●
VN30.15/11237	230	2x18	2x55,6	1-5 / 6-7+9-10	29,20 / 31,65	●		●
VN30.15/11238	230	2x24	2x41,7	1-5 / 6-7+9-10	38,75 / 42,00	●		●

Trenntransformator / isolation transformer

Typ/Type

EI30/18

Sicherheitstransformator / Kurzschlußfest
 VDE 0570 / EN 61558 / ENEC10
 UL 506 / CSA geprüft
 Vakuum Epoxydverguss
 Stoßspannungsgeprüft
 Temperaturklasse ta70°C/F
 Cul-Gewicht: 18 g
 Gesamt-Gewicht: 115 g

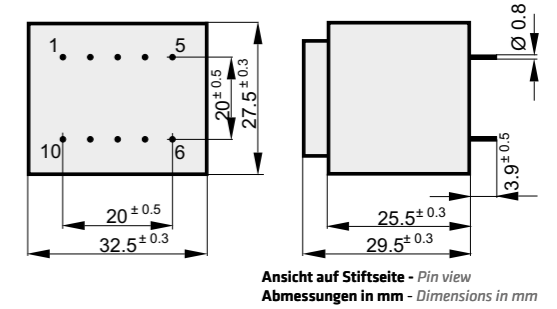

Nennleistung/Nominal power

2.2 VA

Safety transformer / Short-circuit-proof
 VDE 0570 / EN 61558 / ENEC10
 UL 506 / CSA approved
 Vacuum epoxy casting
 Surge resistance approved
 Temperature class ta70°C/F
 Cul weight: 18 g
 Total weight: 115 g

Ausführung / version

EuP

Verlustleistung / power loss

< 0.2 W



Bestell Nr. <i>Order No.</i>	Primär [V] <i>Primary</i>	Sekundär [V] <i>Secondary</i>	Strom [mA] <i>Current</i>	Stiftbelegung <i>Pin configuration</i>	Leerlaufspannung [V] <i>No load voltage</i>	Prüfzeichen / Approvals		
						VDE	5085-2/3	5085-1/2

VN30.18/11338	230	6	367,00	1-5 / 7-9	10,26	●		●
VN30.18/11339	230	9	244,00	1-5 / 7-9	15,50	●		●
VN30.18/11340	230	12	183,30	1-5 / 7-9	20,60	●		●
VN30.18/11341	230	15	146,70	1-5 / 7-9	25,90	●		●
VN30.18/11342	230	18	122,00	1-5 / 7-9	30,80	●		●
VN30.18/11343	230	24	91,70	1-5 / 7-9	41,30	●		●
VN30.18/11344	230	2x6	2x183,00	1-5 / 6-7+9-10	2x10,30	●		●
VN30.18/11345	230	2x9	2x122,00	1-5 / 6-7+9-10	2x15,40	●		●
VN30.18/11346	230	2x12	2x91,70	1-5 / 6-7+9-10	2x20,60	●		●
VN30.18/11347	230	2x15	2x73,30	1-5 / 6-7+9-10	2x24,90	●		●
VN30.18/11348	230	2x18	2x61,00	1-5 / 6-7+9-10	2x30,70	●		●
VN30.18/11349	230	2x24	2x45,80	1-5 / 6-7+9-10	2x40,77	●		●

Trenntransformator / isolation transformer

Typ/Type

EI30/23

Sicherheitstransformator / Kurzschlußfest
 VDE 0570 / EN 61558 / ENEC10
 UL 506 / CSA geprüft
 Vakuum Epoxydverguss
 Stoßspannungsgeprüft
 Temperaturklasse ta70°C/F
 Cul-Gewicht: 20 g
 Gesamt-Gewicht: 145 g

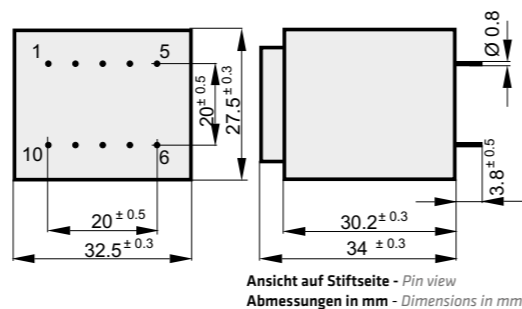

Ansicht auf Stiftseite - Pin view
 Abmessungen in mm - Dimensions in mm

Nennleistung/Nominal power

2.8 VA

Safety transformer / Short-circuit-proof
 VDE 0570 / EN 61558 / ENEC10
 UL 506 / CSA approved
 Vacuum epoxy casting
 Surge resistance approved
 Temperature class ta70°C/F
 Cul weight: 20 g
 Total weight: 145 g

Ausführung / version

EuP

Verlustleistung / power loss

< 0.2 W



Bestell Nr. <i>Order No.</i>	Primär [V] <i>Primary</i>	Sekundär [V] <i>Secondary</i>	Strom [mA] <i>Current</i>	Stiftbelegung <i>Pin configuration</i>	Leerlaufspannung [V] <i>No load voltage</i>	Prüfzeichen / Approvals		
						VDE	5085-2/3	5085-1/2
VN30.23/11362	230	6	467,0	1-5 / 7-9	10,42	●		●
VN30.23/11363	230	9	311,0	1-5 / 7-9	15,68	●		●
VN30.23/11364	230	12	233,0	1-5 / 7-9	20,80	●		●
VN30.23/11365	230	15	187,0	1-5 / 7-9	26,00	●		●
VN30.23/11366	230	18	156,0	1-5 / 7-9	31,25	●		●
VN30.23/11367	230	24	117,0	1-5 / 7-9	41,70	●		●
VN30.23/11368	230	2x6	2x233,0	1-5 / 6-7+9-10	2x10,42	●		●
VN30.23/11369	230	2x9	2x156,0	1-5 / 6-7+9-10	2x15,60	●		●
VN30.23/11370	230	2x12	2x117,0	1-5 / 6-7+9-10	2x20,80	●		●
VN30.23/11371	230	2x15	2x93,0	1-5 / 6-7+9-10	2x24,90	●		●
VN30.23/11372	230	2x18	2x78,0	1-5 / 6-7+9-10	2x31,20	●		●
VN30.23/11373	230	2x24	2x58,0	1-5 / 6-7+9-10	2x41,80	●		●

Trenntransformator / isolation transformer



Entscheidende Vorteile unserer EI38 - EI54-Transformatoren:

- kompakte Bauweise mit einem Leistungsbereich bis 23 VA
- optimale Bauhöhe für den Einsatz auf Leiterplatten
- nicht kurzschlussfest oder bedingt kurzschlussfest mit interner Temperatursicherung
- ausgezeichnetes Temperaturwechselverhalten durch Vakuumverguss
- Absicherung extern durch PTC möglich
- 100% stückgeprüft mit 4000 V PRI-SEC
- Temperatur-/Isolierstoffklasse ta 40°C/B, ta 70°C/B
- höchste Sicherheit und Langlebigkeit
- VDE-, UL-, CSA-, ENEC10-Prüfzeichen
- fester Sitz auf der Leiterplatte durch zusätzliche Befestigungsmöglichkeiten
- Zweikammer-Wicklung
- hohe Stoßspannungsfestigkeit
- selbstverlöschendes Haubenmaterial

Key advantages of our EI38 - EI54-transformers:

- compact design with power range up to 23 VA
- minimal height for installation on PCB boards
- non short circuit proof or conditionally short circuit proof with internal thermal fuse
- excellent temperature-change behavior owing to vacuum casting
- secondary protection by means of external PTC resistances possible
- 100% unit checked with 4000 V PRI-SEC
- ambient temperature insulation class ta 40°C/B, ta 70°C/B
- highest safety and lifetime
- VDE, UL, CSA, ENEC10 approvals
- snug fit on PCB through additional fixing
- split bobbin, two chamber winding
- high surge capability
- self-extinguishing case material

Sämtliche Baugrößen können wir nach Kundenwunsch anpassen:

- weitere PRI-SEC-Spannungen
- individuelle Leistungen
- unvergossene Ausführungen
- spezielle PIN-Belegung
- höhere Temperaturklassen
- eingebaute Thermosicherung/-schalter möglich
- weitere Gehäuse-/Anschluss-/Befestigungsmöglichkeiten
- raumsparende Montage durch innenliegende Befestigungsleiste

Customization of all sizes is possible:

- further PRI-SEC voltages
- individual power values
- unpotted versions
- special PIN configurations
- higher temperature classes
- installed thermal fuse/thermal switch optionally available
- further case/connection/fixing options
- space-saving installation through inside fastening rail

Typ <i>Type</i>	Abmessungen (B x T x H) [mm] <i>Dimensions (L x W x H)</i>	Leistung bei ta 70°C/B [VA] <i>Power at ta 70°C/B</i>
EI38/7,5	41.0 x 34.5 x 22.0	2.5 NEU/NEW
EI38/13,6	41.0 x 34.5 x 27.8	3.2 / 4.5
EI38/16,5	41.0 x 34.5 x 31.0	6.0
EI42/8,5	44.5 x 37.7 x 26.2	3.0 NEU/NEW
EI42/14,8	44.5 x 37.7 x 32.5	5.0 / 6.0
EI42/20,5	44.5 x 37.7 x 38.0	8.0
EI48/16,8	50.5 x 42.5 x 34.7	10.0
EI48/20,5	50.5 x 42.5 x 38.0	12.0
EI48/25,5	50.5 x 42.5 x 43.5	15.0
EI54/14	57.7 x 48.2 x 35.0	12.0 NEU/NEW
EI54/18,8	57.0 x 48.0 x 39.1	16.0
EI54/23	57.7 x 48.2 x 43.2	20.0
EI54/25,5	57.7 x 48.2 x 47.4	23.0 NEU/NEW

Typ/Type

EI38/7,5

Sicherheitstransformator
nach VDE 0570 / EN 61558
Vakuummenguss
Temperaturklasse ta70°C/B
Cul-Gewicht: 20 g
Gesamt-Gewicht: 101 g

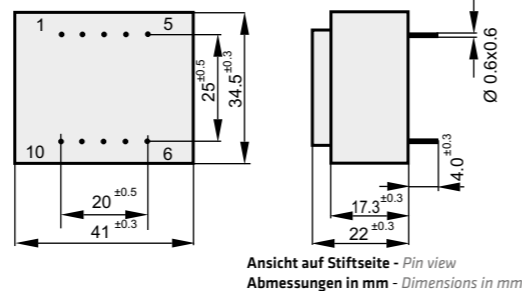

Nennleistung/Nominal power

2.5 VA

Safety transformer
according to VDE 0570 / EN 61558
Vacuum casting
Temperature class ta70°C/B
Cul weight: 20 g
Total weight: 101 g

Ausführung / version

0

Raster / pitch

25 mm



Bestell Nr. <i>Order No.</i>	Primär [V] <i>Primary</i>	Sekundär [V] <i>Secondary</i>	Strom [mA] <i>Current</i>	Stiftbelegung <i>Pin configuration</i>	Leerlaufspannung [V] <i>No load voltage</i>	Prüfzeichen / Approvals		
						VDE	5085-2/3	5085-1/2
VN38.7/13448	230	6	417	1-5 / 7-9	10,30			
VN38.7/13449	230	9	278	1-5 / 7-9	15,40			
VN38.7/13450	230	12	208	1-5 / 7-9	20,00			
VN38.7/13451	230	15	167	1-5 / 7-9	24,80			
VN38.7/13452	230	18	139	1-5 / 7-9	29,90			
VN38.7/13453	230	24	104	1-5 / 7-9	39,10			
VN38.7/13454	230	2x6	2x208	1-5 / 6-7+9-10	2x10,30			
VN38.7/13455	230	2x9	2x139	1-5 / 6-7+9-10	2x15,60			
VN38.7/13456	230	2x12	2x104	1-5 / 6-7+9-10	2x20,50			
VN38.7/13457	230	2x15	2x83	1-5 / 6-7+9-10	2x24,80			
VN38.7/13458	230	2x18	2x69	1-5 / 6-7+9-10	2x29,80			

Trenntransformator / isolation transformer

Typ/Type

EI38/13,6

Sicherheitstransformator
VDE 0570 / EN 61558 / ENEC10
UL 506 / CSA geprüft
Vakuummenguss
Temperaturklasse ta70°C/B
Cul-Gewicht: 25 g
Gesamt-Gewicht: 150 g

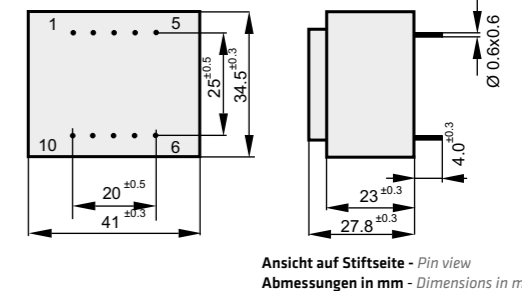

Nennleistung/Nominal power

3.2 VA

Safety transformer
VDE 0570 / EN 61558 / ENEC10
UL 506 / CSA approved
Vacuum casting
Temperature class ta70°C/B
Cul weight: 25 g
Total weight: 150 g

Ausführung / version

0

Raster / pitch

25 mm



Bestell Nr. <i>Order No.</i>	Primär [V] <i>Primary</i>	Sekundär [V] <i>Secondary</i>	Strom [mA] <i>Current</i>	Stiftbelegung <i>Pin configuration</i>	Leerlaufspannung [V] <i>No load voltage</i>	Prüfzeichen / Approvals		
						VDE	5085-2/3	5085-1/2
VN38.13/13135	230	6	533	1-5 / 7-9	7,70	●		●
VN38.13/13201	230	9	355	1-5 / 7-9	11,60	●		●
VN38.13/13202	230	12	266	1-5 / 7-9	15,30	●		●
VN38.13/13203	230	15	213	1-5 / 7-9	19,30	●		●
VN38.13/13204	230	18	177	1-5 / 7-9	23,20	●		●
VN38.13/13205	230	24	133	1-5 / 7-9	31,30	●		●
VN38.13/13136	230	2x6	2x266	1-5 / 6-7+9-10	7,60 / 7,70	●		●
VN38.13/13137	230	2x7,5	2x213	1-5 / 6-7+9-10	9,40 / 9,70	●		●
VN38.13/13141	230	2x9	2x177	1-5 / 6-7+9-10	11,40 / 11,70	●		●
VN38.13/13138	230	2x12	2x133	1-5 / 6-7+9-10	15,40 / 15,70	●		●
VN38.13/13139	230	2x15	2x106	1-5 / 6-7+9-10	19,30 / 19,70	●		●
VN38.13/13253	230	2x18	2x88	1-5 / 6-7+9-10	22,90 / 23,50	●		●
VN38.13/13254	230	2x24	2x66	1-5 / 6-7+9-10	30,40 / 31,00	●		●

Trenntransformator / isolation transformer

Typ/Type

EI38/13,6

Sicherheitstransformator
 VDE 0570 / EN 61558
 ENEC10 / UL 506 / CSA geprüft
 Vakuumverguss
 Temperaturklasse ta70°C/B
 Cul-Gewicht: 25 g
 Gesamt-Gewicht: 150 g

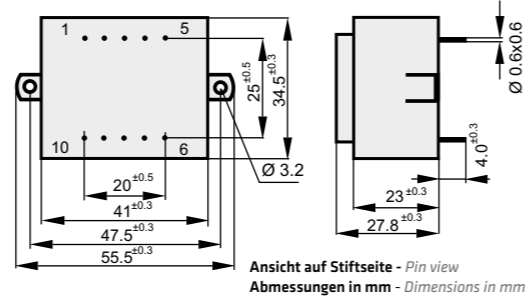

Ausführung / version

K

Raster / pitch

25 mm



Nennleistung/Nominal power

3.2 VA

Safety transformer
 VDE 0570 / EN 61558 / ENEC10
 UL 506 / CSA approved
 Vacuum casting
 Temperature class ta70°C/B
 Cul weight: 25 g
 Total weight: 150 g

Bestell Nr. <i>Order No.</i>	Primär [V] <i>Primary</i>	Sekundär [V] <i>Secondary</i>	Strom [mA] <i>Current</i>	Stiftbelegung <i>Pin configuration</i>	Leerlaufspannung [V] <i>No load voltage</i>	Prüfzeichen / Approvals		
						VDE	5085-2/3	5085-1/2

VN38.13/13344	230	6	533	1-5 / 7-9	7,70	●		●
VN38.13/13345	230	9	355	1-5 / 7-9	11,60	●		●
VN38.13/13346	230	12	266	1-5 / 7-9	15,30	●		●
VN38.13/13347	230	15	213	1-5 / 7-9	19,30	●		●
VN38.13/13348	230	18	177	1-5 / 7-9	23,20	●		●
VN38.13/13349	230	24	133	1-5 / 7-9	31,30	●		●
VN38.13/13350	230	2x6	2x266	1-5 / 6-7+9-10	7,60 / 7,70	●		●
VN38.13/13351	230	2x7,5	2x213	1-5 / 6-7+9-10	9,40 / 9,70	●		●
VN38.13/13352	230	2x9	2x177	1-5 / 6-7+9-10	11,40 / 11,70	●		●
VN38.13/13353	230	2x12	2x133	1-5 / 6-7+9-10	15,40 / 15,70	●		●
VN38.13/13354	230	2x15	2x106	1-5 / 6-7+9-10	19,30 / 19,70	●		●
VN38.13/13355	230	2x18	2x88	1-5 / 6-7+9-10	22,90 / 23,50	●		●
VN38.13/13356	230	2x24	2x66	1-5 / 6-7+9-10	30,40 / 31,00	●		●

VN38.13/23191	115	6	533	1-5 / 7-9	7,70	●		●
VN38.13/23192	115	9	355	1-5 / 7-9	11,60	●		●
VN38.13/23193	115	12	266	1-5 / 7-9	15,30	●		●
VN38.13/23194	115	15	213	1-5 / 7-9	19,30	●		●
VN38.13/23195	115	18	177	1-5 / 7-9	23,20	●		●
VN38.13/23296	115	24	133	1-5 / 7-9	31,30	●		●
VN38.13/23297	115	2x6	2x266	1-5 / 6-7+9-10	7,60 / 7,70	●		●
VN38.13/23298	115	2x7,5	2x213	1-5 / 6-7+9-10	9,40 / 9,70	●		●
VN38.13/23299	115	2x9	2x177	1-5 / 6-7+9-10	11,40 / 11,70	●		●
VN38.13/23300	115	2x12	2x133	1-5 / 6-7+9-10	15,40 / 15,70	●		●
VN38.13/23301	115	2x15	2x106	1-5 / 6-7+9-10	19,30 / 19,70	●		●
VN38.13/23302	115	2x18	2x88	1-5 / 6-7+9-10	22,90 / 23,50	●		●
VN38.13/23303	115	2x24	2x66	1-5 / 6-7+9-10	30,40 / 31,00	●		●

Trenntransformator / isolation transformer

Typ/Type

EI38/13,6

Sicherheitstransformator
 VDE 0570 / EN 61558 / ENEC10
 UL 506 / CSA geprüft
 Vakuumverguss
 Temperaturklasse ta70°C/B
 Cul-Gewicht: 25 g
 Gesamt-Gewicht: 150 g

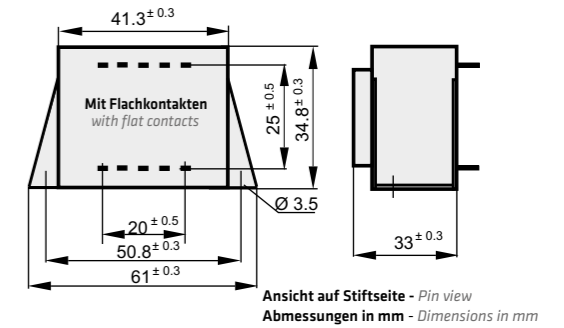

Nennleistung/Nominal power

3.2 VA

Safety transformer
 VDE 0570 / EN 61558 / ENEC10
 UL 506 / CSA approved
 Vacuum casting
 Temperature class ta70°C/B
 Cul weight: 25 g
 Total weight: 150 g

Ausführung / version

VL



Bestell Nr. <i>Order No.</i>	Primär [V] <i>Primary</i>	Sekundär [V] <i>Secondary</i>	Strom [mA] <i>Current</i>	Stiftbelegung <i>Pin configuration</i>	Leerlaufspannung [V] <i>No load voltage</i>	Prüfzeichen / Approvals		
						VDE	5085-2/3	5085-1/2

VN38.13/13357	230	6	533	1-5 / 7-9	7,70	●		●
VN38.13/13358	230	9	355	1-5 / 7-9	11,60	●		●
VN38.13/13359	230	12	266	1-5 / 7-9	15,30	●		●
VN38.13/13360	230	15	213	1-5 / 7-9	19,30	●		●
VN38.13/13361	230	18	177	1-5 / 7-9	23,20	●		●
VN38.13/13362	230	24	133	1-5 / 7-9	31,30	●		●
VN38.13/13363	230	2x6	2x266	1-5 / 6-7+9-10	7,60 / 7,70	●		●
VN38.13/13364	230	2x7,5	2x213	1-5 / 6-7+9-10	9,40 / 9,70	●		●
VN38.13/13365	230	2x9	2x177	1-5 / 6-7+9-10	11,40 / 11,70	●		●
VN38.13/13366	230	2x12	2x133	1-5 / 6-7+9-10	15,40 / 15,70	●		●
VN38.13/13367	230	2x15	2x106	1-5 / 6-7+9-10	19,30 / 19,70	●		●
VN38.13/13368	230	2x18	2x88	1-5 / 6-7+9-10	22,90 / 23,50	●		●
VN38.13/13369	230	2x24	2x66	1-5 / 6-7+9-10	30,40 / 31,00	●		●

VN38.13/23304	115	6	533	1-5 / 7-9	7,70	●		●
VN38.13/23305	115	9	355	1-5 / 7-9	11,60	●		●
VN38.13/23306	115	12	266	1-5 / 7-9	15,30	●		●
VN38.13/23307	115	15	213	1-5 / 7-9	19,30	●		●
VN38.13/23308	115	18	177	1-5 / 7-9	23,20	●		●
VN38.13/23309	115	24	133	1-5 / 7-9	31,30	●		●
VN38.13/23310	115	2x6	2x266	1-5 / 6-7+9-10	7,60 / 7,70	●		●
VN38.13/23311	115	2x7,5	2x213	1-5 / 6-7+9-10	9,40 / 9,70	●		●
VN38.13/23312	115	2x9	2x177	1-5 / 6-7+9-10	11,40 / 11,70	●		●
VN38.13/23313	115	2x12	2x133	1-5 / 6-7+9-10	15,40 / 15,70	●		●
VN38.13/23314	115	2x15	2x106	1-5 / 6-7+9-10	19,30 / 19,70	●		●
VN38.13/23315	115	2x18	2x88	1-5 / 6-7+9-10	22,90 / 23,50	●		●
VN38.13/23316	115	2x24	2x66	1-5 / 6-7+9-10	30,40 / 31,00	●		●

Trenntransformator / isolation transformer

Typ/Type

EI38/13,6

Sicherheitstransformator
 VDE 0570 / EN 61558 / ENEC10
 UL 1585 / CSA geprüft
 Vakuum Epoxydverguss
 Temperaturklasse ta70°C/F
 Cul-Gewicht: 25 g
 Gesamt-Gewicht: 150 g

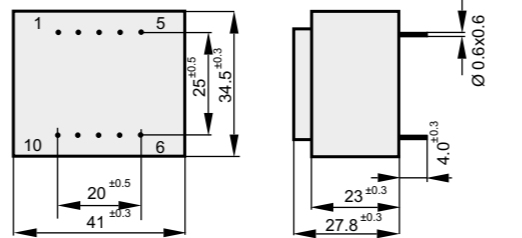

Ansicht auf Stiftseite - Pin view
 Abmessungen in mm - Dimensions in mm

Nennleistung/Nominal power

4.5 VA

Safety transformer
 VDE 0570 / EN 61558 / ENEC10
 UL 1585 / CSA approved
 Vacuum epoxy casting
 Temperature class ta70°C/F
 Cul weight: 25 g
 Total weight: 150 g

Ausführung / version

0

Raster / pitch

25 mm



Bestell Nr. <i>Order No.</i>	Primär [V] <i>Primary</i>	Sekundär [V] <i>Secondary</i>	Strom [mA] <i>Current</i>	Stiftbelegung <i>Pin configuration</i>	Leerlaufspannung [V] <i>No load voltage</i>	Prüfzeichen / Approvals		
						VDE	5085-2/3	5085-1/2

VN38.13/13284	230	6	750	1-5 / 7-9	9,30	●	●	
VN38.13/13285	230	9	500	1-5 / 7-9	12,70	●	●	
VN38.13/13286	230	12	375	1-5 / 7-9	17,40	●	●	
VN38.13/13287	230	15	300	1-5 / 7-9	20,90	●	●	
VN38.13/13288	230	18	250	1-5 / 7-9	24,20	●	●	
VN38.13/13289	230	24	187	1-5 / 7-9	32,60	●	●	
VN38.13/13290	230	2x6	2x375	1-5 / 6-7+9-10	8,90 / 9,30	●	●	
VN38.13/13291	230	2x7,5	2x300	1-5 / 6-7+9-10	10,60 / 11,00	●	●	
VN38.13/13292	230	2x9	2x250	1-5 / 6-7+9-10	12,50 / 13,00	●	●	
VN38.13/13293	230	2x12	2x187	1-5 / 6-7+9-10	17,20 / 17,90	●	●	
VN38.13/13294	230	2x15	2x150	1-5 / 6-7+9-10	20,50 / 21,10	●	●	
VN38.13/13295	230	2x18	2x125	1-5 / 6-7+9-10	24,40 / 24,90	●	●	

VN38.13/23284	115	6	750	1-5 / 7-9	9,30	●	●	
VN38.13/23285	115	9	500	1-5 / 7-9	12,70	●	●	
VN38.13/23286	115	12	375	1-5 / 7-9	17,40	●	●	
VN38.13/23287	115	15	300	1-5 / 7-9	20,90	●	●	
VN38.13/23288	115	18	250	1-5 / 7-9	24,20	●	●	
VN38.13/23289	115	24	187	1-5 / 7-9	32,60	●	●	
VN38.13/23290	115	2x6	2x375	1-5 / 6-7+9-10	8,90 / 9,30	●	●	
VN38.13/23291	115	2x7,5	2x300	1-5 / 6-7+9-10	10,60 / 11,00	●	●	
VN38.13/23292	115	2x9	2x250	1-5 / 6-7+9-10	12,50 / 13,00	●	●	
VN38.13/23293	115	2x12	2x187	1-5 / 6-7+9-10	17,20 / 17,90	●	●	
VN38.13/23294	115	2x15	2x150	1-5 / 6-7+9-10	20,50 / 21,10	●	●	
VN38.13/23295	115	2x18	2x125	1-5 / 6-7+9-10	24,40 / 24,90	●	●	

Typ/Type

EI38/13,6

Sicherheitstransformator
 VDE 0570 / EN 61558 / ENEC10
 UL 1585 / CSA geprüft
 Vakuum Epoxydverguss
 Temperaturklasse ta70°C/F
 Cul-Gewicht: 25 g
 Gesamt-Gewicht: 150 g

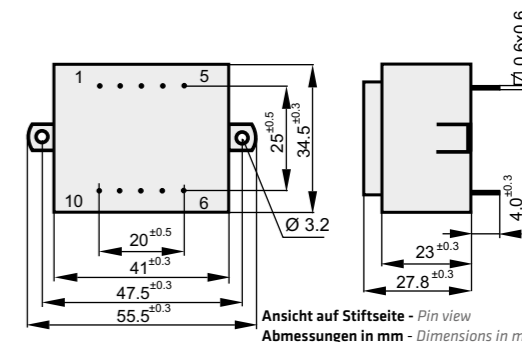

Ansicht auf Stiftseite - Pin view
 Abmessungen in mm - Dimensions in mm

Nennleistung/Nominal power

4.5 VA

Safety transformer
 VDE 0570 / EN 61558 / ENEC10
 UL 1585 / CSA approved
 Vacuum epoxy casting
 Temperature class ta70°C/F
 Cul weight: 25 g
 Total weight: 150 g

Ausführung / version

K

Raster / pitch

25 mm



Bestell Nr. <i>Order No.</i>	Primär [V] <i>Primary</i>	Sekundär [V] <i>Secondary</i>	Strom [mA] <i>Current</i>	Stiftbelegung <i>Pin configuration</i>	Leerlaufspannung [V] <i>No load voltage</i>	Prüfzeichen / Approvals		
						VDE	5085-2/3	5085-1/2

VN38.13/13370	230	6	750	1-5 / 7-9	9,30	●	●	
VN38.13/13371	230	9	500	1-5 / 7-9	12,70	●	●	
VN38.13/13372	230	12	375	1-5 / 7-9	17,40	●	●	
VN38.13/13373	230	15	300	1-5 / 7-9	20,90	●	●	
VN38.13/13374	230	18	250	1-5 / 7-9	24,20	●	●	
VN38.13/13375	230	24	187	1-5 / 7-9	32,60	●	●	
VN38.13/13376	230	2x6	2x375	1-5 / 6-7+9-10	8,90 / 9,30	●	●	
VN38.13/13377	230	2x7,5	2x300	1-5 / 6-7+9-10	10,60 / 11,00	●	●	
VN38.13/13378	230	2x9	2x250	1-5 / 6-7+9-10	12,50 / 13,00	●	●	
VN38.13/13379	230	2x12	2x187	1-5 / 6-7+9-10	17,20 / 17,90	●	●	
VN38.13/13380	230	2x15	2x150	1-5 / 6-7+9-10	20,50 / 21,10	●	●	
VN38.13/13381	230	2x18	2x125	1-5 / 6-7+9-10	24,40 / 24,90	●	●	

VN38.13/23317	115	6	750	1-5 / 7-9	9,30	●	●	
VN38.13/23318	115	9	500	1-5 / 7-9	12,70	●	●	
VN38.13/23319	115	12	375	1-5 / 7-9	17,40	●	●	
VN38.13/23320	115	15	300	1-5 / 7-9	20,90	●	●	
VN38.13/23321	115	18	250	1-5 / 7-9	24,20	●	●	
VN38.13/23322	115	24	187	1-5 / 7-9	32,60	●	●	
VN38.13/23323	115	2x6	2x375	1-5 / 6-7+9-10	8,90 / 9,30	●	●	
VN38.13/23324	115	2x7,5	2x300	1-5 / 6-7+9-10	10,60 / 11,00	●	●	
VN38.13/23325	115	2x9	2x250	1-5 / 6-7+9-10	12,50 / 13,00	●	●	
VN38.13/23326	115	2x12	2x187	1-5 / 6-7+9-10	17,20 / 17,90	●	●	
VN38.13/23327	115	2x15	2x150	1-5 / 6-7+9-10	20,50 / 21,10	●	●	
VN38.13/23328	115	2x18	2x125	1-5 / 6-7+9-10	24,40 / 24,90	●	●	

Typ/Type

EI38/13,6

Sicherheitstransformator
 VDE 0570 / EN 61558 / ENEC10
 UL 1585 / CSA geprüft
 Vakuum Epoxydverguss
 Temperaturklasse ta70°C/F
 Cul-Gewicht: 25 g
 Gesamt-Gewicht: 150 g

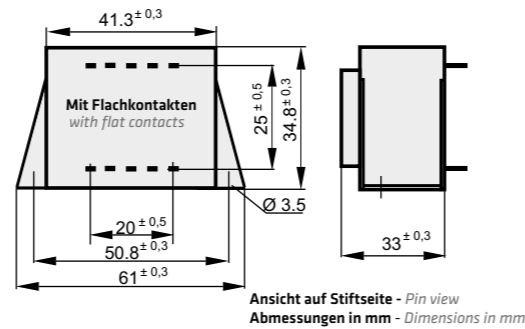

Ausführung / version

VL

Nennleistung/Nominal power

4.5 VA

Safety transformer
 VDE 0570 / EN 61558 / ENEC10
 UL 1585 / CSA approved
 Vacuum epoxy casting
 Temperature class ta70°C/F
 Cul weight: 25 g
 Total weight: 150 g



Bestell Nr. <i>Order No.</i>	Primär [V] <i>Primary</i>	Sekundär [V] <i>Secondary</i>	Strom [mA] <i>Current</i>	Stiftbelegung <i>Pin configuration</i>	Leerlaufspannung [V] <i>No load voltage</i>	Prüfzeichen / Approvals		
						VDE	5085-2/3	5085-1/2
VN38.13/13382	230	6	750	1-5 / 7-9	9,30	●	●	
VN38.13/13383	230	9	500	1-5 / 7-9	12,70	●	●	
VN38.13/13384	230	12	375	1-5 / 7-9	17,40	●	●	
VN38.13/13385	230	15	300	1-5 / 7-9	20,90	●	●	
VN38.13/13386	230	18	250	1-5 / 7-9	24,20	●	●	
VN38.13/13387	230	24	187	1-5 / 7-9	32,60	●	●	
VN38.13/13388	230	2x6	2x375	1-5 / 6-7+9-10	8,90 / 9,30	●	●	
VN38.13/13389	230	2x7,5	2x300	1-5 / 6-7+9-10	10,60 / 11,00	●	●	
VN38.13/13390	230	2x9	2x250	1-5 / 6-7+9-10	12,50 / 13,00	●	●	
VN38.13/13391	230	2x12	2x187	1-5 / 6-7+9-10	17,20 / 17,90	●	●	
VN38.13/13392	230	2x15	2x150	1-5 / 6-7+9-10	20,50 / 21,10	●	●	
VN38.13/13393	230	2x18	2x125	1-5 / 6-7+9-10	24,40 / 24,90	●	●	
VN38.13/23329	115	6	750	1-5 / 7-9	9,30	●	●	
VN38.13/23330	115	9	500	1-5 / 7-9	12,70	●	●	
VN38.13/23331	115	12	375	1-5 / 7-9	17,40	●	●	
VN38.13/23332	115	15	300	1-5 / 7-9	20,90	●	●	
VN38.13/23333	115	18	250	1-5 / 7-9	24,20	●	●	
VN38.13/23334	115	24	187	1-5 / 7-9	32,60	●	●	
VN38.13/23335	115	2x6	2x375	1-5 / 6-7+9-10	8,90 / 9,30	●	●	
VN38.13/23336	115	2x7,5	2x300	1-5 / 6-7+9-10	10,60 / 11,00	●	●	
VN38.13/23337	115	2x9	2x250	1-5 / 6-7+9-10	12,50 / 13,00	●	●	
VN38.13/23338	115	2x12	2x187	1-5 / 6-7+9-10	17,20 / 17,90	●	●	
VN38.13/23339	115	2x15	2x150	1-5 / 6-7+9-10	20,50 / 21,10	●	●	
VN38.13/23340	115	2x18	2x125	1-5 / 6-7+9-10	24,40 / 24,90	●	●	

Typ/Type

EI38/16,5

Sicherheitstransformator
 VDE 0570 / EN 61558 / ENEC10 geprüft
 Vakuumverguss
 Temperaturklasse ta70°C/B
 Cul-Gewicht: 30 g
 Gesamt-Gewicht: 160 g

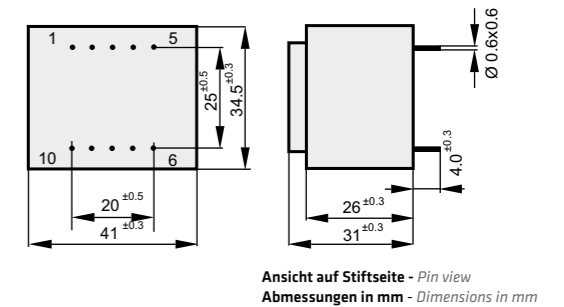

Nennleistung/Nominal power

6.0 VA

Safety transformer
 VDE 0570 / EN 61558 / ENEC10 approved
 Vacuum casting
 Temperature class ta70°C/B
 Cul weight: 30 g
 Total weight: 160 g

Ausführung / version

0

Raster / pitch

25 mm



Bestell Nr. <i>Order No.</i>	Primär [V] <i>Primary</i>	Sekundär [V] <i>Secondary</i>	Strom [mA] <i>Current</i>	Stiftbelegung <i>Pin configuration</i>	Leerlaufspannung [V] <i>No load voltage</i>	Prüfzeichen / Approvals		
						VDE	5085-2/3	5085-1/2
VN38.16/13396	230	9	667	1-5 / 7-9	13,45	●		
VN38.16/13397	230	12	500	1-5 / 7-9	17,40	●		
VN38.16/13398	230	15	400	1-5 / 7-9	21,60	●		
VN38.16/13399	230	18	333	1-5 / 7-9	26,30	●		
VN38.16/13400	230	24	250	1-5 / 7-9	34,50	●		
VN38.16/13401	230	2x9	2x333	1-5 / 6-7+9-10	2x13,30	●		
VN38.16/13402	230	2x12	2x250	1-5 / 6-7+9-10	2x17,50	●		
VN38.16/13403	230	2x15	2x200	1-5 / 6-7+9-10	2x21,45	●		
VN38.16/13404	230	2x18	2x167	1-5 / 6-7+9-10	2x26,15	●		
VN38.16/13405	230	2x24	2x125	1-5 / 6-7+9-10	2x34,80	●		
VN38.16/23396	115	9	667	1-5 / 7-9	13,45	●		
VN38.16/23397	115	12	500	1-5 / 7-9	17,40	●		
VN38.16/23398	115	15	400	1-5 / 7-9	21,60	●		
VN38.16/23399	115	18	333	1-5 / 7-9	26,30	●		
VN38.16/23400	115	24	250	1-5 / 7-9	34,50	●		
VN38.16/23401	115	2x9	2x333	1-5 / 6-7+9-10	2x13,30	●		
VN38.16/23402	115	2x12	2x250	1-5 / 6-7+9-10	2x17,50	●		
VN38.16/23403	115	2x15	2x200	1-5 / 6-7+9-10	2x21,45	●		
VN38.16/23404	115	2x18	2x167	1-5 / 6-7+9-10	2x26,15	●		
VN38.16/23405	115	2x24	2x125	1-5 / 6-7+9-10	2x34,80	●		

Trenntransformator / isolation transformer

Typ/Type

EI42/8,5

Sicherheitstransformator
nach VDE 0570 / EN 61558
Vakuumverguss
Temperaturklasse ta70°C/B
Cul-Gewicht: 25 g
Gesamt-Gewicht: 150 g

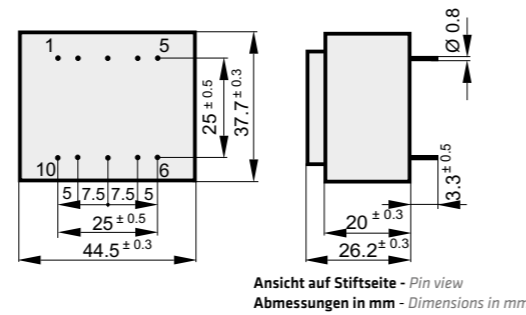

Nennleistung/Nominal power

3.0 VA

Safety transformer
according to VDE 0570 / EN 61558
Vacuum casting
Temperature class ta70°C/B
Cul weight: 25 g
Total weight: 150 g

Ausführung / version

0

Raster / pitch

25 mm

Stifte / pinning

2 x 5



Bestell Nr. <i>Order No.</i>	Primär [V] <i>Primary</i>	Sekundär [V] <i>Secondary</i>	Strom [mA] <i>Current</i>	Stiftbelegung <i>Pin configuration</i>	Leerlaufspannung [V] <i>No load voltage</i>	Prüfzeichen / Approvals		
						VDE	5085-2/3	5085-1/2

VN42.8/15546	230	6	500	1-5 / 7-9	8,90			
VN42.8/15547	230	9	333	1-5 / 7-9	13,20			
VN42.8/15548	230	12	250	1-5 / 7-9	17,00			
VN42.8/15549	230	15	200	1-5 / 7-9	21,35			
VN42.8/15550	230	18	167	1-5 / 7-9	25,70			
VN42.8/15551	230	24	125	1-5 / 7-9	33,80			
VN42.8/15552	230	2x6	2x250	1-5 / 6-7+9-10	2x8,80			
VN42.8/15553	230	2x9	2x167	1-5 / 6-7+9-10	2x13,35			
VN42.8/15554	230	2x12	2x125	1-5 / 6-7+9-10	2x17,20			
VN42.8/15556	230	2x15	2x100	1-5 / 6-7+9-10	2x21,30			
VN42.8/15557	230	2x18	2x83	1-5 / 6-7+9-10	2x24,90			

Typ/Type

EI42/14,8

Sicherheitstransformator
VDE 0570 / EN 61558 / ENEC10
UL 506 / CSA geprüft
Vakuumverguss
Temperaturklasse ta70°C/B
Cul-Gewicht: 30 g
Gesamt-Gewicht: 190 g

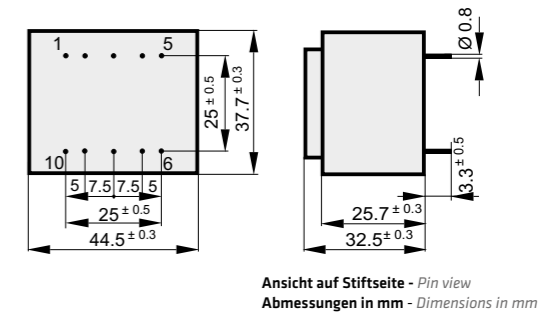

Nennleistung/Nominal power

5.0 VA

Safety transformer
VDE 0570 / EN 61558 / ENEC10
UL 506 / CSA approved
Vacuum casting
Temperature class ta70°C/B
Cul weight: 30 g
Total weight: 190 g

Ausführung / version

0

Raster / pitch

25 mm

Stifte / pinning

2 x 5



Bestell Nr. <i>Order No.</i>	Primär [V] <i>Primary</i>	Sekundär [V] <i>Secondary</i>	Strom [mA] <i>Current</i>	Stiftbelegung <i>Pin configuration</i>	Leerlaufspannung [V] <i>No load voltage</i>	Prüfzeichen / Approvals		
						VDE	5085-2/3	5085-1/2

VN42.14/15300	230	6	833	1-5 / 7-9	7,90	●		●
VN42.14/15301	230	9	555	1-5 / 7-9	11,90	●		●
VN42.14/15302	230	12	416	1-5 / 7-9	15,80	●		●
VN42.14/15303	230	15	333	1-5 / 7-9	19,80	●		●
VN42.14/15304	230	18	277	1-5 / 7-9	24,10	●		●
VN42.14/15305	230	24	208	1-5 / 7-9	31,30	●		●
VN42.14/15306	230	2x6	2x416	1-5 / 6-7+9-10	7,80 / 7,90	●		●
VN42.14/15307	230	2x7,5	2x333	1-5 / 6-7+9-10	9,70 / 9,90	●		●
VN42.14/15308	230	2x9	2x277	1-5 / 6-7+9-10	11,70 / 11,90	●		●
VN42.14/15309	230	2x12	2x208	1-5 / 6-7+9-10	15,40 / 15,70	●		●
VN42.14/15310	230	2x15	2x166	1-5 / 6-7+9-10	19,30 / 19,90	●		●
VN42.14/15311	230	2x18	2x138	1-5 / 6-7+9-10	23,10 / 23,70	●		●
VN42.14/15312	230	2x24	2x104	1-5 / 6-7+9-10	30,60 / 31,20	●		●

VN42.14/25300	115	6	833	1-5 / 7-9	7,90	●		●
VN42.14/25301	115	9	555	1-5 / 7-9	11,90	●		●
VN42.14/25302	115	12	416	1-5 / 7-9	15,80	●		●
VN42.14/25303	115	15	333	1-5 / 7-9	19,80	●		●
VN42.14/25304	115	18	277	1-5 / 7-9	24,10	●		●
VN42.14/25305	115	24	208	1-5 / 7-9	31,30	●		●
VN42.14/25306	115	2x6	2x416	1-5 / 6-7+9-10	7,80 / 7,90	●		●
VN42.14/25307	115	2x7,5	2x333	1-5 / 6-7+9-10	9,70 / 9,90	●		●
VN42.14/25308	115	2x9	2x277	1-5 / 6-7+9-10	11,70 / 11,90	●		●
VN42.14/25309	115	2x12	2x208	1-5 / 6-7+9-10	15,40 / 15,70	●		●
VN42.14/25310	115	2x15	2x166	1-5 / 6-7+9-10	19,30 / 19,90	●		●
VN42.14/25311	115	2x18	2x138	1-5 / 6-7+9-10	23,10 / 23,70	●		●
VN42.14/25312	115	2x24	2x104	1-5 / 6-7+9-10	30,60 / 31,20	●		●

Trenntransformator / isolation transformer

Typ/Type

EI42/14,8

Sicherheitstransformator
 VDE 0570 / EN 61558 / ENEC10
 UL 506 / CSA geprüft
 Vakuumverguss
 Temperaturklasse ta70°C/B
 Cul-Gewicht: 30 g
 Gesamt-Gewicht: 190 g

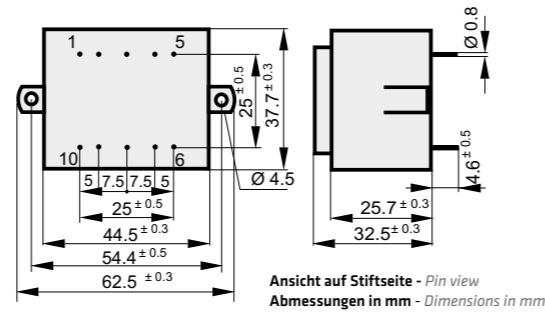

Ausführung / version

K

Raster / pitch

25 mm

Stifte / pinning

2 x 5

Nennleistung/Nominal power

5.0 VA

Safety transformer
 VDE 0570 / EN 61558 / ENEC10
 UL 506 / CSA approved
 Vacuum casting
 Temperature class ta70°C/B
 Cul weight: 30 g
 Total weight: 190 g



Bestell Nr. <i>Order No.</i>	Primär [V] <i>Primary</i>	Sekundär [V] <i>Secondary</i>	Strom [mA] <i>Current</i>	Stiftbelegung <i>Pin configuration</i>	Leerlaufspannung [V] <i>No load voltage</i>	Prüfzeichen / Approvals		
						VDE	5085-2/3	5085-1/2

VN42.14/15387	230	6	833	1-5 / 7-9	7,90	●		●
VN42.14/15388	230	9	555	1-5 / 7-9	11,90	●		●
VN42.14/15389	230	12	416	1-5 / 7-9	15,80	●		●
VN42.14/15390	230	15	333	1-5 / 7-9	19,80	●		●
VN42.14/15391	230	18	277	1-5 / 7-9	24,10	●		●
VN42.14/15392	230	24	208	1-5 / 7-9	31,30	●		●
VN42.14/15393	230	2x6	2x416	1-5 / 6-7+9-10	7,80 / 7,90	●		●
VN42.14/15394	230	2x7,5	2x333	1-5 / 6-7+9-10	9,70 / 9,90	●		●
VN42.14/15395	230	2x9	2x277	1-5 / 6-7+9-10	11,70 / 11,90	●		●
VN42.14/15396	230	2x12	2x208	1-5 / 6-7+9-10	15,40 / 15,70	●		●
VN42.14/15397	230	2x15	2x166	1-5 / 6-7+9-10	19,30 / 19,90	●		●
VN42.14/15398	230	2x18	2x138	1-5 / 6-7+9-10	23,10 / 23,70	●		●
VN42.14/15399	230	2x24	2x104	1-5 / 6-7+9-10	30,60 / 31,20	●		●

VN42.14/25353	115	6	833	1-5 / 7-9	7,90	●		●
VN42.14/25354	115	9	555	1-5 / 7-9	11,90	●		●
VN42.14/25355	115	12	416	1-5 / 7-9	15,80	●		●
VN42.14/25356	115	15	333	1-5 / 7-9	19,80	●		●
VN42.14/25357	115	18	277	1-5 / 7-9	24,10	●		●
VN42.14/25358	115	24	208	1-5 / 7-9	31,30	●		●
VN42.14/25359	115	2x6	2x416	1-5 / 6-7+9-10	7,80 / 7,90	●		●
VN42.14/25360	115	2x7,5	2x333	1-5 / 6-7+9-10	9,70 / 9,90	●		●
VN42.14/25361	115	2x9	2x277	1-5 / 6-7+9-10	11,70 / 11,90	●		●
VN42.14/25362	115	2x12	2x208	1-5 / 6-7+9-10	15,40 / 15,70	●		●
VN42.14/25363	115	2x15	2x166	1-5 / 6-7+9-10	19,30 / 19,90	●		●
VN42.14/25364	115	2x18	2x138	1-5 / 6-7+9-10	23,10 / 23,70	●		●
VN42.14/25365	115	2x24	2x104	1-5 / 6-7+9-10	30,60 / 31,20	●		●

⊕ Trenntransformator / isolation transformer

Typ/Type

EI42/14,8

Sicherheitstransformator
 VDE 0570 / EN 61558 / ENEC10
 UL 506 / CSA geprüft
 Vakuumverguss
 Temperaturklasse ta70°C/B
 Cul-Gewicht: 30 g
 Gesamt-Gewicht: 190 g

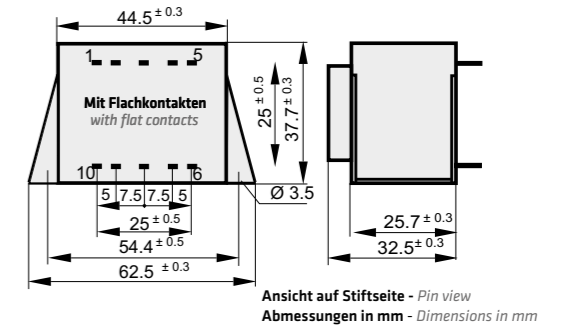

Ausführung / version

VL

Nennleistung/Nominal power

5.0 VA

Safety transformer
 VDE 0570 / EN 61558 / ENEC10
 UL 506 / CSA approved
 Vacuum casting
 Temperature class ta70°C/B
 Cul weight: 30 g
 Total weight: 190 g



Bestell Nr. <i>Order No.</i>	Primär [V] <i>Primary</i>	Sekundär [V] <i>Secondary</i>	Strom [mA] <i>Current</i>	Stiftbelegung <i>Pin configuration</i>	Leerlaufspannung [V] <i>No load voltage</i>	Prüfzeichen / Approvals		
						VDE	5085-2/3	5085-1/2

VN42.14/15400	230	6	833	1-5 / 7-9	7,90	●		●
VN42.14/15401	230	9	555	1-5 / 7-9	11,90	●		●
VN42.14/15402	230	12	416	1-5 / 7-9	15,80	●		●
VN42.14/15403	230	15	333	1-5 / 7-9	19,80	●		●
VN42.14/15404	230	18	277	1-5 / 7-9	24,10	●		●
VN42.14/15405	230	24	208	1-5 / 7-9	31,30	●		●
VN42.14/15406	230	2x6	2x416	1-5 / 6-7+9-10	7,80 / 7,90	●		●
VN42.14/15407	230	2x7,5	2x333	1-5 / 6-7+9-10	9,70 / 9,90	●		●
VN42.14/15408	230	2x9	2x277	1-5 / 6-7+9-10	11,70 / 11,90	●		●
VN42.14/15409	230	2x12	2x208	1-5 / 6-7+9-10	15,40 / 15,70	●		●
VN42.14/15410	230	2x15	2x166	1-5 / 6-7+9-10	19,30 / 19,90	●		●
VN42.14/15411	230	2x18	2x138	1-5 / 6-7+9-10	23,10 / 23,70	●		●
VN42.14/15412	230	2x24	2x104	1-5 / 6-7+9-10	30,60 / 31,20	●		●

VN42.14/25366	115	6	833	1-5 / 7-9	7,90	●		●
VN42.14/25367	115	9	555	1-5 / 7-9	11,90	●		●
VN42.14/25368	115	12	416	1-5 / 7-9	15,80	●		●
VN42.14/25369	115	15	333	1-5 / 7-9	19,80	●		●
VN42.14/25370	115	18	277	1-5 / 7-9	24,10	●		●
VN42.14/25371	115	24	208	1-5 / 7-9	31,30	●		●
VN42.14/25372	115	2x6	2x416	1-5 / 6-7+9-10	7,80 / 7,90	●		●
VN42.14/25373	115	2x7,5	2x333	1-5 / 6-7+9-10	9,70 / 9,90	●		●
VN42.14/25374	115	2x9	2x277	1-5 / 6-7+9-10	11,70 / 11,90	●		●
VN42.14/25375	115	2x12	2x208	1-5 / 6-7+9-10	15,40 / 15,70	●		●
VN42.14/25376	115	2x15	2x166	1-5 / 6-7+9-10	19,30 / 19,90	●		●
VN42.14/25377	115	2x18	2x138	1-5 / 6-7+9-10	23,10 / 23,70	●		●
VN42.14/25378	115	2x24	2x104	1-5 / 6-7+9-10	30,60 / 31,20	●		●

⊕ Trenntransformator / isolation transformer

Typ/Type

EI42/14,8

Sicherheitstransformator
 VDE 0570 / EN 61558 / ENEC10
 UL 506 / CSA geprüft
 Vakuumverguss
 Temperaturklasse ta70°C/B
 Cul-Gewicht: 30 g
 Gesamt-Gewicht: 190 g

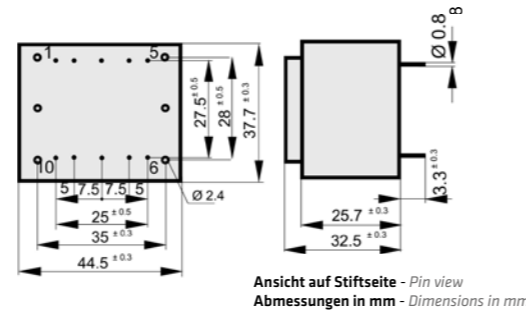

Nennleistung/Nominal power

5.0 VA

Safety transformer
 VDE 0570 / EN 61558 / ENEC10
 UL 506 / CSA approved
 Vacuum casting
 Temperature class ta70°C/B
 Cul weight: 30 g
 Total weight: 190 g

Ausführung / version

B0

Raster / pitch

25 mm

Stifte / pinning

2 x 5



Bestell Nr. <i>Order No.</i>	Primär [V] <i>Primary</i>	Sekundär [V] <i>Secondary</i>	Strom [mA] <i>Current</i>	Stiftbelegung <i>Pin configuration</i>	Leerlaufspannung [V] <i>No load voltage</i>	Prüfzeichen / Approvals		
						VDE	5085-2/3	5085-1/2

VN42.14/15413	230	6	833	1-5 / 7-9	7,90	●		●
VN42.14/15414	230	9	555	1-5 / 7-9	11,90	●		●
VN42.14/15415	230	12	416	1-5 / 7-9	15,80	●		●
VN42.14/15416	230	15	333	1-5 / 7-9	19,80	●		●
VN42.14/15417	230	18	277	1-5 / 7-9	24,10	●		●
VN42.14/15418	230	24	208	1-5 / 7-9	31,30	●		●
VN42.14/15419	230	2x6	2x416	1-5 / 6-7+9-10	7,80 / 7,90	●		●
VN42.14/15420	230	2x7,5	2x333	1-5 / 6-7+9-10	9,70 / 9,90	●		●
VN42.14/15421	230	2x9	2x277	1-5 / 6-7+9-10	11,70 / 11,90	●		●
VN42.14/15422	230	2x12	2x208	1-5 / 6-7+9-10	15,40 / 15,70	●		●
VN42.14/15423	230	2x15	2x166	1-5 / 6-7+9-10	19,30 / 19,90	●		●
VN42.14/15424	230	2x18	2x138	1-5 / 6-7+9-10	23,10 / 23,70	●		●
VN42.14/15425	230	2x24	2x104	1-5 / 6-7+9-10	30,60 / 31,20	●		●

VN42.14/25379	115	6	833	1-5 / 7-9	7,90	●		●
VN42.14/25380	115	9	555	1-5 / 7-9	11,90	●		●
VN42.14/25381	115	12	416	1-5 / 7-9	15,80	●		●
VN42.14/25382	115	15	333	1-5 / 7-9	19,80	●		●
VN42.14/25383	115	18	277	1-5 / 7-9	24,10	●		●
VN42.14/25384	115	24	208	1-5 / 7-9	31,30	●		●
VN42.14/25385	115	2x6	2x416	1-5 / 6-7+9-10	7,80 / 7,90	●		●
VN42.14/25386	115	2x7,5	2x333	1-5 / 6-7+9-10	9,70 / 9,90	●		●
VN42.14/25387	115	2x9	2x277	1-5 / 6-7+9-10	11,70 / 11,90	●		●
VN42.14/25388	115	2x12	2x208	1-5 / 6-7+9-10	15,40 / 15,70	●		●
VN42.14/25389	115	2x15	2x166	1-5 / 6-7+9-10	19,30 / 19,90	●		●
VN42.14/25390	115	2x18	2x138	1-5 / 6-7+9-10	23,10 / 23,70	●		●
VN42.14/25391	115	2x24	2x104	1-5 / 6-7+9-10	30,60 / 31,20	●		●

Trenntransformator / isolation transformer

Typ/Type

EI42/14,8

Sicherheitstransformator
 VDE 0570 / EN 61558
 ENEC10 / UL 506 / CSA geprüft
 Vakuumverguss
 Temperaturklasse ta70°C/B
 Cul-Gewicht: 30 g
 Gesamt-Gewicht: 190 g

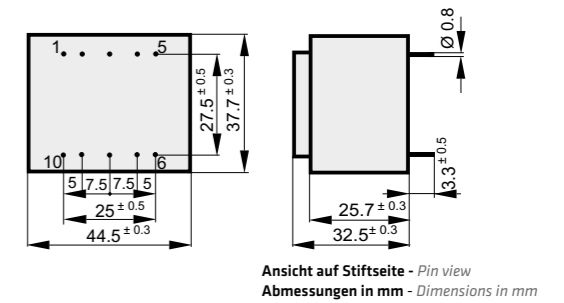

Nennleistung/Nominal power

5.0 VA

Safety transformer
 VDE 0570 / EN 61558 / ENEC10
 UL 506 / CSA approved
 Vacuum casting
 Temperature class ta70°C/B
 Cul weight: 30 g
 Total weight: 190 g

Ausführung / version

0

Raster / pitch

27.5 mm

Stifte / pinning

2 x 5



Bestell Nr. <i>Order No.</i>	Primär [V] <i>Primary</i>	Sekundär [V] <i>Secondary</i>	Strom [mA] <i>Current</i>	Stiftbelegung <i>Pin configuration</i>	Leerlaufspannung [V] <i>No load voltage</i>	Prüfzeichen / Approvals		
						VDE	5085-2/3	5085-1/2

VN42.14/15264	230	6	833	1-5 / 7-9	7,90	●		●
VN42.14/15201	230	9	555	1-5 / 7-9	11,90	●		●
VN42.14/15202	230	12	416	1-5 / 7-9	15,80	●		●
VN42.14/15203	230	15	333	1-5 / 7-9	19,80	●		●
VN42.14/15204	230	18	277	1-5 / 7-9	24,10	●		●
VN42.14/15205	230	24	208	1-5 / 7-9	31,30	●		●
VN42.14/15265	230	2x6	2x416	1-5 / 6-7+9-10	7,80 / 7,90	●		●
VN42.14/15127	230	2x7,5	2x333	1-5 / 6-7+9-10	9,70 / 9,90	●		●
VN42.14/15266	230	2x9	2x277	1-5 / 6-7+9-10	11,70 / 11,90	●		●
VN42.14/15128	230	2x12	2x208	1-5 / 6-7+9-10	15,40 / 15,70	●		●
VN42.14/15267	230	2x15	2x166	1-5 / 6-7+9-10	19,30 / 19,90	●		●
VN42.14/15268	230	2x18	2x138	1-5 / 6-7+9-10	23,10 / 23,70	●		●
VN42.14/15269	230	2x24	2x104	1-5 / 6-7+9-10	30,60 / 31,20	●		●

VN42.14/25264	115	6	833	1-5 / 7-9	7,90	●		●
VN42.14/25201	115	9	555	1-5 / 7-9	11,90	●		●
VN42.14/25202	115	12	416	1-5 / 7-9	15,80	●		●
VN42.14/25203	115	15	333	1-5 / 7-9	19,80	●		●
VN42.14/25204	115	18	277	1-5 / 7-9	24,10	●		●
VN42.14/25205	115	24	208	1-5 / 7-9	31,30	●		●
VN42.14/25265	115	2x6	2x416	1-5 / 6-7+9-10	7,80 / 7,90	●		●
VN42.14/25127	115	2x7,5	2x333	1-5 / 6-7+9-10	9,70 / 9,90	●		●
VN42.14/25266	115	2x9	2x277	1-5 / 6-7+9-10	11,70 / 11,90	●		●
VN42.14/25128	115	2x12	2x208	1-5 / 6-7+9-10	15,40 / 15,70	●		●
VN42.14/25267	115	2x15	2x166	1-5 / 6-7+9-10	19,30 / 19,90	●		●
VN42.14/25268	115	2x18	2x138	1-5 / 6-7+9-10	23,10 / 23,70	●		●
VN42.14/25269	115	2x24	2x104	1-5 / 6-7+9-10	30,60 / 31,20	●		●

Trenntransformator / isolation transformer

Typ/Type

EI42/14,8

Sicherheitstransformator
 VDE 0570 / EN 61558 / ENEC10
 UL 506 / CSA geprüft
 Vakuumverguss
 Temperaturklasse ta70°C/B
 Cul-Gewicht: 30 g
 Gesamt-Gewicht: 190 g

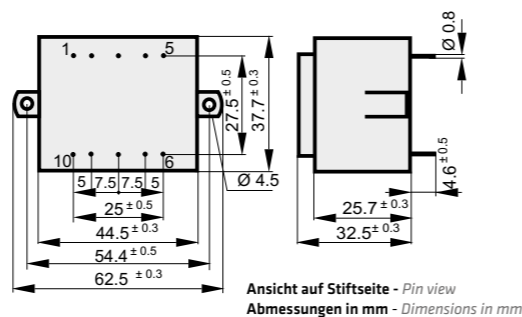

Nennleistung/Nominal power

5.0 VA

Safety transformer
 VDE 0570 / EN 61558 / ENEC10
 UL 506 / CSA approved
 Vacuum casting
 Temperature class ta70°C/B
 Cul weight: 30 g
 Total weight: 190 g

Ausführung / version

K

Raster / pitch

27.5 mm 2 x 5

Stifte / pinning



Bestell Nr. <i>Order No.</i>	Primär [V] <i>Primary</i>	Sekundär [V] <i>Secondary</i>	Strom [mA] <i>Current</i>	Stiftbelegung <i>Pin configuration</i>	Leerlaufspannung [V] <i>No load voltage</i>	Prüfzeichen / Approvals		
						VDE	5085-2/3	5085-1/2

VN42.14/15348	230	6	833	1-5 / 7-9	7,90	●		●
VN42.14/15349	230	9	555	1-5 / 7-9	11,90	●		●
VN42.14/15350	230	12	416	1-5 / 7-9	15,80	●		●
VN42.14/15351	230	15	333	1-5 / 7-9	19,80	●		●
VN42.14/15352	230	18	277	1-5 / 7-9	24,10	●		●
VN42.14/15353	230	24	208	1-5 / 7-9	31,30	●		●
VN42.14/15354	230	2x6	2x416	1-5 / 6-7+9-10	7,80 / 7,90	●		●
VN42.14/15355	230	2x7,5	2x333	1-5 / 6-7+9-10	9,70 / 9,90	●		●
VN42.14/15356	230	2x9	2x277	1-5 / 6-7+9-10	11,70 / 11,90	●		●
VN42.14/15357	230	2x12	2x208	1-5 / 6-7+9-10	15,40 / 15,70	●		●
VN42.14/15358	230	2x15	2x166	1-5 / 6-7+9-10	19,30 / 19,90	●		●
VN42.14/15359	230	2x18	2x138	1-5 / 6-7+9-10	23,10 / 23,70	●		●
VN42.14/15360	230	2x24	2x104	1-5 / 6-7+9-10	30,60 / 31,20	●		●

VN42.14/25313	115	6	833	1-5 / 7-9	7,90	●		●
VN42.14/25314	115	9	555	1-5 / 7-9	11,90	●		●
VN42.14/25315	115	12	416	1-5 / 7-9	15,80	●		●
VN42.14/25316	115	15	333	1-5 / 7-9	19,80	●		●
VN42.14/25317	115	18	277	1-5 / 7-9	24,10	●		●
VN42.14/25318	115	24	208	1-5 / 7-9	31,30	●		●
VN42.14/25319	115	2x6	2x416	1-5 / 6-7+9-10	7,80 / 7,90	●		●
VN42.14/25320	115	2x7,5	2x333	1-5 / 6-7+9-10	9,70 / 9,90	●		●
VN42.14/25321	115	2x9	2x277	1-5 / 6-7+9-10	11,70 / 11,90	●		●
VN42.14/25322	115	2x12	2x208	1-5 / 6-7+9-10	15,40 / 15,70	●		●
VN42.14/25323	115	2x15	2x166	1-5 / 6-7+9-10	19,30 / 19,90	●		●
VN42.14/25324	115	2x18	2x138	1-5 / 6-7+9-10	23,10 / 23,70	●		●
VN42.14/25325	115	2x24	2x104	1-5 / 6-7+9-10	30,60 / 31,20	●		●

Trenntransformator / isolation transformer

Typ/Type

EI42/14,8

Sicherheitstransformator
 VDE 0570 / EN 61558 / ENEC10
 UL 506 / CSA geprüft
 Vakuumverguss
 Temperaturklasse ta70°C/B
 Cul-Gewicht: 30 g
 Gesamt-Gewicht: 190 g

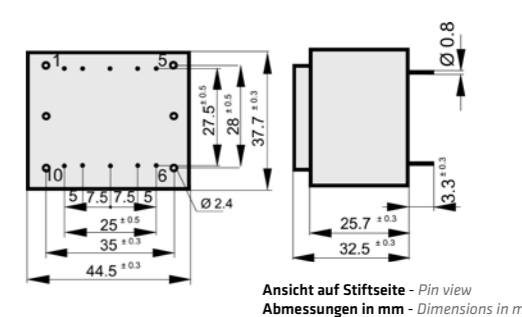

Nennleistung/Nominal power

5.0 VA

Safety transformer
 VDE 0570 / EN 61558 / ENEC10
 UL 506 / CSA approved
 Vacuum casting
 Temperature class ta70°C/B
 Cul weight: 30 g
 Total weight: 190 g

Ausführung / version

B0

Raster / pitch

27.5 mm 2 x 5

Stifte / pinning



Bestell Nr. <i>Order No.</i>	Primär [V] <i>Primary</i>	Sekundär [V] <i>Secondary</i>	Strom [mA] <i>Current</i>	Stiftbelegung <i>Pin configuration</i>	Leerlaufspannung [V] <i>No load voltage</i>	Prüfzeichen / Approvals		
						VDE	5085-2/3	5085-1/2

VN42.14/15491	230	6	833	1-5 / 7-9	7,90	●		●
VN42.14/15492	230	9	555	1-5 / 7-9	11,90	●		●
VN42.14/15493	230	12	416	1-5 / 7-9	15,80	●		●
VN42.14/15494	230	15	333	1-5 / 7-9	19,80	●		●
VN42.14/15495	230	18	277	1-5 / 7-9	24,10	●		●
VN42.14/15496	230	24	208	1-5 / 7-9	31,20	●		●
VN42.14/15497	230	2x6	2x416	1-5 / 6-7+9-10	7,80 / 7,90	●		●
VN42.14/15498	230	2x7,5	2x333	1-5 / 6-7+9-10	9,70 / 9,90	●		●
VN42.14/15499	230	2x9	2x277	1-5 / 6-7+9-10	11,70 / 11,90	●		●
VN42.14/15500	230	2x12	2x208	1-5 / 6-7+9-10	15,40 / 15,70	●		●
VN42.14/15501	230	2x15	2x166	1-5 / 6-7+9-10	19,30 / 19,90	●		●
VN42.14/15502	230	2x18	2x138	1-5 / 6-7+9-10	23,10 / 23,70	●		●
VN42.14/15503	230	2x24	2x104	1-5 / 6-7+9-10	30,60 / 31,20	●		●

VN42.14/25457	115	6	833	1-5 / 7-9	7,90	●		●
VN42.14/25458	115	9	555	1-5 / 7-9	11,90	●		●
VN42.14/25459	115	12	416	1-5 / 7-9	15,80	●		●
VN42.14/25460	115	15	333	1-5 / 7-9	19,80	●		●
VN42.14/25461	115	18	277	1-5 / 7-9	24,10	●		●
VN42.14/25462	115	24	208	1-5 / 7-9	31,20	●		●
VN42.14/25463	115	2x6	2x416	1-5 / 6-7+9-10	7,80 / 7,90	●		●
VN42.14/25464	115	2x7,5	2x333	1-5 / 6-7+9-10	9,70 / 9,90	●		●
VN42.14/25465	115	2x9	2x277	1-5 / 6-7+9-10	11,70 / 11,90	●		●
VN42.14/25466	115	2x12	2x208	1-5 / 6-7+9-10	15,40 / 15,70	●		●
VN42.14/25467	115	2x15	2x166	1-5 / 6-7+9-10	19,30 / 19,90	●		●
VN42.14/25468	115	2x18	2x138	1-5 / 6-7+9-10	23,10 / 23,70	●		●
VN42.14/25469	115	2x24	2x104	1-5 / 6-7+9-10	30,60 / 31,20	●		●

Trenntransformator / isolation transformer

Typ/Type

EI42/14,8

Sicherheitstransformator
 VDE 0570 / EN 61558 / ENEC10 geprüft
 Vakuumverguss
 Temperaturklasse ta70°C/B
 Cul-Gewicht: 30 g
 Gesamt-Gewicht: 190 g

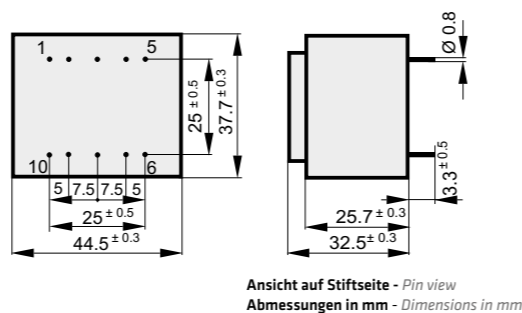

Nennleistung/Nominal power

6.0 VA

Safety transformer
 VDE 0570 / EN 61558 / ENEC10 approved
 Vacuum casting
 Temperature class ta70°C/B
 Cul weight: 30 g
 Total weight: 190 g

Ausführung / version

0

Raster / pitch

25 mm

Stifte / pinning

2 x 5



Bestell Nr. <i>Order No.</i>	Primär [V] <i>Primary</i>	Sekundär [V] <i>Secondary</i>	Strom [mA] <i>Current</i>	Stiftbelegung <i>Pin configuration</i>	Leerlaufspannung [V] <i>No load voltage</i>	Prüfzeichen / Approvals		
						VDE	5085-2/3	5085-1/2

VN42.14/15506	230	6	1000	1-5 / 7-9	8,75	●		
VN42.14/15507	230	9	667	1-5 / 7-9	13,30	●		
VN42.14/15508	230	12	500	1-5 / 7-9	16,85	●		
VN42.14/15509	230	15	400	1-5 / 7-9	20,60	●		
VN42.14/15510	230	18	333	1-5 / 7-9	24,55	●		
VN42.14/15511	230	24	250	1-5 / 7-9	30,50	●		
VN42.14/15512	230	2x6	2x500	1-5 / 6-7+9-10	2x8,70	●		
VN42.14/15513	230	2x7,5	2x400	1-5 / 6-7+9-10	2x11,00	●		
VN42.14/15514	230	2x9	2x333	1-5 / 6-7+9-10	2x13,40	●		
VN42.14/15515	230	2x12	2x250	1-5 / 6-7+9-10	2x16,80	●		
VN42.14/15516	230	2x15	2x200	1-5 / 6-7+9-10	2x20,75	●		
VN42.14/15517	230	2x18	2x167	1-5 / 6-7+9-10	2x24,70	●		
VN42.14/15518	230	2x24	2x125	1-5 / 6-7+9-10	2x30,70	●		

VN42.14/25506	115	6	1000	1-5 / 7-9	8,75	●		
VN42.14/25507	115	9	667	1-5 / 7-9	13,30	●		
VN42.14/25508	115	12	500	1-5 / 7-9	16,85	●		
VN42.14/25509	115	15	400	1-5 / 7-9	20,60	●		
VN42.14/25510	115	18	333	1-5 / 7-9	24,55	●		
VN42.14/25511	115	24	250	1-5 / 7-9	30,50	●		
VN42.14/25512	115	2x6	2x500	1-5 / 6-7+9-10	2x8,70	●		
VN42.14/25513	115	2x7,5	2x400	1-5 / 6-7+9-10	2x11,00	●		
VN42.14/25514	115	2x9	2x333	1-5 / 6-7+9-10	2x13,40	●		
VN42.14/25515	115	2x12	2x250	1-5 / 6-7+9-10	2x16,80	●		
VN42.14/25516	115	2x15	2x200	1-5 / 6-7+9-10	2x20,75	●		
VN42.14/25517	115	2x18	2x167	1-5 / 6-7+9-10	2x24,70	●		
VN42.14/25518	115	2x24	2x125	1-5 / 6-7+9-10	2x30,70	●		

Trenntransformator / isolation transformer

Typ/Type

EI42/14,8

Sicherheitstransformator
 VDE 0570 / EN 61558 / ENEC10 geprüft
 Vakuumverguss
 Temperaturklasse ta70°C/B
 Cul-Gewicht: 30 g
 Gesamt-Gewicht: 190 g

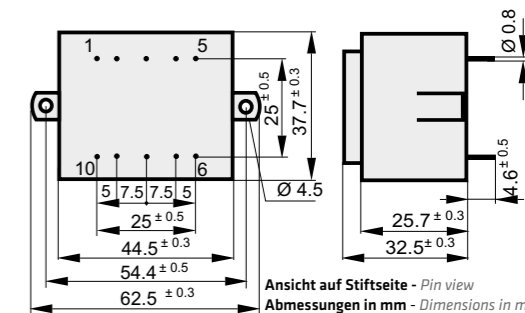

Nennleistung/Nominal power

6.0 VA

Safety transformer
 VDE 0570 / EN 61558 / ENEC10 approved
 Vacuum casting
 Temperature class ta70°C/B
 Cul weight: 30 g
 Total weight: 190 g

Ausführung / version

K

Raster / pitch

25 mm

Stifte / pinning

2 x 5



Bestell Nr. <i>Order No.</i>	Primär [V] <i>Primary</i>	Sekundär [V] <i>Secondary</i>	Strom [mA] <i>Current</i>	Stiftbelegung <i>Pin configuration</i>	Leerlaufspannung [V] <i>No load voltage</i>	Prüfzeichen / Approvals		
						VDE	5085-2/3	5085-1/2

VN42.14/15426	230	6	1000	1-5 / 7-9	8,75	●		
VN42.14/15427	230	9	667	1-5 / 7-9	13,30	●		
VN42.14/15428	230	12	500	1-5 / 7-9	16,85	●		
VN42.14/15429	230	15	400	1-5 / 7-9	20,60	●		
VN42.14/15430	230	18	333	1-5 / 7-9	24,55	●		
VN42.14/15431	230	24	250	1-5 / 7-9	30,50	●		
VN42.14/15432	230	2x6	2x500	1-5 / 6-7+9-10	2x8,70	●		
VN42.14/15433	230	2x7,5	2x400	1-5 / 6-7+9-10	2x11,00	●		
VN42.14/15434	230	2x9	2x333	1-5 / 6-7+9-10	2x13,40	●		
VN42.14/15435	230	2x12	2x250	1-5 / 6-7+9-10	2x16,80	●		
VN42.14/15436	230	2x15	2x200	1-5 / 6-7+9-10	2x20,75	●		
VN42.14/15437	230	2x18	2x167	1-5 / 6-7+9-10	2x24,70	●		
VN42.14/15438	230	2x24	2x125	1-5 / 6-7+9-10	2x30,70	●		

VN42.14/25392	115	6	1000	1-5 / 7-9	8,75	●		
VN42.14/25393	115	9	667	1-5 / 7-9	13,30	●		
VN42.14/25394	115	12	500	1-5 / 7-9	16,85	●		
VN42.14/25395	115	15	400	1-5 / 7-9	20,60	●		
VN42.14/25396	115	18	333	1-5 / 7-9	24,55	●		
VN42.14/25397	115	24	250	1-5 / 7-9	30,50	●		
VN42.14/25398	115	2x6	2x500	1-5 / 6-7+9-10	2x8,70	●		
VN42.14/25399	115	2x7,5	2x400	1-5 / 6-7+9-10	2x11,00	●		
VN42.14/25400	115	2x9	2x333	1-5 / 6-7+9-10	2x13,40	●		
VN42.14/25401	115	2x12	2x250	1-5 / 6-7+9-10	2x16,80	●		
VN42.14/25402	115	2x15	2x200	1-5 / 6-7+9-10	2x20,75	●		
VN42.14/25403	115	2x18	2x167	1-5 / 6-7+9-10	2x24,70	●		
VN42.14/25404	115	2x24	2x125	1-5 / 6-7+9-10	2x30,70	●		

Trenntransformator / isolation transformer

Typ/Type

EI42/14,8

Sicherheitstransformator
VDE 0570 / EN 61558 / ENEC10 geprüft
Vakuumverguss
Temperaturklasse ta70°C/B
Cul-Gewicht: 30 g
Gesamt-Gewicht: 190 g

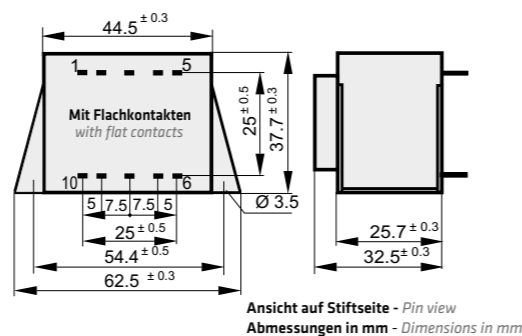

Ansicht auf Stiftseite - Pin view
Abmessungen in mm - Dimensions in mm

Ausführung / version

VL

Nennleistung/Nominal power

6.0 VA

Safety transformer
VDE 0570 / EN 61558 / ENEC10 approved
Vacuum casting
Temperature class ta70°C/B
Cul weight: 30 g
Total weight: 190 g



Bestell Nr. <i>Order No.</i>	Primär [V] <i>Primary</i>	Sekundär [V] <i>Secondary</i>	Strom [mA] <i>Current</i>	Stiftbelegung <i>Pin configuration</i>	Leerlaufspannung [V] <i>No load voltage</i>	Prüfzeichen / Approvals		
						VDE	5085-2/3	5085-1/2

VN42.14/15439	230	6	1000	1-5 / 7-9	8,75	●		
VN42.14/15440	230	9	667	1-5 / 7-9	13,30	●		
VN42.14/15441	230	12	500	1-5 / 7-9	16,85	●		
VN42.14/15442	230	15	400	1-5 / 7-9	20,60	●		
VN42.14/15443	230	18	333	1-5 / 7-9	24,55	●		
VN42.14/15444	230	24	250	1-5 / 7-9	30,50	●		
VN42.14/15445	230	2x6	2x500	1-5 / 6-7+9-10	2x8,70	●		
VN42.14/15446	230	2x7,5	2x400	1-5 / 6-7+9-10	2x11,00	●		
VN42.14/15447	230	2x9	2x333	1-5 / 6-7+9-10	2x13,40	●		
VN42.14/15448	230	2x12	2x250	1-5 / 6-7+9-10	2x16,80	●		
VN42.14/15449	230	2x15	2x200	1-5 / 6-7+9-10	2x20,75	●		
VN42.14/15450	230	2x18	2x167	1-5 / 6-7+9-10	2x24,70	●		
VN42.14/15451	230	2x24	2x125	1-5 / 6-7+9-10	2x30,70	●		

VN42.14/25405	115	6	1000	1-5 / 7-9	8,75	●		
VN42.14/25406	115	9	667	1-5 / 7-9	13,30	●		
VN42.14/25407	115	12	500	1-5 / 7-9	16,85	●		
VN42.14/25408	115	15	400	1-5 / 7-9	20,60	●		
VN42.14/25409	115	18	333	1-5 / 7-9	24,55	●		
VN42.14/25410	115	24	250	1-5 / 7-9	30,50	●		
VN42.14/25411	115	2x6	2x500	1-5 / 6-7+9-10	2x8,70	●		
VN42.14/25412	115	2x7,5	2x400	1-5 / 6-7+9-10	2x11,00	●		
VN42.14/25413	115	2x9	2x333	1-5 / 6-7+9-10	2x13,40	●		
VN42.14/25414	115	2x12	2x250	1-5 / 6-7+9-10	2x16,80	●		
VN42.14/25415	115	2x15	2x200	1-5 / 6-7+9-10	2x20,75	●		
VN42.14/25416	115	2x18	2x167	1-5 / 6-7+9-10	2x24,70	●		
VN42.14/25417	115	2x24	2x125	1-5 / 6-7+9-10	2x30,70	●		

Trenntransformator / isolation transformer

Typ/Type

EI42/14,8

Sicherheitstransformator
VDE 0570 / EN 61558 / ENEC10 geprüft
Vakuumverguss
Temperaturklasse ta70°C/B
Cul-Gewicht: 30 g
Gesamt-Gewicht: 190 g

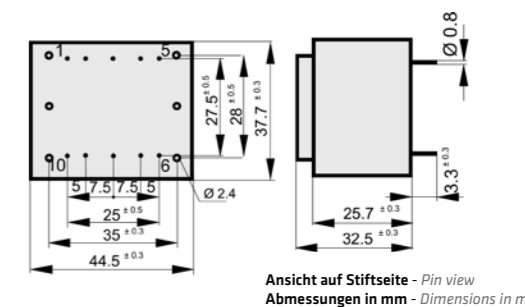

Ansicht auf Stiftseite - Pin view
Abmessungen in mm - Dimensions in mm

Nennleistung/Nominal power

6.0 VA

Safety transformer
VDE 0570 / EN 61558 / ENEC10 approved
Vacuum casting
Temperature class ta70°C/B
Cul weight: 30 g
Total weight: 190 g

Ausführung / version

B0

Raster / pitch

25 mm

Stifte / pinning

2 x 5



Bestell Nr. <i>Order No.</i>	Primär [V] <i>Primary</i>	Sekundär [V] <i>Secondary</i>	Strom [mA] <i>Current</i>	Stiftbelegung <i>Pin configuration</i>	Leerlaufspannung [V] <i>No load voltage</i>	Prüfzeichen / Approvals		
						VDE	5085-2/3	5085-1/2

VN42.14/15452	230	6	1000	1-5 / 7-9	8,75	●		
VN42.14/15453	230	9	667	1-5 / 7-9	13,30	●		
VN42.14/15454	230	12	500	1-5 / 7-9	16,85	●		
VN42.14/15455	230	15	400	1-5 / 7-9	20,60	●		
VN42.14/15456	230	18	333	1-5 / 7-9	24,55	●		
VN42.14/15457	230	24	250	1-5 / 7-9	30,50	●		
VN42.14/15458	230	2x6	2x500	1-5 / 6-7+9-10	2x8,70	●		
VN42.14/15459	230	2x7,5	2x400	1-5 / 6-7+9-10	2x11,00	●		
VN42.14/15460	230	2x9	2x333	1-5 / 6-7+9-10	2x13,40	●		
VN42.14/15461	230	2x12	2x250	1-5 / 6-7+9-10	2x16,80	●		
VN42.14/15462	230	2x15	2x200	1-5 / 6-7+9-10	2x20,75	●		
VN42.14/15463	230	2x18	2x167	1-5 / 6-7+9-10	2x24,70	●		
VN42.14/15464	230	2x24	2x125	1-5 / 6-7+9-10	2x30,70	●		

VN42.14/25418	115	6	1000	1-5 / 7-9	8,75	●		
VN42.14/25419	115	9	667	1-5 / 7-9	13,30	●		
VN42.14/25420	115	12	500	1-5 / 7-9	16,85	●		
VN42.14/25421	115	15	400	1-5 / 7-9	20,60	●		
VN42.14/25422	115	18	333	1-5 / 7-9	24,55	●		
VN42.14/25423	115	24	250	1-5 / 7-9	30,50	●		
VN42.14/25424	115	2x6	2x500	1-5 / 6-7+9-10	2x8,70	●		
VN42.14/25425	115	2x7,5	2x400	1-5 / 6-7+9-10	2x11,00	●		
VN42.14/25426	115	2x9	2x333	1-5 / 6-7+9-10	2x13,40	●		
VN42.14/25427	115	2x12	2x250	1-5 / 6-7+9-10	2x16,80	●		
VN42.14/25428	115	2x15	2x200	1-5 / 6-7+9-10	2x20,75	●		
VN42.14/25429	115	2x18	2x167	1-5 / 6-7+9-10	2x24,70	●		
VN42.14/25430	115	2x24	2x125	1-5 / 6-7+9-10	2x30,70	●		

Trenntransformator / isolation transformer

Typ/Type

EI42/14,8

Sicherheitstransformator
 VDE 0570 / EN 61558 / ENEC10 geprüft
 Vakuumverguss
 Temperaturklasse ta70°C/B
 Cul-Gewicht: 30 g
 Gesamt-Gewicht: 190 g

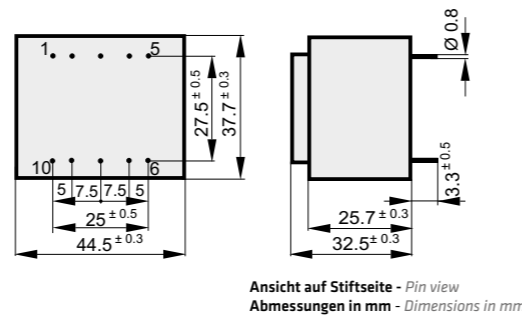

Nennleistung/Nominal power

6.0 VA

Safety transformer
 VDE 0570 / EN 61558 / ENEC10 approved
 Vacuum casting
 Temperature class ta70°C/B
 Cul weight: 30 g
 Total weight: 190 g

Ausführung / version

0

Raster / pitch **27.5 mm** Stifte / pinning **2 x 5**



Bestell Nr. <i>Order No.</i>	Primär [V] <i>Primary</i>	Sekundär [V] <i>Secondary</i>	Strom [mA] <i>Current</i>	Stiftbelegung <i>Pin configuration</i>	Leerlaufspannung [V] <i>No load voltage</i>	Prüfzeichen / Approvals		
						VDE	5085-2/3	5085-1/2

VN42.14/15519	230	6	1000	1-5 / 7-9	8,75	●		
VN42.14/15520	230	9	667	1-5 / 7-9	13,30	●		
VN42.14/15521	230	12	500	1-5 / 7-9	16,85	●		
VN42.14/15522	230	15	400	1-5 / 7-9	20,60	●		
VN42.14/15523	230	18	333	1-5 / 7-9	24,55	●		
VN42.14/15524	230	24	250	1-5 / 7-9	30,50	●		
VN42.14/15525	230	2x6	2x500	1-5 / 6-7+9-10	2x8,70	●		
VN42.14/15526	230	2x7,5	2x400	1-5 / 6-7+9-10	2x11,00	●		
VN42.14/15527	230	2x9	2x333	1-5 / 6-7+9-10	2x13,40	●		
VN42.14/15528	230	2x12	2x250	1-5 / 6-7+9-10	2x16,80	●		
VN42.14/15529	230	2x15	2x200	1-5 / 6-7+9-10	2x20,75	●		
VN42.14/15530	230	2x18	2x167	1-5 / 6-7+9-10	2x24,70	●		
VN42.14/15531	230	2x24	2x125	1-5 / 6-7+9-10	2x30,70	●		

VN42.14/25519	115	6	1000	1-5 / 7-9	8,75	●		
VN42.14/25520	115	9	667	1-5 / 7-9	13,30	●		
VN42.14/25521	115	12	500	1-5 / 7-9	16,85	●		
VN42.14/25522	115	15	400	1-5 / 7-9	20,60	●		
VN42.14/25523	115	18	333	1-5 / 7-9	24,55	●		
VN42.14/25524	115	24	250	1-5 / 7-9	30,50	●		
VN42.14/25525	115	2x6	2x500	1-5 / 6-7+9-10	2x8,70	●		
VN42.14/25526	115	2x7,5	2x400	1-5 / 6-7+9-10	2x11,00	●		
VN42.14/25527	115	2x9	2x333	1-5 / 6-7+9-10	2x13,40	●		
VN42.14/25528	115	2x12	2x250	1-5 / 6-7+9-10	2x16,80	●		
VN42.14/25529	115	2x15	2x200	1-5 / 6-7+9-10	2x20,75	●		
VN42.14/25530	115	2x18	2x167	1-5 / 6-7+9-10	2x24,70	●		
VN42.14/25531	115	2x24	2x125	1-5 / 6-7+9-10	2x30,70	●		

Trenntransformator / isolation transformer

Typ/Type

EI42/14,8

Sicherheitstransformator
 VDE 0570 / EN 61558 / ENEC10 geprüft
 Vakuumverguss
 Temperaturklasse ta70°C/B
 Cul-Gewicht: 30 g
 Gesamt-Gewicht: 190 g

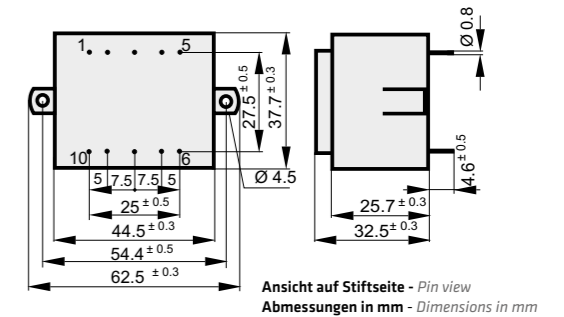

Nennleistung/Nominal power

6.0 VA

Safety transformer
 VDE 0570 / EN 61558 / ENEC10 approved
 Vacuum casting
 Temperature class ta70°C/B
 Cul weight: 30 g
 Total weight: 190 g

Ausführung / version

K

Raster / pitch **27.5 mm** Stifte / pinning **2 x 5**



Bestell Nr. <i>Order No.</i>	Primär [V] <i>Primary</i>	Sekundär [V] <i>Secondary</i>	Strom [mA] <i>Current</i>	Stiftbelegung <i>Pin configuration</i>	Leerlaufspannung [V] <i>No load voltage</i>	Prüfzeichen / Approvals		
						VDE	5085-2/3	5085-1/2

VN42.14/15465	230	6	1000	1-5 / 7-9	8,75	●		
VN42.14/15466	230	9	667	1-5 / 7-9	13,30	●		
VN42.14/15467	230	12	500	1-5 / 7-9	16,85	●		
VN42.14/15468	230	15	400	1-5 / 7-9	20,60	●		
VN42.14/15469	230	18	333	1-5 / 7-9	24,55	●		
VN42.14/15470	230	24	250	1-5 / 7-9	30,50	●		
VN42.14/15471	230	2x6	2x500	1-5 / 6-7+9-10	2x8,70	●		
VN42.14/15472	230	2x7,5	2x400	1-5 / 6-7+9-10	2x11,00	●		
VN42.14/15473	230	2x9	2x333	1-5 / 6-7+9-10	2x13,40	●		
VN42.14/15474	230	2x12	2x250	1-5 / 6-7+9-10	2x16,80	●		
VN42.14/15475	230	2x15	2x200	1-5 / 6-7+9-10	2x20,75	●		
VN42.14/15476	230	2x18	2x167	1-5 / 6-7+9-10	2x24,70	●		
VN42.14/15477	230	2x24	2x125	1-5 / 6-7+9-10	2x30,70	●		

VN42.14/25431	115	6	1000	1-5 / 7-9	8,75	●		
VN42.14/25432	115	9	667	1-5 / 7-9	13,30	●		
VN42.14/25433	115	12	500	1-5 / 7-9	16,85	●		
VN42.14/25434	115	15	400	1-5 / 7-9	20,60	●		
VN42.14/25435	115	18	333	1-5 / 7-9	24,55	●		
VN42.14/25436	115	24	250	1-5 / 7-9	30,50	●		
VN42.14/25437	115	2x6	2x500	1-5 / 6-7+9-10	2x8,70	●		
VN42.14/25438	115	2x7,5	2x400	1-5 / 6-7+9-10	2x11,00	●		
VN42.14/25439	115	2x9	2x333	1-5 / 6-7+9-10	2x13,40	●		
VN42.14/25440	115	2x12	2x250	1-5 / 6-7+9-10	2x16,80	●		
VN42.14/25441	115	2x15	2x200	1-5 / 6-7+9-10	2x20,75	●		
VN42.14/25442	115	2x18	2x167	1-5 / 6-7+9-10	2x24,70	●		
VN42.14/25443	115	2x24	2x125	1-5 / 6-7+9-10	2x30,70	●		

Trenntransformator / isolation transformer

Typ/Type

EI42/14,8

Sicherheitstransformator
 VDE 0570 / EN 61558 / ENEC10 geprüft
 Vakuumverguss
 Temperaturklasse ta70°C/B
 Cul-Gewicht: 30 g
 Gesamt-Gewicht: 190 g

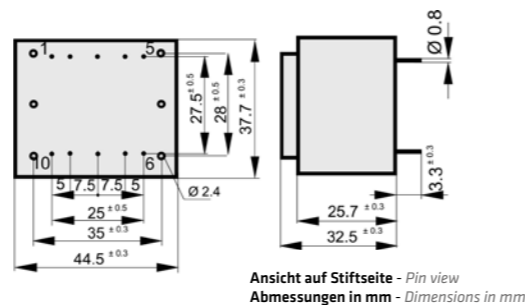

Nennleistung/Nominal power

6.0 VA

Safety transformer
 VDE 0570 / EN 61558 / ENEC10 approved
 Vacuum casting
 Temperature class ta70°C/B
 Cul weight: 30 g
 Total weight: 190 g

Ausführung / version

B0

Raster / pitch

27.5 mm 2 x 5

Stifte / pinning



Bestell Nr. <i>Order No.</i>	Primär [V] <i>Primary</i>	Sekundär [V] <i>Secondary</i>	Strom [mA] <i>Current</i>	Stiftbelegung <i>Pin configuration</i>	Leerlaufspannung [V] <i>No load voltage</i>	Prüfzeichen / Approvals		
						VDE	5085-2/3	5085-1/2

VN42.14/15374	230	6	1000	1-5 / 7-9	8,75	●		
VN42.14/15375	230	9	667	1-5 / 7-9	13,30	●		
VN42.14/15376	230	12	500	1-5 / 7-9	16,85	●		
VN42.14/15377	230	15	400	1-5 / 7-9	20,60	●		
VN42.14/15378	230	18	333	1-5 / 7-9	24,55	●		
VN42.14/15379	230	24	250	1-5 / 7-9	30,50	●		
VN42.14/15380	230	2x6	2x500	1-5 / 6-7+9-10	2x8,70	●		
VN42.14/15381	230	2x7,5	2x400	1-5 / 6-7+9-10	2x11,00	●		
VN42.14/15382	230	2x9	2x333	1-5 / 6-7+9-10	2x13,40	●		
VN42.14/15383	230	2x12	2x250	1-5 / 6-7+9-10	2x16,80	●		
VN42.14/15384	230	2x15	2x200	1-5 / 6-7+9-10	2x20,75	●		
VN42.14/15385	230	2x18	2x167	1-5 / 6-7+9-10	2x24,70	●		
VN42.14/15386	230	2x24	2x125	1-5 / 6-7+9-10	2x30,70	●		

VN42.14/25340	115	6	1000	1-5 / 7-9	8,75	●		
VN42.14/25341	115	9	667	1-5 / 7-9	13,30	●		
VN42.14/25342	115	12	500	1-5 / 7-9	16,85	●		
VN42.14/25343	115	15	400	1-5 / 7-9	20,60	●		
VN42.14/25344	115	18	333	1-5 / 7-9	24,55	●		
VN42.14/25345	115	24	250	1-5 / 7-9	30,50	●		
VN42.14/25346	115	2x6	2x500	1-5 / 6-7+9-10	2x8,70	●		
VN42.14/25347	115	2x7,5	2x400	1-5 / 6-7+9-10	2x11,00	●		
VN42.14/25348	115	2x9	2x333	1-5 / 6-7+9-10	2x13,40	●		
VN42.14/25349	115	2x12	2x250	1-5 / 6-7+9-10	2x16,80	●		
VN42.14/25350	115	2x15	2x200	1-5 / 6-7+9-10	2x20,75	●		
VN42.14/25351	115	2x18	2x167	1-5 / 6-7+9-10	2x24,70	●		
VN42.14/25352	115	2x24	2x125	1-5 / 6-7+9-10	2x30,70	●		

⊗ Trenntransformator / isolation transformer

Typ/Type

EI42/20,5

Sicherheitstransformator
 VDE 0570 / EN 61558 / ENEC10
 UL 506 / CSA geprüft
 Vakuumverguss
 Temperaturklasse ta70°C/B
 Cul-Gewicht: 40 g
 Gesamt-Gewicht: 252 g

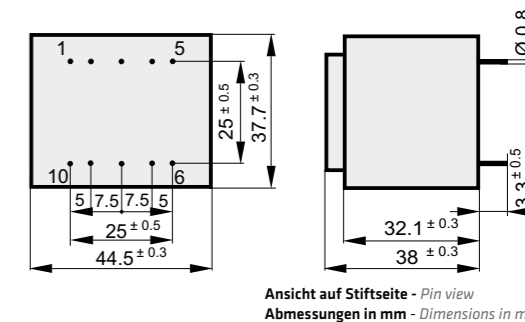

Nennleistung/Nominal power

8.0 VA

Safety transformer
 VDE 0570 / EN 61558 / ENEC10
 UL 506 / CSA approved
 Vacuum casting
 Temperature class ta70°C/B
 Cul weight: 40 g
 Total weight: 252 g

Ausführung / version

0

Raster / pitch

25 mm 2 x 5

Stifte / pinning



Bestell Nr. <i>Order No.</i>	Primär [V] <i>Primary</i>	Sekundär [V] <i>Secondary</i>	Strom [mA] <i>Current</i>	Stiftbelegung <i>Pin configuration</i>	Leerlaufspannung [V] <i>No load voltage</i>	Prüfzeichen / Approvals		
						VDE	5085-2/3	5085-1/2

VN42.20/15533	230	6	1333	1-5 / 7-9	7,80	●		●
VN42.20/15534	230	9	888	1-5 / 7-9	11,90	●		●
VN42.20/15535	230	12	666	1-5 / 7-9	15,75	●		●
VN42.20/15287	230	15	533	1-5 / 7-9	19,70	●		●
VN42.20/15536	230	18	444	1-5 / 7-9	23,50	●		●
VN42.20/15537	230	24	333	1-5 / 7-9	31,40	●		●
VN42.20/15538	230	2x6	2x666	1-5 / 6-7+9-10	2x7,85	●		●
VN42.20/15539	230	2x7,5	2x533	1-5 / 6-7+9-10	2x9,70	●		●
VN42.20/15540	230	2x9	2x444	1-5 / 6-7+9-10	2x12,00	●		●
VN42.20/15333	230	2x12	2x333	1-5 / 6-7+9-10	2x15,70	●		●
VN42.20/15541	230	2x15	2x266	1-5 / 6-7+9-10	2x19,65	●		●
VN42.20/15542	230	2x18	2x222	1-5 / 6-7+9-10	2x23,70	●		●
VN42.20/15543	230	2x24	2x166	1-5 / 6-7+9-10	2x31,40	●		●

⊗ Trenntransformator / isolation transformer

Typ/Type

EI48/16,8

Sicherheitstransformator
 VDE 0570 / EN 61558 / ENEC10
 UL 506 / CSA geprüft
 Vakuumverguss
 Temperaturklasse ta70°C/B
 Cul-Gewicht: 50 g
 Gesamt-Gewicht: 275 g

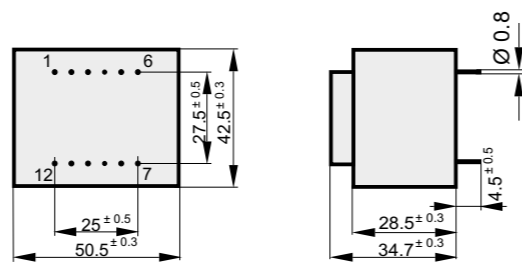

Ansicht auf Stiftseite - Pin view
 Abmessungen in mm - Dimensions in mm

Nennleistung/Nominal power

10.0 VA

Safety transformer
 VDE 0570 / EN 61558 / ENEC10
 UL 506 / CSA approved
 Vacuum casting
 Temperature class ta70°C/B
 Cul weight: 50 g
 Total weight: 275 g

Ausführung / version

0

Raster / pitch **27.5 mm** Stifte / pinning **2 x 6**



Bestell Nr. <i>Order No.</i>	Primär [V] <i>Primary</i>	Sekundär [V] <i>Secondary</i>	Strom [mA] <i>Current</i>	Stiftbelegung <i>Pin configuration</i>	Leerlaufspannung [V] <i>No load voltage</i>	Prüfzeichen / Approvals		
						VDE	5085-2/3	5085-1/2

V48.16/16441	230	6	1666	1-6 / 8-11	7,40	●		●
V48.16/16442	230	9	1111	1-6 / 8-11	11,30	●		●
V48.16/16443	230	12	833	1-6 / 8-11	15,10	●		●
V48.16/16444	230	15	666	1-6 / 8-11	18,80	●		●
V48.16/16445	230	18	555	1-6 / 8-11	22,60	●		●
V48.16/16446	230	24	416	1-6 / 8-11	29,10	●		●
V48.16/16447	230	2x6	2x833	1-6 / 7-8 + 11-12	2x7,50	●		●
V48.16/16448	230	2x7,5	2x666	1-6 / 7-8 + 11-12	2x9,60	●		●
V48.16/16449	230	2x9	2x555	1-6 / 7-8 + 11-12	2x11,30	●		●
V48.16/16450	230	2x12	2x416	1-6 / 7-8 + 11-12	2x15,00	●		●
V48.16/16451	230	2x15	2x333	1-6 / 7-8 + 11-12	2x18,90	●		●
V48.16/16452	230	2x18	2x277	1-6 / 7-8 + 11-12	2x22,50	●		●
V48.16/16453	230	2x24	2x208	1-6 / 7-8 + 11-12	2x29,00	●		●

V48.16/26413	115	6	1666	1-6 / 8-11	7,40	●		●
V48.16/26414	115	9	1111	1-6 / 8-11	11,30	●		●
V48.16/26415	115	12	833	1-6 / 8-11	15,10	●		●
V48.16/26416	115	15	666	1-6 / 8-11	18,80	●		●
V48.16/26417	115	18	555	1-6 / 8-11	22,60	●		●
V48.16/26418	115	24	416	1-6 / 8-11	29,10	●		●
V48.16/26419	115	2x6	2x833	1-6 / 7-8 + 11-12	2x7,50	●		●
V48.16/26420	115	2x7,5	2x666	1-6 / 7-8 + 11-12	2x9,60	●		●
V48.16/26421	115	2x9	2x555	1-6 / 7-8 + 11-12	2x11,30	●		●
V48.16/26422	115	2x12	2x416	1-6 / 7-8 + 11-12	2x15,00	●		●
V48.16/26423	115	2x15	2x333	1-6 / 7-8 + 11-12	2x18,90	●		●
V48.16/26424	115	2x18	2x277	1-6 / 7-8 + 11-12	2x22,50	●		●
V48.16/26425	115	2x24	2x208	1-6 / 7-8 + 11-12	2x29,00	●		●

Trenntransformator / isolation transformer

Typ/Type

EI48/16,8

Sicherheitstransformator
 VDE 0570 / EN 61558 / ENEC10
 UL 506 / CSA geprüft
 Vakuumverguss
 Temperaturklasse ta70°C/B
 Cul-Gewicht: 50 g
 Gesamt-Gewicht: 275 g

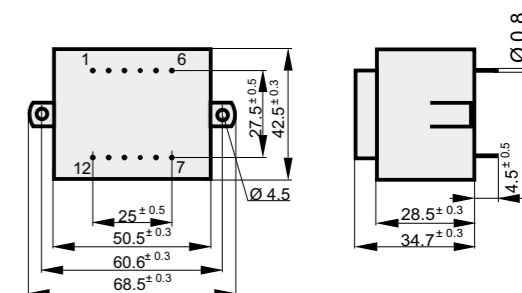

Ansicht auf Stiftseite - Pin view
 Abmessungen in mm - Dimensions in mm

Nennleistung/Nominal power

10.0 VA

Safety transformer
 VDE 0570 / EN 61558 / ENEC10
 UL 506 / CSA approved
 Vacuum casting
 Temperature class ta70°C/B
 Cul weight: 50 g
 Total weight: 275 g

Ausführung / version

K

Raster / pitch **27.5 mm** Stifte / pinning **2 x 6**



Bestell Nr. <i>Order No.</i>	Primär [V] <i>Primary</i>	Sekundär [V] <i>Secondary</i>	Strom [mA] <i>Current</i>	Stiftbelegung <i>Pin configuration</i>	Leerlaufspannung [V] <i>No load voltage</i>	Prüfzeichen / Approvals		
						VDE	5085-2/3	5085-1/2

V48.16/16400	230	6	1666	1-6 / 8-11	7,40	●		●
V48.16/16401	230	9	1111	1-6 / 8-11	11,30	●		●
V48.16/16402	230	12	833	1-6 / 8-11	15,10	●		●
V48.16/16403	230	15	666	1-6 / 8-11	18,80	●		●
V48.16/16404	230	18	555	1-6 / 8-11	22,60	●		●
V48.16/16405	230	24	416	1-6 / 8-11	29,10	●		●
V48.16/16406	230	2x6	2x833	1-6 / 7-8 + 11-12	2x7,50	●		●
V48.16/16407	230	2x7,5	2x666	1-6 / 7-8 + 11-12	2x9,60	●		●
V48.16/16408	230	2x9	2x555	1-6 / 7-8 + 11-12	2x11,30	●		●
V48.16/16409	230	2x12	2x416	1-6 / 7-8 + 11-12	2x15,00	●		●
V48.16/16410	230	2x15	2x333	1-6 / 7-8 + 11-12	2x18,90	●		●
V48.16/16411	230	2x18	2x277	1-6 / 7-8 + 11-12	2x22,50	●		●
V48.16/16412	230	2x24	2x208	1-6 / 7-8 + 11-12	2x29,00	●		●

V48.16/26400	115	6	1666	1-6 / 8-11	7,40	●		●
V48.16/26401	115	9	1111	1-6 / 8-11	11,30	●		●
V48.16/26402	115	12	833	1-6 / 8-11	15,10	●		●
V48.16/26403	115	15	666	1-6 / 8-11	18,80	●		●
V48.16/26404	115	18	555	1-6 / 8-11	22,60	●		●
V48.16/26405	115	24	416	1-6 / 8-11	29,10	●		●
V48.16/26406	115	2x6	2x833	1-6 / 7-8 + 11-12	2x7,50	●		●
V48.16/26407	115	2x7,5	2x666	1-6 / 7-8 + 11-12	2x9,60	●		●
V48.16/26408	115	2x9	2x555	1-6 / 7-8 + 11-12	2x11,30	●		●
V48.16/26409	115	2x12	2x416	1-6 / 7-8 + 11-12	2x15,00	●		●
V48.16/26410	115	2x15	2x333	1-6 / 7-8 + 11-12	2x18,90	●		●
V48.16/26411	115	2x18	2x277	1-6 / 7-8 + 11-12	2x22,50	●		●
V48.16/26412	115	2x24	2x208	1-6 / 7-8 + 11-12	2x29,00	●		●

Trenntransformator / isolation transformer

Typ/Type

EI48/16,8

Sicherheitstransformator
 VDE 0570 / EN 61558 / ENEC10
 UL 506 / CSA geprüft
 Vakuumverguss
 Temperaturklasse ta70°C/B
 Cul-Gewicht: 50 g
 Gesamt-Gewicht: 275 g

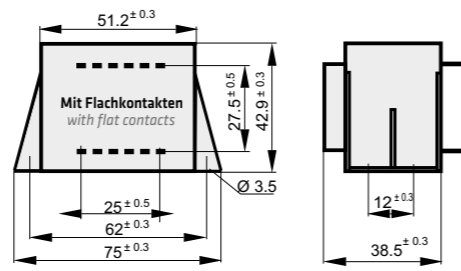

Ansicht auf Stiftseite - Pin view
 Abmessungen in mm - Dimensions in mm

Ausführung / version

VL

Nennleistung/Nominal power

10.0 VA

Safety transformer
 VDE 0570 / EN 61558 / ENEC10
 UL 506 / CSA approved
 Vacuum casting
 Temperature class ta70°C/B
 Cul weight: 50 g
 Total weight: 275 g



Bestell Nr. <i>Order No.</i>	Primär [V] <i>Primary</i>	Sekundär [V] <i>Secondary</i>	Strom [mA] <i>Current</i>	Stiftbelegung <i>Pin configuration</i>	Leerlaufspannung [V] <i>No load voltage</i>	Prüfzeichen / Approvals		
						VDE	5085-2/3	5085-1/2

V48.16/16454	230	6	1666	1-6 / 8-11	7,40	●		●
V48.16/16455	230	9	1111	1-6 / 8-11	11,30	●		●
V48.16/16456	230	12	833	1-6 / 8-11	15,10	●		●
V48.16/16457	230	15	666	1-6 / 8-11	18,80	●		●
V48.16/16458	230	18	555	1-6 / 8-11	22,60	●		●
V48.16/16459	230	24	416	1-6 / 8-11	29,10	●		●
V48.16/16460	230	2x6	2x833	1-6 / 7-8 + 11-12	2x7,50	●		●
V48.16/16461	230	2x7,5	2x666	1-6 / 7-8 + 11-12	2x9,60	●		●
V48.16/16462	230	2x9	2x555	1-6 / 7-8 + 11-12	2x11,30	●		●
V48.16/16463	230	2x12	2x416	1-6 / 7-8 + 11-12	2x15,00	●		●
V48.16/16464	230	2x15	2x333	1-6 / 7-8 + 11-12	2x18,90	●		●
V48.16/16465	230	2x18	2x277	1-6 / 7-8 + 11-12	2x22,50	●		●
V48.16/16466	230	2x24	2x208	1-6 / 7-8 + 11-12	2x29,00	●		●

V48.16/26426	115	6	1666	1-6 / 8-11	7,40	●		●
V48.16/26427	115	9	1111	1-6 / 8-11	11,30	●		●
V48.16/26428	115	12	833	1-6 / 8-11	15,10	●		●
V48.16/26429	115	15	666	1-6 / 8-11	18,80	●		●
V48.16/26430	115	18	555	1-6 / 8-11	22,60	●		●
V48.16/26431	115	24	416	1-6 / 8-11	29,10	●		●
V48.16/26432	115	2x6	2x833	1-6 / 7-8 + 11-12	2x7,50	●		●
V48.16/26433	115	2x7,5	2x666	1-6 / 7-8 + 11-12	2x9,60	●		●
V48.16/26434	115	2x9	2x555	1-6 / 7-8 + 11-12	2x11,30	●		●
V48.16/26435	115	2x12	2x416	1-6 / 7-8 + 11-12	2x15,00	●		●
V48.16/26436	115	2x15	2x333	1-6 / 7-8 + 11-12	2x18,90	●		●
V48.16/26437	115	2x18	2x277	1-6 / 7-8 + 11-12	2x22,50	●		●
V48.16/26438	115	2x24	2x208	1-6 / 7-8 + 11-12	2x29,00	●		●

Trenntransformator / isolation transformer

Typ/Type

EI48/16,8

Sicherheitstransformator
 VDE 0570 / EN 61558 / ENEC10
 UL 506 / CSA geprüft
 Vakuumverguss
 Temperaturklasse ta70°C/B
 Cul-Gewicht: 50 g
 Gesamt-Gewicht: 275 g

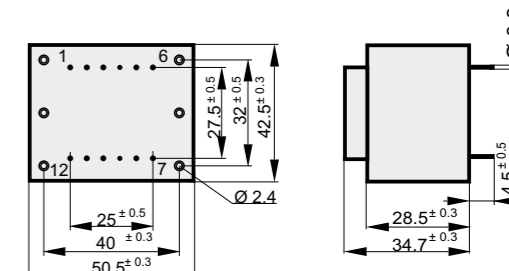

Ansicht auf Stiftseite - Pin view
 Abmessungen in mm - Dimensions in mm

Nennleistung/Nominal power

10.0 VA

Safety transformer
 VDE 0570 / EN 61558 / ENEC10
 UL 506 / CSA approved
 Vacuum casting
 Temperature class ta70°C/B
 Cul weight: 50 g
 Total weight: 275 g

Ausführung / version

BO

Raster / pitch

27.5 mm

Stifte / pinning

2 x 6



Bestell Nr. <i>Order No.</i>	Primär [V] <i>Primary</i>	Sekundär [V] <i>Secondary</i>	Strom [mA] <i>Current</i>	Stiftbelegung <i>Pin configuration</i>	Leerlaufspannung [V] <i>No load voltage</i>	Prüfzeichen / Approvals		
						VDE	5085-2/3	5085-1/2

V48.16/16467	230	6	1666	1-6 / 8-11	7,40	●		●
V48.16/16468	230	9	1111	1-6 / 8-11	11,30	●		●
V48.16/16469	230	12	833	1-6 / 8-11	15,10	●		●
V48.16/16470	230	15	666	1-6 / 8-11	18,80	●		●
V48.16/16471	230	18	555	1-6 / 8-11	22,60	●		●
V48.16/16472	230	24	416	1-6 / 8-11	29,10	●		●
V48.16/16473	230	2x6	2x833	1-6 / 7-8 + 11-12	2x7,50	●		●
V48.16/16474	230	2x7,5	2x666	1-6 / 7-8 + 11-12	2x9,60	●		●
V48.16/16475	230	2x9	2x555	1-6 / 7-8 + 11-12	2x11,30	●		●
V48.16/16476	230	2x12	2x416	1-6 / 7-8 + 11-12	2x15,00	●		●
V48.16/16477	230	2x15	2x333	1-6 / 7-8 + 11-12	2x18,90	●		●
V48.16/16478	230	2x18	2x277	1-6 / 7-8 + 11-12	2x22,50	●		●
V48.16/16479	230	2x24	2x208	1-6 / 7-8 + 11-12	2x29,00	●		●

V48.16/26439	115	6	1666	1-6 / 8-11	7,40	●		●
V48.16/26440	115	9	1111	1-6 / 8-11	11,30	●		●
V48.16/26441	115	12	833	1-6 / 8-11	15,10	●		●
V48.16/26442	115	15	666	1-6 / 8-11	18,80	●		●
V48.16/26443	115	18	555	1-6 / 8-11	22,60	●		●
V48.16/26444	115	24	416	1-6 / 8-11	29,10	●		●
V48.16/26445	115	2x6	2x833	1-6 / 7-8 + 11-12	2x7,50	●		●
V48.16/26446	115	2x7,5	2x666	1-6 / 7-8 + 11-12	2x9,60	●		●
V48.16/26447	115	2x9	2x555	1-6 / 7-8 + 11-12	2x11,30	●		●
V48.16/26448	115	2x12	2x416	1-6 / 7-8 + 11-12	2x15,00	●		●
V48.16/26449	115	2x15	2x333	1-6 / 7-8 + 11-12	2x18,90	●		●
V48.16/26450	115	2x18	2x277	1-6 / 7-8 + 11-12	2x22,50	●		●
V48.16/26451	115	2x24	2x208	1-6 / 7-8 + 11-12	2x29,00	●		●

Trenntransformator / isolation transformer

Typ/Type

EI48/20,5

Sicherheitstransformator
VDE 0570 / EN 61558 / ENEC10
UL 506 / CSA geprüft
Vakuummverguss
Temperaturklasse ta70°C/B
Cul-Gewicht: 60 g
Gesamt-Gewicht: 300 g

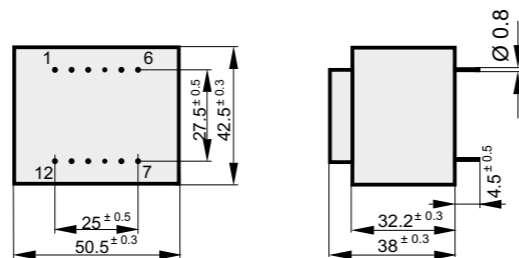

Ansicht auf Stiftseite - Pin view
Abmessungen in mm - Dimensions in mm

Nennleistung/Nominal power

12.0 VA

Safety transformer
VDE 0570 / EN 61558 / ENEC10
UL 506 / CSA approved
Vacuum casting
Temperature class ta70°C/B
Cul weight: 60 g
Total weight: 300 g

Ausführung / version

0

Raster / pitch

27.5 mm 2 x 6

Stifte / pinning



Bestell Nr. <i>Order No.</i>	Primär [V] <i>Primary</i>	Sekundär [V] <i>Secondary</i>	Strom [mA] <i>Current</i>	Stiftbelegung <i>Pin configuration</i>	Leerlaufspannung [V] <i>No load voltage</i>	Prüfzeichen / Approvals		
						VDE	5085-2/3	5085-1/2
V48.20/16332	230	6	2000	1-6 / 8-11	7,42	●		●
V48.20/16333	230	9	1333	1-6 / 8-11	11,35	●		●
V48.20/16334	230	12	1000	1-6 / 8-11	14,86	●		●
V48.20/16335	230	15	800	1-6 / 8-11	18,74	●		●
V48.20/16336	230	18	666	1-6 / 8-11	22,40	●		●
V48.20/16337	230	24	500	1-6 / 8-11	29,60	●		●
V48.20/16338	230	2x6	2x1000	1-6 / 7-8 + 11-12	2x7,44	●		●
V48.20/16339	230	2x7,5	2x800	1-6 / 7-8 + 11-12	2x9,30	●		●
V48.20/16340	230	2x9	2x666	1-6 / 7-8 + 11-12	2x11,35	●		●
V48.20/16341	230	2x12	2x500	1-6 / 7-8 + 11-12	2x14,85	●		●
V48.20/16342	230	2x15	2x400	1-6 / 7-8 + 11-12	2x18,60	●		●
V48.20/16343	230	2x18	2x333	1-6 / 7-8 + 11-12	2x22,40	●		●
V48.20/16344	230	2x24	2x250	1-6 / 7-8 + 11-12	2x29,60	●		●

Trenntransformator / isolation transformer

Typ/Type

EI48/20,5

Sicherheitstransformator
VDE 0570 / EN 61558 / ENEC10
UL 506 / CSA geprüft
Vakuummverguss
Temperaturklasse ta70°C/B
Cul-Gewicht: 60 g
Gesamt-Gewicht: 300 g

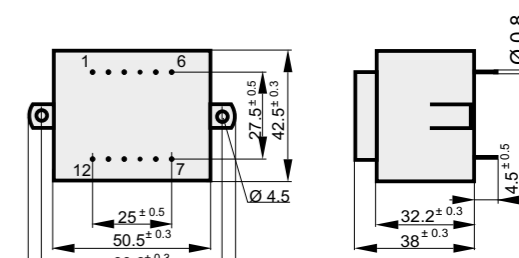

Ansicht auf Stiftseite - Pin view
Abmessungen in mm - Dimensions in mm

Nennleistung/Nominal power

12.0 VA

Safety transformer
VDE 0570 / EN 61558 / ENEC10
UL 506 / CSA approved
Vacuum casting
Temperature class ta70°C/B
Cul weight: 60 g
Total weight: 300 g

Ausführung / version

K

Raster / pitch

27.5 mm 2 x 6

Stifte / pinning



Bestell Nr. <i>Order No.</i>	Primär [V] <i>Primary</i>	Sekundär [V] <i>Secondary</i>	Strom [mA] <i>Current</i>	Stiftbelegung <i>Pin configuration</i>	Leerlaufspannung [V] <i>No load voltage</i>	Prüfzeichen / Approvals		
						VDE	5085-2/3	5085-1/2
V48.20/16300	230	6	2000	1-6 / 8-11	7,42	●		●
V48.20/16301	230	9	1333	1-6 / 8-11	11,35	●		●
V48.20/16302	230	12	1000	1-6 / 8-11	14,86	●		●
V48.20/16303	230	15	800	1-6 / 8-11	18,74	●		●
V48.20/16304	230	18	666	1-6 / 8-11	22,40	●		●
V48.20/16305	230	24	500	1-6 / 8-11	29,60	●		●
V48.20/16307	230	2x6	2x1000	1-6 / 7-8 + 11-12	2x7,44	●		●
V48.20/16308	230	2x7,5	2x800	1-6 / 7-8 + 11-12	2x9,30	●		●
V48.20/16309	230	2x9	2x666	1-6 / 7-8 + 11-12	2x11,35	●		●
V48.20/16310	230	2x12	2x500	1-6 / 7-8 + 11-12	2x14,85	●		●
V48.20/16311	230	2x15	2x400	1-6 / 7-8 + 11-12	2x18,60	●		●
V48.20/16312	230	2x18	2x333	1-6 / 7-8 + 11-12	2x22,40	●		●
V48.20/16313	230	2x24	2x250	1-6 / 7-8 + 11-12	2x29,60	●		●

Trenntransformator / isolation transformer

Typ/Type

EI48/20,5

Sicherheitstransformator
 VDE 0570 / EN 61558 / ENEC10
 UL 506 / CSA geprüft
 Vakuumverguss
 Temperaturklasse ta70°C/B
 Cul-Gewicht: 60 g
 Gesamt-Gewicht: 300 g

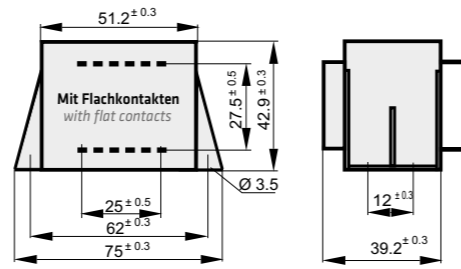

Ansicht auf Stiftseite - Pin view
 Abmessungen in mm - Dimensions in mm

Ausführung / version

VL

Nennleistung/Nominal power

12.0 VA

Safety transformer
 VDE 0570 / EN 61558 / ENEC10
 UL 506 / CSA approved
 Vacuum casting
 Temperature class ta70°C/B
 Cul weight: 60 g
 Total weight: 300 g



Bestell Nr. <i>Order No.</i>	Primär [V] <i>Primary</i>	Sekundär [V] <i>Secondary</i>	Strom [mA] <i>Current</i>	Stiftbelegung <i>Pin configuration</i>	Leerlaufspannung [V] <i>No load voltage</i>	Prüfzeichen / Approvals		
						VDE	5085-2/3	5085-1/2
V48.20/16345	230	6	2000	1-6 / 8-11	7,42	●		●
V48.20/16346	230	9	1333	1-6 / 8-11	11,35	●		●
V48.20/16347	230	12	1000	1-6 / 8-11	14,86	●		●
V48.20/16348	230	15	800	1-6 / 8-11	18,74	●		●
V48.20/16349	230	18	666	1-6 / 8-11	22,40	●		●
V48.20/16350	230	24	500	1-6 / 8-11	29,60	●		●
V48.20/16351	230	2x6	2x1000	1-6 / 7-8 + 11-12	2x7,44	●		●
V48.20/16352	230	2x7,5	2x800	1-6 / 7-8 + 11-12	2x9,30	●		●
V48.20/16353	230	2x9	2x666	1-6 / 7-8 + 11-12	2x11,35	●		●
V48.20/16354	230	2x12	2x500	1-6 / 7-8 + 11-12	2x14,85	●		●
V48.20/16355	230	2x15	2x400	1-6 / 7-8 + 11-12	2x18,60	●		●
V48.20/16356	230	2x18	2x333	1-6 / 7-8 + 11-12	2x22,40	●		●
V48.20/16357	230	2x24	2x250	1-6 / 7-8 + 11-12	2x29,60	●		●

Trenntransformator / isolation transformer

Typ/Type

EI48/20,5

Sicherheitstransformator
 VDE 0570 / EN 61558 / ENEC10
 UL 506 / CSA geprüft
 Vakuumverguss
 Temperaturklasse ta70°C/B
 Cul-Gewicht: 60 g
 Gesamt-Gewicht: 300 g

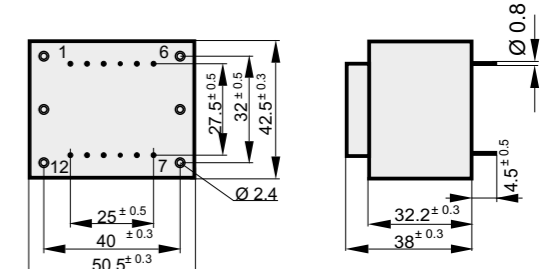

Ansicht auf Stiftseite - Pin view
 Abmessungen in mm - Dimensions in mm

Nennleistung/Nominal power

12.0 VA

Safety transformer
 VDE 0570 / EN 61558 / ENEC10
 UL 506 / CSA approved
 Vacuum casting
 Temperature class ta70°C/B
 Cul weight: 60 g
 Total weight: 300 g

Ausführung / version

B0

Raster / pitch

27.5 mm

Stifte / pinning

2 x 6



Bestell Nr. <i>Order No.</i>	Primär [V] <i>Primary</i>	Sekundär [V] <i>Secondary</i>	Strom [mA] <i>Current</i>	Stiftbelegung <i>Pin configuration</i>	Leerlaufspannung [V] <i>No load voltage</i>	Prüfzeichen / Approvals		
						VDE	5085-2/3	5085-1/2
V48.20/16358	230	6	2000	1-6 / 8-11	7,42	●		●
V48.20/16359	230	9	1333	1-6 / 8-11	11,35	●		●
V48.20/16360	230	12	1000	1-6 / 8-11	14,86	●		●
V48.20/16361	230	15	800	1-6 / 8-11	18,74	●		●
V48.20/16362	230	18	666	1-6 / 8-11	22,40	●		●
V48.20/16363	230	24	500	1-6 / 8-11	29,60	●		●
V48.20/16364	230	2x6	2x1000	1-6 / 7-8 + 11-12	2x7,44	●		●
V48.20/16365	230	2x7,5	2x800	1-6 / 7-8 + 11-12	2x9,30	●		●
V48.20/16366	230	2x9	2x666	1-6 / 7-8 + 11-12	2x11,35	●		●
V48.20/16367	230	2x12	2x500	1-6 / 7-8 + 11-12	2x14,85	●		●
V48.20/16368	230	2x15	2x400	1-6 / 7-8 + 11-12	2x18,60	●		●
V48.20/16369	230	2x18	2x333	1-6 / 7-8 + 11-12	2x22,40	●		●
V48.20/16370	230	2x24	2x250	1-6 / 7-8 + 11-12	2x29,60	●		●

Trenntransformator / isolation transformer

Typ/Type

EI48/25,5

Sicherheitstransformator
VDE 0570 / EN 61558 / ENEC10
UL 506 / CSA geprüft
Vakuummverguss
Temperaturklasse ta70°C/B
Cul-Gewicht: 65 g
Gesamt-Gewicht: 310 g

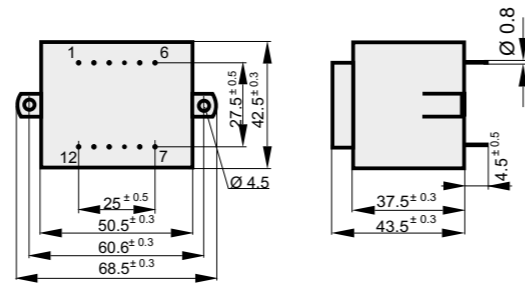

Ansicht auf Stiftseite - Pin view
Abmessungen in mm - Dimensions in mm

Nennleistung/Nominal power

15.0 VA

Safety transformer
VDE 0570 / EN 61558 / ENEC10
UL 506 / CSA approved
Vacuum casting
Temperature class ta70°C/B
Cul weight: 65 g
Total weight: 310 g

Ausführung / version

K

Raster / pitch

27.5 mm 2 x 6

Stifte / pinning



Bestell Nr. <i>Order No.</i>	Primär [V] <i>Primary</i>	Sekundär [V] <i>Secondary</i>	Strom [mA] <i>Current</i>	Stiftbelegung <i>Pin configuration</i>	Leerlaufspannung [V] <i>No load voltage</i>	Prüfzeichen / Approvals		
						VDE	5085-2/3	5085-1/2
V48.25/16480	230	6	2500	1-6 / 8-11	7,55	●		●
V48.25/16481	230	9	1666	1-6 / 8-11	11,22	●		●
V48.25/16482	230	12	1250	1-6 / 8-11	14,82	●		●
V48.25/16483	230	15	1000	1-6 / 8-11	18,51	●		●
V48.25/16484	230	18	833	1-6 / 8-11	22,47	●		●
V48.25/16485	230	24	625	1-6 / 8-11	29,60	●		●
V48.25/16486	230	2x6	2x1250	1-6 / 7-8 + 11-12	2x7,52	●		●
V48.25/16487	230	2x7,5	2x1000	1-6 / 7-8 + 11-12	2x9,23	●		●
V48.25/16488	230	2x9	2x833	1-6 / 7-8 + 11-12	2x11,24	●		●
V48.25/16489	230	2x12	2x625	1-6 / 7-8 + 11-12	2x14,95	●		●
V48.25/16490	230	2x15	2x500	1-6 / 7-8 + 11-12	2x18,53	●		●
V48.25/16491	230	2x18	2x416	1-6 / 7-8 + 11-12	2x22,20	●		●

Typ/Type

EI54/14

Sicherheitstransformator
nach VDE 0570 / EN 61558
UL 506 / CSA
Vakuummverguss
Temperaturklasse ta70°C/B
Cul-Gewicht: 75 g
Gesamt-Gewicht: 350 g

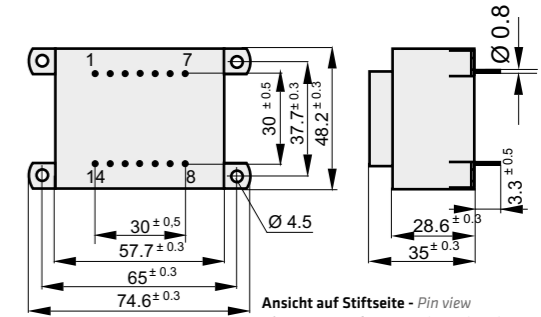

Ansicht auf Stiftseite - Pin view
Abmessungen in mm - Dimensions in mm

Nennleistung/Nominal power

12.0 VA

Safety transformer
according to VDE 0570 / EN 61558
UL 506 / CSA
Vacuum casting
Temperature class ta70°C/B
Cul weight: 75 g
Total weight: 350 g

Ausführung / version

KK

Raster / pitch

30 mm 2 x 7

Stifte / pinning



Bestell Nr. <i>Order No.</i>	Primär [V] <i>Primary</i>	Sekundär [V] <i>Secondary</i>	Strom [mA] <i>Current</i>	Stiftbelegung <i>Pin configuration</i>	Leerlaufspannung [V] <i>No load voltage</i>	Prüfzeichen / Approvals		
						VDE	5085-2/3	5085-1/2
V54.14/17543	230	6	2.000	1-7 / 9-13	8,00			●
V54.14/17544	230	9	1.330	1-7 / 9-13	11,80			●
V54.14/17545	230	12	1.000	1-7 / 9-13	16,00			●
V54.14/17546	230	15	800	1-7 / 9-13	19,80			●
V54.14/17547	230	18	667	1-7 / 9-13	24,00			●
V54.14/17548	230	24	500	1-7 / 9-13	31,90			●
V54.14/17549	230	2x6	2x 1.000	1-7 / 8-9 + 13-14	2x8,00			●
V54.14/17550	230	2x9	2x 667	1-7 / 8-9 + 13-14	2x11,80			●
V54.14/17551	230	2x12	2x 500	1-7 / 8-9 + 13-14	2x15,90			●
V54.14/17552	230	2x15	2x 400	1-7 / 8-9 + 13-14	2x19,80			●
V54.14/17553	230	2x18	2x 300	1-7 / 8-9 + 13-14	2x23,50			●

Typ/Type

EI54/18,8

Sicherheitstransformator
VDE 0570 / EN 61558 / ENEC10
UL 506 / CSA geprüft
Vakuumverguss
Temperaturklasse ta70°C/B
Cul-Gewicht: 80 g
Gesamt-Gewicht: 417 g

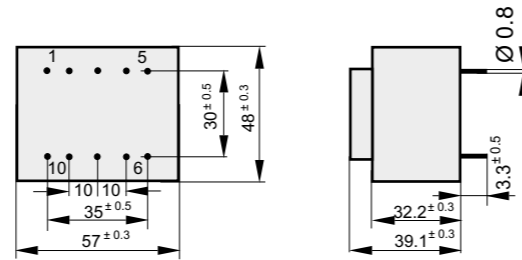

Ansicht auf Stiftseite - Pin view
Abmessungen in mm - Dimensions in mm

Nennleistung/Nominal power

16.0 VA

Safety transformer
VDE 0570 / EN 61558 / ENEC10
UL 506 / CSA approved
Vacuum casting
Temperature class ta70°C/B
Cul weight: 80 g
Total weight: 417 g

Ausführung / version

0

Raster / pitch

30 mm

Stifte / pinning

2 x 5



Bestell Nr. <i>Order No.</i>	Primär [V] <i>Primary</i>	Sekundär [V] <i>Secondary</i>	Strom [mA] <i>Current</i>	Stiftbelegung <i>Pin configuration</i>	Leerlaufspannung [V] <i>No load voltage</i>	Prüfzeichen / Approvals		
						VDE	5085-2/3	5085-1/2

V54.18/17214	230	6	2666	1-5 / 7-9	7,53	●		●
V54.18/17215	230	9	1777	1-5 / 7-9	11,25	●		●
V54.18/17216	230	12	1333	1-5 / 7-9	14,95	●		●
V54.18/17217	230	15	1066	1-5 / 7-9	18,65	●		●
V54.18/17218	230	18	888	1-5 / 7-9	21,75	●		●
V54.18/17219	230	24	666	1-5 / 7-9	29,50	●		●
V54.18/17220	230	2x6	2x1333	1-5 / 6-7 + 9-10	2x7,53	●		●
V54.18/17221	230	2x9	2x888	1-5 / 6-7 + 9-10	2x11,20	●		●
V54.18/17222	230	2x12	2x666	1-5 / 6-7 + 9-10	2x14,90	●		●
V54.18/17223	230	2x15	2x533	1-5 / 6-7 + 9-10	2x18,40	●		●
V54.18/17224	230	2x18	2x444	1-5 / 6-7 + 9-10	2x22,30	●		●
V54.18/17225	230	2x24	2x333	1-5 / 6-7 + 9-10	2x29,30	●		●

V54.18/27214	115	6	2666	1-5 / 7-9	7,53	●		●
V54.18/27215	115	9	1777	1-5 / 7-9	11,25	●		●
V54.18/27216	115	12	1333	1-5 / 7-9	14,95	●		●
V54.18/27217	115	15	1066	1-5 / 7-9	18,65	●		●
V54.18/27218	115	18	888	1-5 / 7-9	21,75	●		●
V54.18/27219	115	24	666	1-5 / 7-9	29,50	●		●
V54.18/27220	115	2x6	2x1333	1-5 / 6-7 + 9-10	2x7,53	●		●
V54.18/27221	115	2x9	2x888	1-5 / 6-7 + 9-10	2x11,20	●		●
V54.18/27222	115	2x12	2x666	1-5 / 6-7 + 9-10	2x14,90	●		●
V54.18/27223	115	2x15	2x533	1-5 / 6-7 + 9-10	2x18,40	●		●
V54.18/27224	115	2x18	2x444	1-5 / 6-7 + 9-10	2x22,30	●		●
V54.18/27225	115	2x24	2x333	1-5 / 6-7 + 9-10	2x29,30	●		●

⊖ Trenntransformator / isolation transformer

Typ/Type

EI54/18,8

Sicherheitstransformator
VDE 0570 / EN 61558 / ENEC10
UL 506 / CSA geprüft
Vakuumverguss
Temperaturklasse ta70°C/B
Cul-Gewicht: 80 g
Gesamt-Gewicht: 417 g

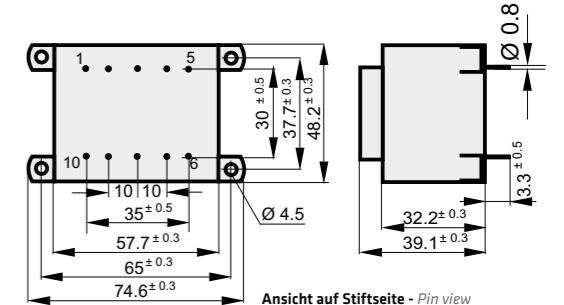

Ansicht auf Stiftseite - Pin view
Abmessungen in mm - Dimensions in mm

Nennleistung/Nominal power

16.0 VA

Safety transformer
VDE 0570 / EN 61558 / ENEC10
UL 506 / CSA approved
Vacuum casting
Temperature class ta70°C/B
Cul weight: 80 g
Total weight: 417 g

Ausführung / version

KK

Raster / pitch

30 mm

Stifte / pinning

2 x 5



Bestell Nr. <i>Order No.</i>	Primär [V] <i>Primary</i>	Sekundär [V] <i>Secondary</i>	Strom [mA] <i>Current</i>	Stiftbelegung <i>Pin configuration</i>	Leerlaufspannung [V] <i>No load voltage</i>	Prüfzeichen / Approvals		
						VDE	5085-2/3	5085-1/2

V54.18/17200	230	6	2666	1-5 / 7-9	7,20	●		●
V54.18/17201	230	9	1777	1-5 / 7-9	11,10	●		●
V54.18/17202	230	12	1333	1-5 / 7-9	14,80	●		●
V54.18/17203	230	15	1066	1-5 / 7-9	18,50	●		●
V54.18/17204	230	18	888	1-5 / 7-9	21,70	●		●
V54.18/17205	230	24	666	1-5 / 7-9	29,70	●		●
V54.18/17207	230	2x6	2x1333	1-5 / 6-7 + 9-10	2x7,40	●		●
V54.18/17208	230	2x7,5	2x1066	1-5 / 6-7 + 9-10	2x9,20	●		●
V54.18/17209	230	2x9	2x888	1-5 / 6-7 + 9-10	2x11,10	●		●
V54.18/17210	230	2x12	2x666	1-5 / 6-7 + 9-10	2x14,80	●		●
V54.18/17211	230	2x15	2x533	1-5 / 6-7 + 9-10	2x18,50	●		●
V54.18/17212	230	2x18	2x444	1-5 / 6-7 + 9-10	2x21,80	●		●
V54.18/17213	230	2x24	2x333	1-5 / 6-7 + 9-10	2x29,80	●		●

V54.18/27200	115	6	2666	1-5 / 7-9	7,20	●		●
V54.18/27201	115	9	1777	1-5 / 7-9	11,10	●		●
V54.18/27202	115	12	1333	1-5 / 7-9	14,80	●		●
V54.18/27203	115	15	1066	1-5 / 7-9	18,50	●		●
V54.18/27204	115	18	888	1-5 / 7-9	21,70	●		●
V54.18/27205	115	24	666	1-5 / 7-9	29,70	●		●
V54.18/27207	115	2x6	2x1333	1-5 / 6-7 + 9-10	2x7,40	●		●
V54.18/27208	115	2x7,5	2x1066	1-5 / 6-7 + 9-10	2x9,20	●		●
V54.18/27209	115	2x9	2x888	1-5 / 6-7 + 9-10	2x11,10	●		●
V54.18/27210	115	2x12	2x666	1-5 / 6-7 + 9-10	2x14,80	●		●
V54.18/27211	115	2x15	2x533	1-5 / 6-7 + 9-10	2x18,50	●		●
V54.18/27212	115	2x18	2x444	1-5 / 6-7 + 9-10	2x21,80	●		●
V54.18/27213	115	2x24	2x333	1-5 / 6-7 + 9-10	2x29,80	●		●

⊖ Trenntransformator / isolation transformer

Typ/Type

EI54/18,8

Sicherheitstransformator
 VDE 0570 / EN 61558 / ENEC10
 UL 506 / CSA geprüft
 Vakuumverguss
 Temperaturklasse ta70°C/B
 Cul-Gewicht: 80 g
 Gesamt-Gewicht: 417 g

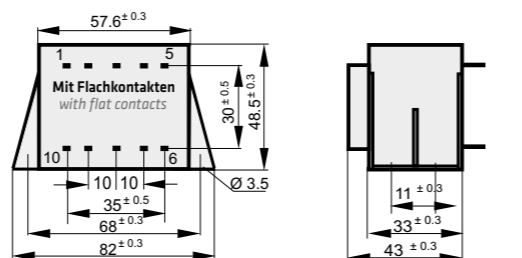

Ansicht auf Stiftseite - Pin view
 Abmessungen in mm - Dimensions in mm

Ausführung / version

VL

Nennleistung/Nominal power

16.0 VA

Safety transformer
 VDE 0570 / EN 61558 / ENEC10
 UL 506 / CSA approved
 Vacuum casting
 Temperature class ta70°C/B
 Cul weight: 80 g
 Total weight: 417 g



Bestell Nr. <i>Order No.</i>	Primär [V] <i>Primary</i>	Sekundär [V] <i>Secondary</i>	Strom [mA] <i>Current</i>	Stiftbelegung <i>Pin configuration</i>	Leerlaufspannung [V] <i>No load voltage</i>	Prüfzeichen / Approvals		
						VDE	5085-2/3	5085-1/2
V54.18/17226	230	6	2666	1-5 / 7-9	7,53	●		●
V54.18/17227	230	9	1777	1-5 / 7-9	11,25	●		●
V54.18/17228	230	12	1333	1-5 / 7-9	14,95	●		●
V54.18/17229	230	15	1066	1-5 / 7-9	18,65	●		●
V54.18/17230	230	18	888	1-5 / 7-9	21,75	●		●
V54.18/17231	230	24	666	1-5 / 7-9	29,50	●		●
V54.18/17232	230	2x6	2x1333	1-5 / 6-7 + 9-10	2x7,53	●		●
V54.18/17233	230	2x9	2x888	1-5 / 6-7 + 9-10	2x11,20	●		●
V54.18/17234	230	2x12	2x666	1-5 / 6-7 + 9-10	2x14,90	●		●
V54.18/17235	230	2x15	2x533	1-5 / 6-7 + 9-10	2x18,40	●		●
V54.18/17236	230	2x18	2x444	1-5 / 6-7 + 9-10	2x22,30	●		●
V54.18/17237	230	2x24	2x333	1-5 / 6-7 + 9-10	2x29,30	●		●
V54.18/27226	115	6	2666	1-5 / 7-9	7,53	●		●
V54.18/27227	115	9	1777	1-5 / 7-9	11,25	●		●
V54.18/27228	115	12	1333	1-5 / 7-9	14,95	●		●
V54.18/27229	115	15	1066	1-5 / 7-9	18,65	●		●
V54.18/27230	115	18	888	1-5 / 7-9	21,75	●		●
V54.18/27231	115	24	666	1-5 / 7-9	29,50	●		●
V54.18/27232	115	2x6	2x1333	1-5 / 6-7 + 9-10	2x7,53	●		●
V54.18/27233	115	2x9	2x888	1-5 / 6-7 + 9-10	2x11,20	●		●
V54.18/27234	115	2x12	2x666	1-5 / 6-7 + 9-10	2x14,90	●		●
V54.18/27235	115	2x15	2x533	1-5 / 6-7 + 9-10	2x18,40	●		●
V54.18/27236	115	2x18	2x444	1-5 / 6-7 + 9-10	2x22,30	●		●
V54.18/27237	115	2x24	2x333	1-5 / 6-7 + 9-10	2x29,30	●		●

Trenntransformator / isolation transformer

Typ/Type

EI54/18,8

Sicherheitstransformator
 VDE 0570 / EN 61558 / ENEC10
 UL 506 / CSA geprüft
 Vakuumverguss
 Temperaturklasse ta70°C/B
 Cul-Gewicht: 80 g
 Gesamt-Gewicht: 417 g

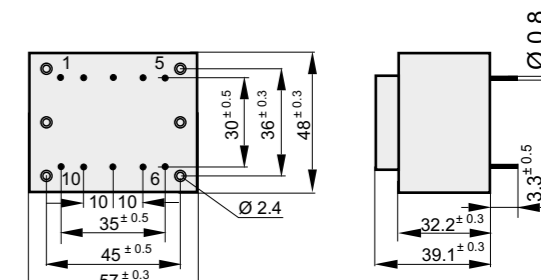

Ansicht auf Stiftseite - Pin view
 Abmessungen in mm - Dimensions in mm

Nennleistung/Nominal power

16.0 VA

Safety transformer
 VDE 0570 / EN 61558 / ENEC10
 UL 506 / CSA approved
 Vacuum casting
 Temperature class ta70°C/B
 Cul weight: 80 g
 Total weight: 417 g

Ausführung / version

BO

Raster / pitch

30 mm

Stifte / pinning

2 x 5



Bestell Nr. <i>Order No.</i>	Primär [V] <i>Primary</i>	Sekundär [V] <i>Secondary</i>	Strom [mA] <i>Current</i>	Stiftbelegung <i>Pin configuration</i>	Leerlaufspannung [V] <i>No load voltage</i>	Prüfzeichen / Approvals		
						VDE	5085-2/3	5085-1/2
V54.18/17238	230	6	2666	1-5 / 7-9	7,53	●		●
V54.18/17239	230	9	1777	1-5 / 7-9	11,25	●		●
V54.18/17240	230	12	1333	1-5 / 7-9	14,95	●		●
V54.18/17241	230	15	1066	1-5 / 7-9	18,65	●		●
V54.18/17242	230	18	888	1-5 / 7-9	21,75	●		●
V54.18/17243	230	24	666	1-5 / 7-9	29,50	●		●
V54.18/17244	230	2x6	2x1333	1-5 / 6-7 + 9-10	2x7,53	●		●
V54.18/17245	230	2x9	2x888	1-5 / 6-7 + 9-10	2x11,20	●		●
V54.18/17246	230	2x12	2x666	1-5 / 6-7 + 9-10	2x14,90	●		●
V54.18/17247	230	2x15	2x533	1-5 / 6-7 + 9-10	2x18,40	●		●
V54.18/17248	230	2x18	2x444	1-5 / 6-7 + 9-10	2x22,30	●		●
V54.18/17249	230	2x24	2x333	1-5 / 6-7 + 9-10	2x29,30	●		●
V54.18/27238	115	6	2666	1-5 / 7-9	7,53	●		●
V54.18/27239	115	9	1777	1-5 / 7-9	11,25	●		●
V54.18/27240	115	12	1333	1-5 / 7-9	14,95	●		●
V54.18/27241	115	15	1066	1-5 / 7-9	18,65	●		●
V54.18/27242	115	18	888	1-5 / 7-9	21,75	●		●
V54.18/27243	115	24	666	1-5 / 7-9	29,50	●		●
V54.18/27244	115	2x6	2x1333	1-5 / 6-7 + 9-10	2x7,53	●		●
V54.18/27245	115	2x9	2x888	1-5 / 6-7 + 9-10	2x11,20	●		●
V54.18/27246	115	2x12	2x666	1-5 / 6-7 + 9-10	2x14,90	●		●
V54.18/27247	115	2x15	2x533	1-5 / 6-7 + 9-10	2x18,40	●		●
V54.18/27248	115	2x18	2x444	1-5 / 6-7 + 9-10	2x22,30	●		●
V54.18/27249	115	2x24	2x333	1-5 / 6-7 + 9-10	2x29,30	●		●

Trenntransformator / isolation transformer

Typ/Type

EI54/18,8

Sicherheitstransformator
 VDE 0570 / EN 61558 / ENEC10
 UL 506 / CSA geprüft
 Vakuumverguss
 Temperaturklasse ta70°C/B
 Cul-Gewicht: 80 g
 Gesamt-Gewicht: 417 g

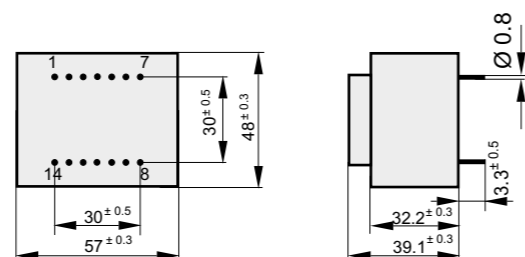

Ansicht auf Stiftseite - Pin view
 Abmessungen in mm - Dimensions in mm

Nennleistung/Nominal power

16.0 VA

Safety transformer
 VDE 0570 / EN 61558 / ENEC10
 UL 506 / CSA approved
 Vacuum casting
 Temperature class ta70°C/B
 Cul weight: 80 g
 Total weight: 417 g

Ausführung / version

0

Raster / pitch

30 mm

Stifte / pinning

2 x 7



Bestell Nr. <i>Order No.</i>	Primär [V] <i>Primary</i>	Sekundär [V] <i>Secondary</i>	Strom [mA] <i>Current</i>	Stiftbelegung <i>Pin configuration</i>	Leerlaufspannung [V] <i>No load voltage</i>	Prüfzeichen / Approvals		
						VDE	5085-2/3	5085-1/2

V54.18/17333	230	6	2666	1-7 / 9-13	7,53	●		●
V54.18/17334	230	9	1777	1-7 / 9-13	11,25	●		●
V54.18/17335	230	12	1333	1-7 / 9-13	14,95	●		●
V54.18/17336	230	15	1066	1-7 / 9-13	18,65	●		●
V54.18/17337	230	18	888	1-7 / 9-13	21,75	●		●
V54.18/17338	230	24	666	1-7 / 9-13	29,50	●		●
V54.18/17339	230	2x6	2x1333	1-7 / 8-9 + 13-14	2x7,53	●		●
V54.18/17340	230	2x7,5	2x1066	1-7 / 8-9 + 13-14	2x9,35	●		●
V54.18/17341	230	2x9	2x888	1-7 / 8-9 + 13-14	2x11,20	●		●
V54.18/17342	230	2x12	2x666	1-7 / 8-9 + 13-14	2x14,90	●		●
V54.18/17343	230	2x15	2x533	1-7 / 8-9 + 13-14	2x18,40	●		●
V54.18/17344	230	2x18	2x444	1-7 / 8-9 + 13-14	2x22,30	●		●
V54.18/17345	230	2x24	2x333	1-7 / 8-9 + 13-14	2x29,30	●		●

V54.18/27313	115	6	2666	1-7 / 9-13	7,53	●		●
V54.18/27314	115	9	1777	1-7 / 9-13	11,25	●		●
V54.18/27315	115	12	1333	1-7 / 9-13	14,95	●		●
V54.18/27316	115	15	1066	1-7 / 9-13	18,65	●		●
V54.18/27317	115	18	888	1-7 / 9-13	21,75	●		●
V54.18/27318	115	24	666	1-7 / 9-13	29,50	●		●
V54.18/27319	115	2x6	2x1333	1-7 / 8-9 + 13-14	2x7,53	●		●
V54.18/27320	115	2x7,5	2x1066	1-7 / 8-9 + 13-14	2x9,35	●		●
V54.18/27321	115	2x9	2x888	1-7 / 8-9 + 13-14	2x11,20	●		●
V54.18/27322	115	2x12	2x666	1-7 / 8-9 + 13-14	2x14,90	●		●
V54.18/27323	115	2x15	2x533	1-7 / 8-9 + 13-14	2x18,40	●		●
V54.18/27324	115	2x18	2x444	1-7 / 8-9 + 13-14	2x22,30	●		●
V54.18/27325	115	2x24	2x333	1-7 / 8-9 + 13-14	2x29,30	●		●

Trenntransformator / isolation transformer

Typ/Type

EI54/18,8

Sicherheitstransformator
 VDE 0570 / EN 61558 / ENEC10
 UL 506 / CSA geprüft
 Vakuumverguss
 Temperaturklasse ta70°C/B
 Cul-Gewicht: 80 g
 Gesamt-Gewicht: 417 g

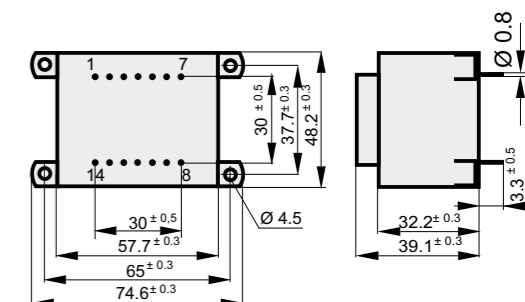

Ansicht auf Stiftseite - Pin view
 Abmessungen in mm - Dimensions in mm

Nennleistung/Nominal power

16.0 VA

Safety transformer
 VDE 0570 / EN 61558 / ENEC10
 UL 506 / CSA approved
 Vacuum casting
 Temperature class ta70°C/B
 Cul weight: 80 g
 Total weight: 417 g

Ausführung / version

KK

Raster / pitch

30 mm

Stifte / pinning

2 x 7



Bestell Nr. <i>Order No.</i>	Primär [V] <i>Primary</i>	Sekundär [V] <i>Secondary</i>	Strom [mA] <i>Current</i>	Stiftbelegung <i>Pin configuration</i>	Leerlaufspannung [V] <i>No load voltage</i>	Prüfzeichen / Approvals		
						VDE	5085-2/3	5085-1/2

V54.18/17300	230	6	2666	1-7 / 9-13	7,53	●		●
V54.18/17301	230	9	1777	1-7 / 9-13	11,25	●		●
V54.18/17302	230	12	1333	1-7 / 9-13	14,95	●		●
V54.18/17303	230	15	1066	1-7 / 9-13	18,65	●		●
V54.18/17304	230	18	888	1-7 / 9-13	21,75	●		●
V54.18/17305	230	24	666	1-7 / 9-13	29,50	●		●
V54.18/17306	230	2x6	2x1333	1-7 / 8-9 + 13-14	2x7,53	●		●
V54.18/17307	230	2x7,5	2x1066	1-7 / 8-9 + 13-14	2x9,35	●		●
V54.18/17308	230	2x9	2x888	1-7 / 8-9 + 13-14	2x11,20	●		●
V54.18/17309	230	2x12	2x666	1-7 / 8-9 + 13-14	2x14,90	●		●
V54.18/17310	230	2x15	2x533	1-7 / 8-9 + 13-14	2x18,40	●		●
V54.18/17311	230	2x18	2x444	1-7 / 8-9 + 13-14	2x22,30	●		●
V54.18/17312	230	2x24	2x333	1-7 / 8-9 + 13-14	2x29,30	●		●

V54.18/27300	115	6	2666	1-7 / 9-13	7,53	●		●
V54.18/27301	115	9	1777	1-7 / 9-13	11,25	●		●
V54.18/27302	115	12	1333	1-7 / 9-13	14,95	●		●
V54.18/27303	115	15	1066	1-7 / 9-13	18,65	●		●
V54.18/27304	115	18	888	1-7 / 9-13	21,75	●		●
V54.18/27305	115	24	666	1-7 / 9-13	29,50	●		●
V54.18/27306	115	2x6	2x1333	1-7 / 8-9 + 13-14	2x7,53	●		●
V54.18/27307	115	2x7,5	2x1066	1-7 / 8-9 + 13-14	2x9,35	●		●
V54.18/27308	115	2x9	2x888	1-7 / 8-9 + 13-14	2x11,20	●		●
V54.18/27309	115	2x12	2x666	1-7 / 8-9 + 13-14	2x14,90	●		●
V54.18/27310	115	2x15	2x533	1-7 / 8-9 + 13-14	2x18,40	●		●
V54.18/27311	115	2x18	2x444	1-7 / 8-9 + 13-14	2x22,30	●		●
V54.18/27312	115	2x24	2x333	1-7 / 8-9 + 13-14	2x29,30	●		●

Trenntransformator / isolation transformer

Typ/Type

EI54/18,8

Sicherheitstransformator
 VDE 0570 / EN 61558 / ENEC10
 UL 506 / CSA geprüft
 Vakuumverguss
 Temperaturklasse ta70°C/B
 Cul-Gewicht: 80 g
 Gesamt-Gewicht: 417 g

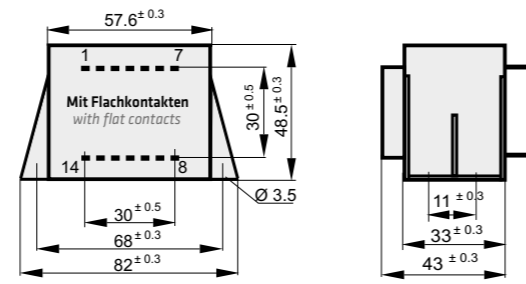

Ansicht auf Stiftseite - Pin view
 Abmessungen in mm - Dimensions in mm

Ausführung / version

VL

Nennleistung/Nominal power

16.0 VA

Safety transformer
 VDE 0570 / EN 61558 / ENEC10
 UL 506 / CSA approved
 Vacuum casting
 Temperature class ta70°C/B
 Cul weight: 80 g
 Total weight: 417 g



Bestell Nr. <i>Order No.</i>	Primär [V] <i>Primary</i>	Sekundär [V] <i>Secondary</i>	Strom [mA] <i>Current</i>	Stiftbelegung <i>Pin configuration</i>	Leerlaufspannung [V] <i>No load voltage</i>	Prüfzeichen / Approvals		
						VDE	5085-2/3	5085-1/2
V54.18/17346	230	6	2666	1-7 / 9-13	7,53	●		●
V54.18/17347	230	9	1777	1-7 / 9-13	11,25	●		●
V54.18/17348	230	12	1333	1-7 / 9-13	14,95	●		●
V54.18/17349	230	15	1066	1-7 / 9-13	18,65	●		●
V54.18/17350	230	18	888	1-7 / 9-13	21,75	●		●
V54.18/17351	230	24	666	1-7 / 9-13	29,50	●		●
V54.18/17352	230	2x6	2x1333	1-7 / 8-9 + 13-14	2x7,53	●		●
V54.18/17353	230	2x7,5	2x1066	1-7 / 8-9 + 13-14	2x9,35	●		●
V54.18/17354	230	2x9	2x888	1-7 / 8-9 + 13-14	2x11,20	●		●
V54.18/17355	230	2x12	2x666	1-7 / 8-9 + 13-14	2x14,90	●		●
V54.18/17356	230	2x15	2x533	1-7 / 8-9 + 13-14	2x18,40	●		●
V54.18/17357	230	2x18	2x444	1-7 / 8-9 + 13-14	2x22,30	●		●
V54.18/17358	230	2x24	2x333	1-7 / 8-9 + 13-14	2x29,30	●		●
V54.18/27326	115	6	2666	1-7 / 9-13	7,53	●		●
V54.18/27327	115	9	1777	1-7 / 9-13	11,25	●		●
V54.18/27328	115	12	1333	1-7 / 9-13	14,95	●		●
V54.18/27329	115	15	1066	1-7 / 9-13	18,65	●		●
V54.18/27330	115	18	888	1-7 / 9-13	21,75	●		●
V54.18/27331	115	24	666	1-7 / 9-13	29,50	●		●
V54.18/27332	115	2x6	2x1333	1-7 / 8-9 + 13-14	2x7,53	●		●
V54.18/27333	115	2x7,5	2x1066	1-7 / 8-9 + 13-14	2x9,35	●		●
V54.18/27334	115	2x9	2x888	1-7 / 8-9 + 13-14	2x11,20	●		●
V54.18/27335	115	2x12	2x666	1-7 / 8-9 + 13-14	2x14,90	●		●
V54.18/27336	115	2x15	2x533	1-7 / 8-9 + 13-14	2x18,40	●		●
V54.18/27337	115	2x18	2x444	1-7 / 8-9 + 13-14	2x22,30	●		●
V54.18/27338	115	2x24	2x333	1-7 / 8-9 + 13-14	2x29,30	●		●

Trenntransformator / isolation transformer

Typ/Type

EI54/18,8

Sicherheitstransformator
 VDE 0570 / EN 61558 / ENEC10
 UL 506 / CSA geprüft
 Vakuumverguss
 Temperaturklasse ta70°C/B
 Cul-Gewicht: 80 g
 Gesamt-Gewicht: 417 g

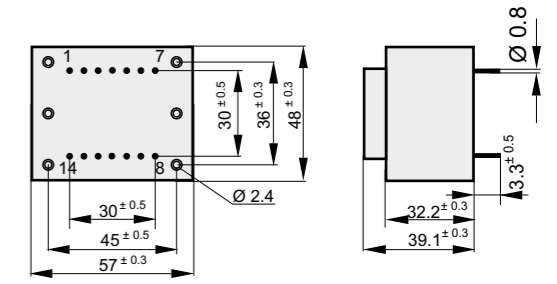

Ansicht auf Stiftseite - Pin view
 Abmessungen in mm - Dimensions in mm

Nennleistung/Nominal power

16.0 VA

Safety transformer
 VDE 0570 / EN 61558 / ENEC10
 UL 506 / CSA approved
 Vacuum casting
 Temperature class ta70°C/B
 Cul weight: 80 g
 Total weight: 417 g

Ausführung / version

B0

Raster / pitch

30 mm

Stifte / pinning

2 x 7



Bestell Nr. <i>Order No.</i>	Primär [V] <i>Primary</i>	Sekundär [V] <i>Secondary</i>	Strom [mA] <i>Current</i>	Stiftbelegung <i>Pin configuration</i>	Leerlaufspannung [V] <i>No load voltage</i>	Prüfzeichen / Approvals		
						VDE	5085-2/3	5085-1/2
V54.18/17359	230	6	2666	1-7 / 9-13	7,53	●		●
V54.18/17360	230	9	1777	1-7 / 9-13	11,25	●		●
V54.18/17361	230	12	1333	1-7 / 9-13	14,95	●		●
V54.18/17362	230	15	1066	1-7 / 9-13	18,65	●		●
V54.18/17363	230	18	888	1-7 / 9-13	21,75	●		●
V54.18/17364	230	24	666	1-7 / 9-13	29,50	●		●
V54.18/17365	230	2x6	2x1333	1-7 / 8-9 + 13-14	2x7,53	●		●
V54.18/17366	230	2x7,5	2x1066	1-7 / 8-9 + 13-14	2x9,35	●		●
V54.18/17367	230	2x9	2x888	1-7 / 8-9 + 13-14	2x11,20	●		●
V54.18/17368	230	2x12	2x666	1-7 / 8-9 + 13-14	2x14,90	●		●
V54.18/17369	230	2x15	2x533	1-7 / 8-9 + 13-14	2x18,40	●		●
V54.18/17370	230	2x18	2x444	1-7 / 8-9 + 13-14	2x22,30	●		●
V54.18/17371	230	2x24	2x333	1-7 / 8-9 + 13-14	2x29,30	●		●
V54.18/27339	115	6	2666	1-7 / 9-13	7,53	●		●
V54.18/27340	115	9	1777	1-7 / 9-13	11,25	●		●
V54.18/27341	115	12	1333	1-7 / 9-13	14,95	●		●
V54.18/27342	115	15	1066	1-7 / 9-13	18,65	●		●
V54.18/27343	115	18	888	1-7 / 9-13	21,75	●		●
V54.18/27344	115	24	666	1-7 / 9-13	29,50	●		●
V54.18/27345	115	2x6	2x1333	1-7 / 8-9 + 13-14	2x7,53	●		●
V54.18/27346	115	2x7,5	2x1066	1-7 / 8-9 + 13-14	2x9,35	●		●
V54.18/27347	115	2x9	2x888	1-7 / 8-9 + 13-14	2x11,20	●		●
V54.18/27348	115	2x12	2x666	1-7 / 8-9 + 13-14	2x14,90	●		●
V54.18/27349	115	2x15	2x533	1-7 / 8-9 + 13-14	2x18,40	●		●
V54.18/27350	115	2x18	2x444	1-7 / 8-9 + 13-14	2x22,30	●		●
V54.18/27351	115	2x24	2x333	1-7 / 8-9 + 13-14	2x29,30	●		●

Trenntransformator / isolation transformer

Typ/Type

EI54/23

Sicherheitstransformator
 VDE 0570 / EN 61558 / ENEC10 geprüft
 Vakuumverguss
 Temperaturklasse ta70°C/B
 Cul-Gewicht: 90 g
 Gesamt-Gewicht: 500 g

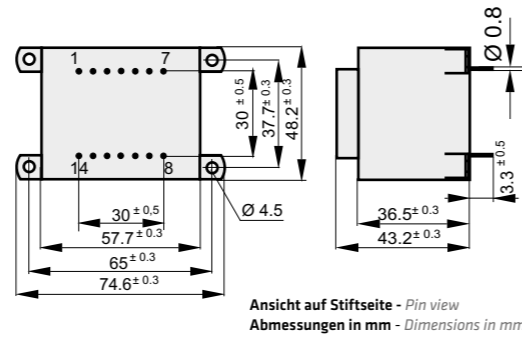

Ausführung / version

KK

Raster / pitch

30 mm

Stifte / pinning

2 x 7



Nennleistung/Nominal power

20.0 VA

Safety transformer
 VDE 0570 / EN 61558 / ENEC10 approved
 Vacuum casting
 Temperature class ta70°C/B
 Cul weight: 90 g
 Total weight: 500 g

Bestell Nr. <i>Order No.</i>	Primär [V] <i>Primary</i>	Sekundär [V] <i>Secondary</i>	Strom [mA] <i>Current</i>	Stiftbelegung <i>Pin configuration</i>	Leerlaufspannung [V] <i>No load voltage</i>	Prüfzeichen / Approvals		
						VDE	5085-2/3	5085-1/2
V54.23/17507	230	6	3333	1-7 / 9-13	7,55	●		
V54.23/17508	230	9	2222	1-7 / 9-13	11,10	●		
V54.23/17509	230	12	1666	1-7 / 9-13	14,45	●		
V54.23/17510	230	15	1333	1-7 / 9-13	17,85	●		
V54.23/17511	230	18	1111	1-7 / 9-13	21,25	●		
V54.23/17512	230	24	833	1-7 / 9-13	28,80	●		
V54.23/17513	230	2x6	2x1666	1-7 / 8-9 + 13-14	2x7,65	●		
V54.23/17514	230	2x9	2x1111	1-7 / 8-9 + 13-14	2x11,10	●		
V54.23/17515	230	2x12	2x833	1-7 / 8-9 + 13-14	2x14,50	●		
V54.23/17516	230	2x15	2x666	1-7 / 8-9 + 13-14	2x18,05	●		
V54.23/17517	230	2x18	2x555	1-7 / 8-9 + 13-14	2x21,25	●		

Typ/Type

EI54/23

Sicherheitstransformator
 VDE 0570 / EN 61558 / ENEC10 geprüft
 Vakuumverguss
 Temperaturklasse ta70°C/B
 Cul-Gewicht: 90 g
 Gesamt-Gewicht: 500 g

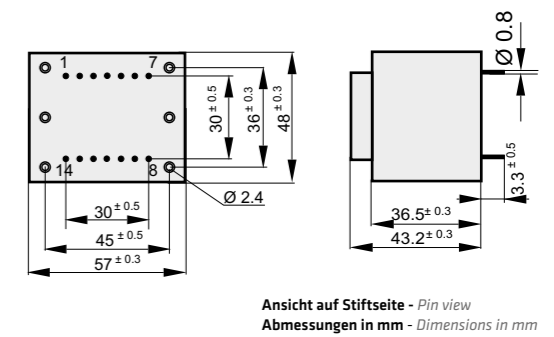

Nennleistung/Nominal power

20.0 VA

Safety transformer
 VDE 0570 / EN 61558 / ENEC10 approved
 Vacuum casting
 Temperature class ta70°C/B
 Cul weight: 90 g
 Total weight: 500 g

Ausführung / version

BO

Raster / pitch

30 mm

Stifte / pinning

2 x 7



Bestell Nr. <i>Order No.</i>	Primär [V] <i>Primary</i>	Sekundär [V] <i>Secondary</i>	Strom [mA] <i>Current</i>	Stiftbelegung <i>Pin configuration</i>	Leerlaufspannung [V] <i>No load voltage</i>	Prüfzeichen / Approvals		
						VDE	5085-2/3	5085-1/2
V54.23/17530	230	6	3333	1-7 / 9-13	7,55	●		
V54.23/17531	230	9	2222	1-7 / 9-13	11,10	●		
V54.23/17532	230	12	1666	1-7 / 9-13	14,45	●		
V54.23/17533	230	15	1333	1-7 / 9-13	17,85	●		
V54.23/17534	230	18	1111	1-7 / 9-13	21,25	●		
V54.23/17535	230	24	833	1-7 / 9-13	28,80	●		
V54.23/17536	230	2x6	2x1666	1-7 / 8-9 + 13-14	2x7,65	●		
V54.23/17537	230	2x9	2x1111	1-7 / 8-9 + 13-14	2x11,10	●		
V54.23/17538	230	2x12	2x833	1-7 / 8-9 + 13-14	2x14,50	●		
V54.23/17539	230	2x15	2x666	1-7 / 8-9 + 13-14	2x18,05	●		
V54.23/17540	230	2x18	2x555	1-7 / 8-9 + 13-14	2x21,25	●		

Typ/Type

EI54/25,5

Sicherheitstransformator
 VDE 0570 / EN 61558 / ENEC10 geprüft
 Vakuumverguss
 Temperaturklasse ta70°C/B
 Cul-Gewicht: 100 g
 Gesamt-Gewicht: 580 g

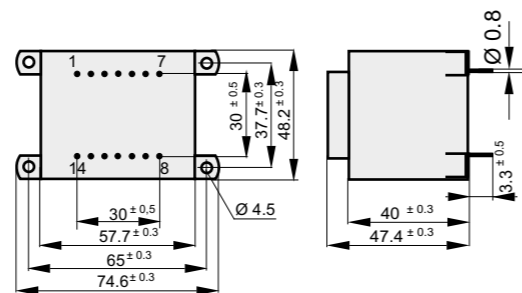

Ansicht auf Stiftseite - Pin view
 Abmessungen in mm - Dimensions in mm

Nennleistung/Nominal power

23.0 VA

Safety transformer
 VDE 0570 / EN 61558 / ENEC10 approved
 Vacuum casting
 Temperature class ta70°C/B
 Cul weight: 100 g
 Total weight: 580 g

Ausführung / version

KK

Raster / pitch

30 mm

Stifte / pinning

2 x 7



Bestell Nr. <i>Order No.</i>	Primär [V] <i>Primary</i>	Sekundär [V] <i>Secondary</i>	Strom [mA] <i>Current</i>	Stiftbelegung <i>Pin configuration</i>	Leerlaufspannung [V] <i>No load voltage</i>	Prüfzeichen / Approvals		
						VDE	5085-2/3	5085-1/2
V54.25/17518	230	6	3833	1-7 / 9-13	7,60	●		
V54.25/17519	230	9	2555	1-7 / 9-13	11,15	●		
V54.25/17520	230	12	1916	1-7 / 9-13	14,55	●		
V54.25/17521	230	15	1533	1-7 / 9-13	18,10	●		
V54.25/17522	230	18	1277	1-7 / 9-13	21,60	●		
V54.25/17523	230	24	958	1-7 / 9-13	28,30	●		
V54.25/17524	230	2x6	2x1916	1-7 / 8-9 + 13-14	2x7,60	●		
V54.25/17525	230	2x9	2x1277	1-7 / 8-9 + 13-14	2x11,15	●		
V54.25/17526	230	2x12	2x958	1-7 / 8-9 + 13-14	2x14,65	●		
V54.25/17527	230	2x15	2x766	1-7 / 8-9 + 13-14	2x18,15	●		
V54.25/17528	230	2x18	2x638	1-7 / 8-9 + 13-14	2x21,10	●		



Entscheidende Vorteile unserer EI60 - EI96-Transformatoren:

- kompakte Bauweise mit einem Leistungsbereich bis 220 VA
- optimale Bauhöhe für den Einsatz auf Leiterplatten
- nicht oder bedingt kurzschlussfest mit interner Temperatursicherung
- ausgezeichnetes Temperaturwechselverhalten durch Vakuumverguss
- Absicherung extern durch PTC möglich
- 100% stückgeprüft mit 4000 V PRI-SEC
- Temperatur-/Isolierstoffklasse ta 40°C/B, ta 70°C/B
- höchste Sicherheit und Langlebigkeit
- VDE-, UL-, CSA-, ENEC10-Prüfzeichen
- fester Sitz auf der Leiterplatte durch zusätzliche Befestigungsmöglichkeiten
- Zweikammer-Wicklung
- hohe Stoßspannungsfestigkeit
- selbstverlöschendes Haubenmaterial

Key advantages of our EI60 - EI96-transformers:

- compact design with power range up to 220
- optimal height for installation on PCB boards
- non short circuit proof or conditionally short circuit proof with internal thermal fuse
- excellent temperature-change behavior owing to vacuum casting
- secondary protection by means of external PTC resistances possible
- 100% unit checked with 4000 V PRI-SEC
- ambient temperature insulation class ta 40°C/B, ta 70°C/B
- highest safety and lifetime
- VDE, UL, CSA, ENEC10 approvals
- snug fit on PCB through additional fixing
- split bobbin, two chamber winding
- high surge capability
- self-extinguishing case material

Sämtliche Baugrößen können wir nach Kundenwunsch anpassen:

- weitere PRI-SEC-Spannungen
- individuelle Leistungen
- unvergossene Ausführungen
- spezielle PIN-Belegung
- höhere Temperaturklassen
- eingebaute Thermosicherung/-schalter möglich
- weitere Gehäuse-/Anschluss-/Befestigungsmöglichkeiten
- raumsparende Montage durch innenliegende Befestigungsleiste

Customization of all sizes is possible:

- further PRI-SEC voltages
- individual power values
- unpotted versions
- special PIN configurations
- higher temperature classes
- installed thermal fuse/thermal switch optionally available
- further case/connection/fixing options
- space-saving installation through inside fastening rail

Typ <i>Type</i>	Abmessungen (B x T x H) [mm] <i>Dimensions (L x W x H)</i>	Leistung bei ta 70°C/B [VA] <i>Power at ta 70°C/B</i>
EI60/21	66.0 x 56.0 x 47.0	24.0
EI60/25,5	66.0 x 56.0 x 51.2	28.0
EI60/30,5	66.0 x 56.0 x 56.5	32.0
EI60/35	66.0 x 56.0 x 61.0	35.0 NEU/NEW
EI66/23	70.6 x 59.5 x 49.0	34.0
EI66/30	70.6 x 59.5 x 56.0	45.0
EI66/34,7	70.6 x 60.5 x 60.4	50.0
EI66/40	70.6 x 59.5 x 65.3	52.0
EI78/27,5	81.8 x 71.0 x 59.7	55.0
EI78/36,5	81.8 x 71.0 x 68.2	65.0
EI78/40,5	81.8 x 71.0 x 71.3	80.0
EI84/29,5	89.9 x 77.0 x 63.5	75.0
EI84/43,5	89.9 x 77.0 x 76.5	100.0
EI96/35,7	129.5 x 87.6 x 74.6	140.0
EI96/45,7	129.5 x 87.6 x 84.4	180.0*
EI96/59,7	129.5 x 87.6 x 99.0	220.0*

* bei ta 40°C/B

* at ta 40°C/B

Typ/Type

EI60/21

Sicherheitstransformator
 VDE 0570 / EN 61558 / ENEC10
 UL 506 / CSA geprüft
 Vakuumverguss
 Temperaturklasse ta70°C/B
 Cul-Gewicht: 110 g
 Gesamt-Gewicht: 570 g

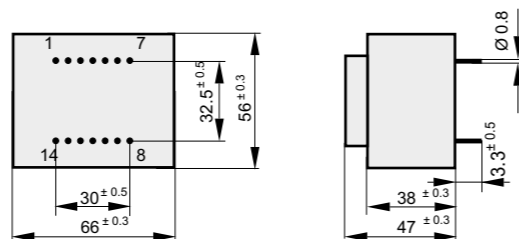

Ansicht auf Stiftseite - Pin view
 Abmessungen in mm - Dimensions in mm

Nennleistung/Nominal power

24 VA

Safety transformer
 VDE 0570 / EN 61558 / ENEC10
 UL 506 / CSA approved
 Vacuum casting
 Temperature class ta70°C/B
 Cul weight: 110 g
 Total weight: 570 g

Ausführung / version

0

Raster / pitch **32.5 mm** Stifte / pinning **2 x 7**



Bestell Nr. <i>Order No.</i>	Primär [V] <i>Primary</i>	Sekundär [V] <i>Secondary</i>	Strom [A] <i>Current</i>	Stiftbelegung <i>Pin configuration</i>	Leerlaufspannung [V] <i>No load voltage</i>	Prüfzeichen / Approvals		
						VDE	5085-2/3	5085-1/2

V60.21/18220	230	6	4,00	1-7 / 9-13	7,30	●		●
V60.21/18221	230	9	2,67	1-7 / 9-13	10,80	●		●
V60.21/18222	230	12	2,00	1-7 / 9-13	14,40	●		●
V60.21/18223	230	15	1,60	1-7 / 9-13	18,10	●		●
V60.21/18224	230	18	1,33	1-7 / 9-13	21,40	●		●
V60.21/18225	230	24	1,00	1-7 / 9-13	28,70	●		●
V60.21/18226	230	2x6	2x2,00	1-7 / 8-9 + 13-14	2x7,30	●		●
V60.21/18227	230	2x7,5	2x1,60	1-7 / 8-9 + 13-14	2x9,10	●		●
V60.21/18228	230	2x9	2x1,33	1-7 / 8-9 + 13-14	2x10,80	●		●
V60.21/18229	230	2x12	2x1,00	1-7 / 8-9 + 13-14	2x14,40	●		●
V60.21/18230	230	2x15	2x0,80	1-7 / 8-9 + 13-14	2x18,10	●		●
V60.21/18231	230	2x18	2x0,67	1-7 / 8-9 + 13-14	2x21,40	●		●
V60.21/18232	230	2x24	2x0,50	1-7 / 8-9 + 13-14	2x29,00	●		●

Trenntransformator / isolation transformer

Typ/Type

EI60/21

Sicherheitstransformator
 VDE 0570 / EN 61558 / ENEC10
 UL 506 / CSA geprüft
 Vakuumverguss
 Temperaturklasse ta70°C/B
 Cul-Gewicht: 110 g
 Gesamt-Gewicht: 570 g

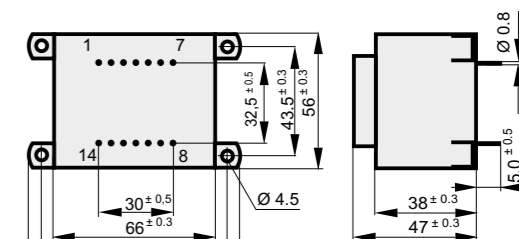

Ansicht auf Stiftseite - Pin view
 Abmessungen in mm - Dimensions in mm

Nennleistung/Nominal power

24 VA

Safety transformer
 VDE 0570 / EN 61558 / ENEC10
 UL 506 / CSA approved
 Vacuum casting
 Temperature class ta70°C/B
 Cul weight: 110 g
 Total weight: 570 g

Ausführung / version

KK

Raster / pitch **32.5 mm** Stifte / pinning **2 x 7**



Bestell Nr. <i>Order No.</i>	Primär [V] <i>Primary</i>	Sekundär [V] <i>Secondary</i>	Strom [A] <i>Current</i>	Stiftbelegung <i>Pin configuration</i>	Leerlaufspannung [V] <i>No load voltage</i>	Prüfzeichen / Approvals		
						VDE	5085-2/3	5085-1/2

V60.21/18384	230	6	4,00	1-7 / 9-13	7,30	●		●
V60.21/18385	230	9	2,67	1-7 / 9-13	10,80	●		●
V60.21/18386	230	12	2,00	1-7 / 9-13	14,40	●		●
V60.21/18387	230	15	1,60	1-7 / 9-13	18,10	●		●
V60.21/18388	230	18	1,33	1-7 / 9-13	21,40	●		●
V60.21/18389	230	24	1,00	1-7 / 9-13	28,70	●		●
V60.21/18390	230	2x6	2x2,00	1-7 / 8-9 + 13-14	2x7,30	●		●
V60.21/18391	230	2x7,5	2x1,60	1-7 / 8-9 + 13-14	2x9,10	●		●
V60.21/18392	230	2x9	2x1,33	1-7 / 8-9 + 13-14	2x10,80	●		●
V60.21/18393	230	2x12	2x1,00	1-7 / 8-9 + 13-14	2x14,40	●		●
V60.21/18394	230	2x15	2x0,80	1-7 / 8-9 + 13-14	2x18,10	●		●
V60.21/18395	230	2x18	2x0,67	1-7 / 8-9 + 13-14	2x21,40	●		●
V60.21/18396	230	2x24	2x0,50	1-7 / 8-9 + 13-14	2x29,00	●		●

Trenntransformator / isolation transformer

Typ/Type

EI60/21

Sicherheitstransformator
VDE 0570 / EN 61558 / ENEC10
UL 506 / CSA geprüft
Vakuumverguss
Temperaturklasse ta70°C/B
Cul-Gewicht: 110 g
Gesamt-Gewicht: 570 g

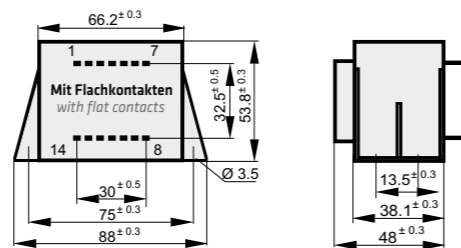

Ansicht auf Stiftseite - Pin view
Abmessungen in mm - Dimensions in mm

Nennleistung/Nominal power

24 VA

Safety transformer
VDE 0570 / EN 61558 / ENEC10
UL 506 / CSA approved
Vacuum casting
Temperature class ta70°C/B
Cul weight: 110 g
Total weight: 570 g

Ausführung / version

VL



Bestell Nr. <i>Order No.</i>	Primär [V] <i>Primary</i>	Sekundär [V] <i>Secondary</i>	Strom [A] <i>Current</i>	Stiftbelegung <i>Pin configuration</i>	Leerlaufspannung [V] <i>No load voltage</i>	Prüfzeichen / Approvals		
						VDE	5085-2/3	5085-1/2
V60.21/18233	230	6	4,00	1-7 / 9-13	7,30	●		●
V60.21/18234	230	9	2,67	1-7 / 9-13	10,80	●		●
V60.21/18235	230	12	2,00	1-7 / 9-13	14,40	●		●
V60.21/18236	230	15	1,60	1-7 / 9-13	18,10	●		●
V60.21/18237	230	18	1,33	1-7 / 9-13	21,40	●		●
V60.21/18238	230	24	1,00	1-7 / 9-13	28,70	●		●
V60.21/18239	230	2x6	2x2,00	1-7 / 8-9 + 13-14	2x7,30	●		●
V60.21/18240	230	2x7,5	2x1,60	1-7 / 8-9 + 13-14	2x9,10	●		●
V60.21/18241	230	2x9	2x1,33	1-7 / 8-9 + 13-14	2x10,80	●		●
V60.21/18242	230	2x12	2x1,00	1-7 / 8-9 + 13-14	2x14,40	●		●
V60.21/18243	230	2x15	2x0,80	1-7 / 8-9 + 13-14	2x18,10	●		●
V60.21/18244	230	2x18	2x0,67	1-7 / 8-9 + 13-14	2x21,40	●		●
V60.21/18245	230	2x24	2x0,50	1-7 / 8-9 + 13-14	2x29,00	●		●

Trenntransformator / isolation transformer

Typ/Type

EI60/21

Sicherheitstransformator
VDE 0570 / EN 61558 / ENEC10
UL 506 / CSA geprüft
Vakuumverguss
Temperaturklasse ta70°C/B
Cul-Gewicht: 110 g
Gesamt-Gewicht: 570 g

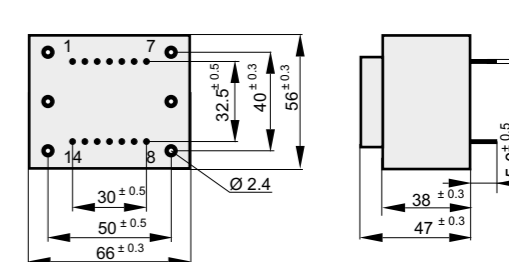

Ansicht auf Stiftseite - Pin view
Abmessungen in mm - Dimensions in mm

Nennleistung/Nominal power

24 VA

Safety transformer
VDE 0570 / EN 61558 / ENEC10
UL 506 / CSA approved
Vacuum casting
Temperature class ta70°C/B
Cul weight: 110 g
Total weight: 570 g

Ausführung / version

BO

Raster / pitch

32.5 mm

Stifte / pinning

2 x 7



Bestell Nr. <i>Order No.</i>	Primär [V] <i>Primary</i>	Sekundär [V] <i>Secondary</i>	Strom [A] <i>Current</i>	Stiftbelegung <i>Pin configuration</i>	Leerlaufspannung [V] <i>No load voltage</i>	Prüfzeichen / Approvals		
						VDE	5085-2/3	5085-1/2
V60.21/18246	230	6	4,00	1-7 / 9-13	7,30	●		●
V60.21/18247	230	9	2,67	1-7 / 9-13	10,80	●		●
V60.21/18248	230	12	2,00	1-7 / 9-13	14,40	●		●
V60.21/18249	230	15	1,60	1-7 / 9-13	18,10	●		●
V60.21/18250	230	18	1,33	1-7 / 9-13	21,40	●		●
V60.21/18251	230	24	1,00	1-7 / 9-13	28,70	●		●
V60.21/18252	230	2x6	2x2,00	1-7 / 8-9 + 13-14	2x7,30	●		●
V60.21/18253	230	2x7,5	2x1,60	1-7 / 8-9 + 13-14	2x9,10	●		●
V60.21/18254	230	2x9	2x1,33	1-7 / 8-9 + 13-14	2x10,80	●		●
V60.21/18255	230	2x12	2x1,00	1-7 / 8-9 + 13-14	2x14,40	●		●
V60.21/18256	230	2x15	2x0,80	1-7 / 8-9 + 13-14	2x18,10	●		●
V60.21/18257	230	2x18	2x0,67	1-7 / 8-9 + 13-14	2x21,40	●		●
V60.21/18258	230	2x24	2x0,50	1-7 / 8-9 + 13-14	2x29,00	●		●

Trenntransformator / isolation transformer

Typ/Type

EI60/25,5

Sicherheitstransformator
VDE 0570 / EN 61558 / ENEC10
UL 506 / CSA geprüft
Vakuummverguss
Temperaturklasse ta70°C/B
Cul-Gewicht: 120 g
Gesamt-Gewicht: 670 g

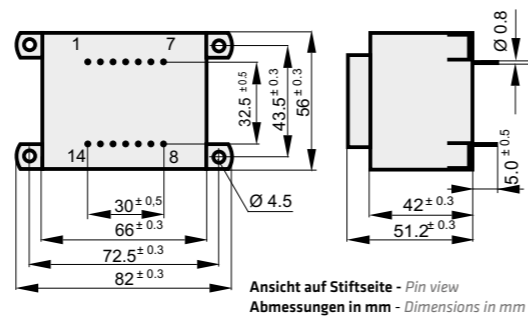

Ausführung / version

KK

Raster / pitch

32.5 mm 2 x 7

Stifte / pinning



Nennleistung/Nominal power

28 VA

Safety transformer
VDE 0570 / EN 61558 / ENEC10
UL 506 / CSA approved
Vacuum casting
Temperature class ta70°C/B
Cul weight: 120 g
Total weight: 670 g

Bestell Nr. <i>Order No.</i>	Primär [V] <i>Primary</i>	Sekundär [V] <i>Secondary</i>	Strom [A] <i>Current</i>	Stiftbelegung <i>Pin configuration</i>	Leerlaufspannung [V] <i>No load voltage</i>	Prüfzeichen / Approvals		
						VDE	5085-2/3	5085-1/2
V60.25/18259	230	6	4,67	1-7 / 9-13	7,30	●		●
V60.25/18260	230	9	3,11	1-7 / 9-13	10,88	●		●
V60.25/18261	230	12	2,33	1-7 / 9-13	14,29	●		●
V60.25/18262	230	15	1,87	1-7 / 9-13	17,88	●		●
V60.25/18263	230	18	1,56	1-7 / 9-13	21,46	●		●
V60.25/18264	230	24	1,17	1-7 / 9-13	28,60	●		●
V60.25/18265	230	2x6	2x2,33	1-7 / 8-9 + 13-14	2x7,30	●		●
V60.25/18266	230	2x7,5	2x1,87	1-7 / 8-9 + 13-14	2x8,85	●		●
V60.25/18267	230	2x9	2x1,56	1-7 / 8-9 + 13-14	2x10,57	●		●
V60.25/18268	230	2x12	2x1,67	1-7 / 8-9 + 13-14	2x14,05	●		●
V60.25/18269	230	2x15	2x0,93	1-7 / 8-9 + 13-14	2x17,45	●		●
V60.25/18270	230	2x18	2x0,78	1-7 / 8-9 + 13-14	2x21,15	●		●
V60.25/18271	230	2x24	2x0,58	1-7 / 8-9 + 13-14	2x28,61	●		●

Trenntransformator / isolation transformer

Typ/Type

EI60/30,5

Sicherheitstransformator
VDE 0570 / EN 61558 / ENEC10
UL 506 / CSA geprüft
Vakuummverguss
Temperaturklasse ta70°C/B
Cul-Gewicht: 135 g
Gesamt-Gewicht: 780 g

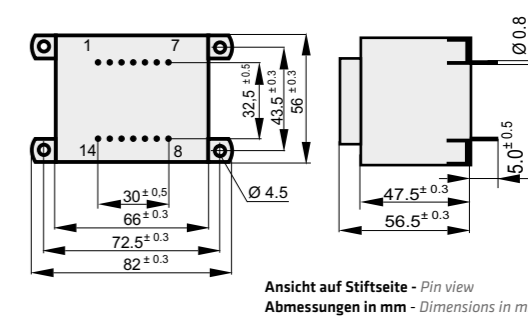

Nennleistung/Nominal power

32 VA

Safety transformer
VDE 0570 / EN 61558 / ENEC10
UL 506 / CSA approved
Vacuum casting
Temperature class ta70°C/B
Cul weight: 135 g
Total weight: 780 g

Ausführung / version

KK

Raster / pitch

32.5 mm 2 x 7

Stifte / pinning



Bestell Nr. <i>Order No.</i>	Primär [V] <i>Primary</i>	Sekundär [V] <i>Secondary</i>	Strom [A] <i>Current</i>	Stiftbelegung <i>Pin configuration</i>	Leerlaufspannung [V] <i>No load voltage</i>	Prüfzeichen / Approvals		
						VDE	5085-2/3	5085-1/2
V60.30/18311	230	6	5,33	1-7 / 9-13	7,18	●		●
V60.30/18312	230	9	3,56	1-7 / 9-13	10,46	●		●
V60.30/18313	230	12	2,67	1-7 / 9-13	13,90	●		●
V60.30/18314	230	15	2,13	1-7 / 9-13	17,20	●		●
V60.30/18315	230	18	1,78	1-7 / 9-13	20,60	●		●
V60.30/18316	230	24	1,33	1-7 / 9-13	27,17	●		●
V60.30/18317	230	2x6	2x2,67	1-7 / 8-9 + 13-14	2x7,15	●		●
V60.30/18318	230	2x7,5	2x2,13	1-7 / 8-9 + 13-14	2x8,55	●		●
V60.30/18319	230	2x9	2x1,78	1-7 / 8-9 + 13-14	2x10,20	●		●
V60.30/18320	230	2x12	2x1,33	1-7 / 8-9 + 13-14	2x13,65	●		●
V60.30/18321	230	2x15	2x1,07	1-7 / 8-9 + 13-14	2x17,12	●		●
V60.30/18322	230	2x18	2x0,89	1-7 / 8-9 + 13-14	2x20,18	●		●
V60.30/18323	230	2x24	2x0,67	1-7 / 8-9 + 13-14	2x27,15	●		●

Trenntransformator / isolation transformer

Typ/Type

EI60/35

Sicherheitstransformator
nach VDE 0570 / EN 61558
Vakuumverguss
Temperaturklasse ta70°C/B
Cul-Gewicht: 125 g
Gesamt-Gewicht: 860 g

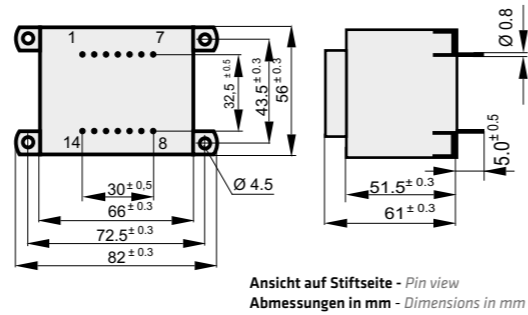

Nennleistung/Nominal power

35 VA

Safety transformer
according to VDE 0570 / EN 61558
Vacuum casting
Temperature class ta70°C/B
Cul weight: 125 g
Total weight: 860 g

Ausführung / version

KK

Raster / pitch

32.5 mm 2 x 7

Stifte / pinning



Bestell Nr. <i>Order No.</i>	Primär [V] <i>Primary</i>	Sekundär [V] <i>Secondary</i>	Strom [A] <i>Current</i>	Stiftbelegung <i>Pin configuration</i>	Leerlaufspannung [V] <i>No load voltage</i>	Prüfzeichen / Approvals		
						VDE	5085-2/3	5085-1/2
V60.35/18364	230	6	5,83	1-7 / 9-13	6,80			
V60.35/18365	230	9	3,89	1-7 / 9-13	10,40			
V60.35/18366	230	12	2,92	1-7 / 9-13	13,45			
V60.35/18377	230	15	2,33	1-7 / 9-13	16,80			
V60.35/18378	230	18	1,94	1-7 / 9-13	20,50			
V60.35/18363	230	24	1,46	1-7 / 9-13	27,30			
V60.35/18379	230	2x6	2x2,92	1-7 / 8-9 + 13-14	2x6,75			
V60.35/18380	230	2x9	2x1,94	1-7 / 8-9 + 13-14	2x10,30			
V60.35/18381	230	2x12	2x1,46	1-7 / 8-9 + 13-14	2x13,55			
V60.35/18382	230	2x15	2x1,17	1-7 / 8-9 + 13-14	2x16,80			
V60.35/18383	230	2x18	2x0,97	1-7 / 8-9 + 13-14	2x20,25			

Typ/Type

EI66/23

Sicherheitstransformator
VDE 0570 / EN 61558 / ENEC10
UL 506 / CSA geprüft
Vakuumverguss
Temperaturklasse ta70°C/B
Cul-Gewicht: 140 g
Gesamt-Gewicht: 765 g

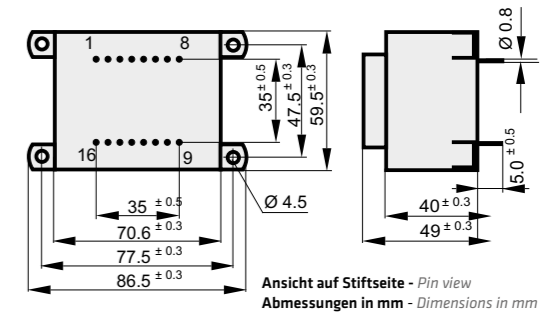

Nennleistung/Nominal power

34 VA

Safety transformer
VDE 0570 / EN 61558 / ENEC10
UL 506 / CSA approved
Vacuum casting
Temperature class ta70°C/B
Cul weight: 140 g
Total weight: 765 g

Ausführung / version

KK

Raster / pitch

35 mm 2 x 8

Stifte / pinning



Bestell Nr. <i>Order No.</i>	Primär [V] <i>Primary</i>	Sekundär [V] <i>Secondary</i>	Strom [A] <i>Current</i>	Stiftbelegung <i>Pin configuration</i>	Leerlaufspannung [V] <i>No load voltage</i>	Prüfzeichen / Approvals		
						VDE	5085-2/3	5085-1/2
V66.23/19200	230	6	5,67	1-8 / 11-14	7,00	●		●
V66.23/19201	230	9	3,78	1-8 / 11-14	10,30	●		●
V66.23/19202	230	12	2,83	1-8 / 11-14	13,80	●		●
V66.23/19203	230	15	2,27	1-8 / 11-14	17,30	●		●
V66.23/19204	230	18	1,89	1-8 / 11-14	20,80	●		●
V66.23/19205	230	24	1,42	1-8 / 11-14	27,70	●		●
V66.23/19207	230	2x6	2x2,83	1-8 / 9-10 + 15-16	2x6,90	●		●
V66.23/19208	230	2x7,5	2x2,27	1-8 / 9-10 + 15-16	2x8,60	●		●
V66.23/19209	230	2x9	2x1,89	1-8 / 9-10 + 15-16	2x10,50	●		●
V66.23/19230	230	2x12	2x1,42	1-8 / 9-10 + 15-16	2x14,00	●		●
V66.23/19231	230	2x15	2x1,13	1-8 / 9-10 + 15-16	2x17,40	●		●
V66.23/19232	230	2x18	2x0,94	1-8 / 9-10 + 15-16	2x20,90	●		●
V66.23/19233	230	2x24	2x0,71	1-8 / 9-10 + 15-16	2x27,70	●		●

Trenntransformator / isolation transformer

Typ/Type

EI66/30

Sicherheitstransformator
 VDE 0570 / EN 61558 / ENEC10
 UL 506 / CSA geprüft
 Vakuumverguss
 Temperaturklasse ta70°C/B
 Cul-Gewicht: 170 g
 Gesamt-Gewicht: 950 g

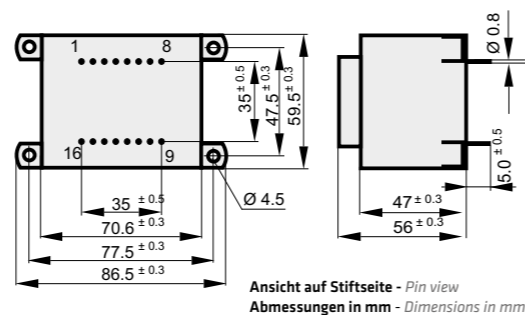

Ausführung / version

KK

Raster / pitch

35 mm

Stifte / pinning

2 x 8



Nennleistung/Nominal power

45 VA

Safety transformer
 VDE 0570 / EN 61558 / ENEC10
 UL 506 / CSA approved
 Vacuum casting
 Temperature class ta70°C/B
 Cul weight: 170 g
 Total weight: 950 g

Bestell Nr. <i>Order No.</i>	Primär [V] <i>Primary</i>	Sekundär [V] <i>Secondary</i>	Strom [A] <i>Current</i>	Stiftbelegung <i>Pin configuration</i>	Leerlaufspannung [V] <i>No load voltage</i>	Prüfzeichen / Approvals		
						VDE	5085-2/3	5085-1/2
V66.30/19295	230	6	7,50	1-8 / 11-14	6,80	●		●
V66.30/19296	230	9	5,00	1-8 / 11-14	10,20	●		●
V66.30/19297	230	12	3,75	1-8 / 11-14	13,90	●		●
V66.30/19298	230	15	3,00	1-8 / 11-14	17,15	●		●
V66.30/19299	230	18	2,50	1-8 / 11-14	20,45	●		●
V66.30/19300	230	24	1,88	1-8 / 11-14	26,90	●		●
V66.30/19301	230	2x6	2x3,75	1-8 / 9-10 + 15-16	2x6,80	●		●
V66.30/19302	230	2x7,5	2x3,00	1-8 / 9-10 + 15-16	2x8,70	●		●
V66.30/19303	230	2x9	2x2,50	1-8 / 9-10 + 15-16	2x10,51	●		●
V66.30/19304	230	2x12	2x1,88	1-8 / 9-10 + 15-16	2x13,80	●		●
V66.30/19305	230	2x15	2x1,50	1-8 / 9-10 + 15-16	2x17,15	●		●
V66.30/19306	230	2x18	2x1,25	1-8 / 9-10 + 15-16	2x20,85	●		●
V66.30/19307	230	2x24	2x0,94	1-8 / 9-10 + 15-16	2x27,25	●		●

Trenntransformator / isolation transformer

Typ/Type

EI66/34,7

Sicherheitstransformator
 VDE 0570 / EN 61558 / ENEC10 geprüft
 Vakuumverguss
 Temperaturklasse ta70°C/B
 Cul-Gewicht: 0,18 kg
 Gesamt-Gewicht: 1,08 kg

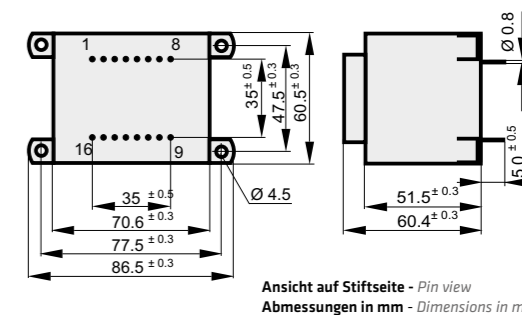

Nennleistung/Nominal power

50 VA

Safety transformer
 VDE 0570 / EN 61558 / ENEC10 approved
 Vacuum casting
 Temperature class ta70°C/B
 Cul weight: 0,18 kg
 Total weight: 1,08 kg

Ausführung / version

KK

Raster / pitch

35 mm

Stifte / pinning

2 x 8



Bestell Nr. <i>Order No.</i>	Primär [V] <i>Primary</i>	Sekundär [V] <i>Secondary</i>	Strom [A] <i>Current</i>	Stiftbelegung <i>Pin configuration</i>	Leerlaufspannung [V] <i>No load voltage</i>	Prüfzeichen / Approvals		
						VDE	5085-2/3	5085-1/2
V66.34/19400	230	6	8,33	1-8 / 11-14	6,60	●		
V66.34/19401	230	9	5,56	1-8 / 11-14	9,90	●		
V66.34/19402	230	12	4,17	1-8 / 11-14	13,20	●		
V66.34/19403	230	15	3,33	1-8 / 11-14	16,50	●		
V66.34/19404	230	18	2,78	1-8 / 11-14	19,80	●		
V66.34/19405	230	24	2,08	1-8 / 11-14	26,60	●		
V66.34/19406	230	2x6	2x4,17	1-8 / 9-10 + 15-16	2x6,60	●		
V66.34/19407	230	2x7,5	2x3,33	1-8 / 9-10 + 15-16	2x8,20	●		
V66.34/19408	230	2x9	2x2,78	1-8 / 9-10 + 15-16	2x10,00	●		
V66.34/19409	230	2x12	2x2,08	1-8 / 9-10 + 15-16	2x13,40	●		
V66.34/19410	230	2x15	2x1,67	1-8 / 9-10 + 15-16	2x16,70	●		
V66.34/19411	230	2x18	2x1,39	1-8 / 9-10 + 15-16	2x20,00	●		
V66.34/19412	230	2x24	2x1,04	1-8 / 9-10 + 15-16	2x26,50	●		

Trenntransformator / isolation transformer

Typ/Type

EI66/34,7

Sicherheitstransformator
 VDE 0570 / EN 61558 / ENEC10 geprüft
 Vakuumverguss
 Temperaturklasse ta70°C/B
 Cul-Gewicht: 0,18 kg
 Gesamt-Gewicht: 1,08 kg

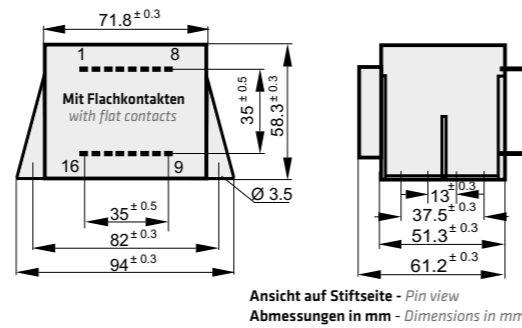

Ausführung / version

VL

Nennleistung/Nominal power

50 VA

Safety transformer
 VDE 0570 / EN 61558 / ENEC10 approved
 Vacuum casting
 Temperature class ta70°C/B
 Cul weight: 0,18 kg
 Total weight: 1,08 kg



Bestell Nr. <i>Order No.</i>	Primär [V] <i>Primary</i>	Sekundär [V] <i>Secondary</i>	Strom [A] <i>Current</i>	Stiftbelegung <i>Pin configuration</i>	Leerlaufspannung [V] <i>No load voltage</i>	Prüfzeichen / Approvals		
						VDE	5085-2/3	5085-1/2
V66.34/19396	230	6	8,33	1-8 / 11-14	6,60	●		
V66.34/19359	230	9	5,56	1-8 / 11-14	9,90	●		
V66.34/19360	230	12	4,17	1-8 / 11-14	13,20	●		
V66.34/19361	230	15	3,33	1-8 / 11-14	16,50	●		
V66.34/19362	230	18	2,78	1-8 / 11-14	19,80	●		
V66.34/19363	230	24	2,08	1-8 / 11-14	26,60	●		
V66.34/19364	230	2x6	2x4,17	1-8 / 9-10 + 15-16	2x6,60	●		
V66.34/19365	230	2x7,5	2x3,33	1-8 / 9-10 + 15-16	2x8,20	●		
V66.34/19366	230	2x9	2x2,78	1-8 / 9-10 + 15-16	2x10,00	●		
V66.34/19367	230	2x12	2x2,08	1-8 / 9-10 + 15-16	2x13,40	●		
V66.34/19368	230	2x15	2x1,67	1-8 / 9-10 + 15-16	2x16,70	●		
V66.34/19369	230	2x18	2x1,39	1-8 / 9-10 + 15-16	2x20,00	●		
V66.34/19370	230	2x24	2x1,04	1-8 / 9-10 + 15-16	2x26,50	●		

Trenntransformator / isolation transformer

Typ/Type

EI66/34,7

Sicherheitstransformator
 VDE 0570 / EN 61558 / ENEC10 geprüft
 Vakuumverguss
 Temperaturklasse ta70°C/B
 Cul-Gewicht: 0,18 kg
 Gesamt-Gewicht: 1,08 kg

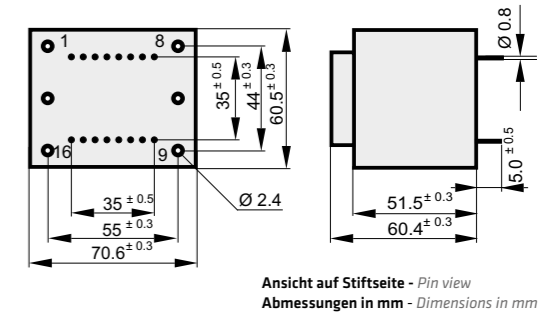

Nennleistung/Nominal power

50 VA

Safety transformer
 VDE 0570 / EN 61558 / ENEC10 approved
 Vacuum casting
 Temperature class ta70°C/B
 Cul weight: 0,18 kg
 Total weight: 1,08 kg



Bestell Nr. <i>Order No.</i>	Primär [V] <i>Primary</i>	Sekundär [V] <i>Secondary</i>	Strom [A] <i>Current</i>	Stiftbelegung <i>Pin configuration</i>	Leerlaufspannung [V] <i>No load voltage</i>	Prüfzeichen / Approvals		
						VDE	5085-2/3	5085-1/2
V66.34/19397	230	6	8,33	1-8 / 11-14	6,60	●		
V66.34/19371	230	9	5,56	1-8 / 11-14	9,90	●		
V66.34/19372	230	12	4,17	1-8 / 11-14	13,20	●		
V66.34/19373	230	15	3,33	1-8 / 11-14	16,50	●		
V66.34/19374	230	18	2,78	1-8 / 11-14	19,80	●		
V66.34/19375	230	24	2,08	1-8 / 11-14	26,60	●		
V66.34/19376	230	2x6	2x4,17	1-8 / 9-10 + 15-16	2x6,60	●		
V66.34/19377	230	2x7,5	2x3,33	1-8 / 9-10 + 15-16	2x8,20	●		
V66.34/19378	230	2x9	2x2,78	1-8 / 9-10 + 15-16	2x10,00	●		
V66.34/19379	230	2x12	2x2,08	1-8 / 9-10 + 15-16	2x13,40	●		
V66.34/19380	230	2x15	2x1,67	1-8 / 9-10 + 15-16	2x16,70	●		
V66.34/19381	230	2x18	2x1,39	1-8 / 9-10 + 15-16	2x20,00	●		
V66.34/19382	230	2x24	2x1,04	1-8 / 9-10 + 15-16	2x26,50	●		

Trenntransformator / isolation transformer

Ausführung / version

B0

Raster / pitch

35 mm

Stifte / pinning

2 x 8

Typ/Type

EI66/40

Sicherheitstransformator
 VDE 0570 / EN 61558 / ENEC10 geprüft
 Vakuumverguss
 Temperaturklasse ta70°C/B
 Cul-Gewicht: 0,205 kg
 Gesamt-Gewicht: 1,20 kg

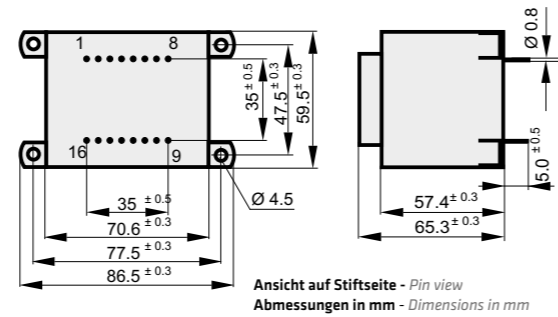

Nennleistung/Nominal power

52 VA

Safety transformer
 VDE 0570 / EN 61558 / ENEC10 approved
 Vacuum casting
 Temperature class ta70°C/B
 Cul weight: 0,205 kg
 Total weight: 1,20 kg

Ausführung / version

KK

Raster / pitch

35 mm

Stifte / pinning

2 x 8



Bestell Nr. <i>Order No.</i>	Primär [V] <i>Primary</i>	Sekundär [V] <i>Secondary</i>	Strom [A] <i>Current</i>	Stiftbelegung <i>Pin configuration</i>	Leerlaufspannung [V] <i>No load voltage</i>	Prüfzeichen / Approvals		
						VDE	5085-2/3	5085-1/2
V66.40/19384	230	6	8,67	1-8 / 11-14	7,40	●		
V66.40/19385	230	9	5,78	1-8 / 11-14	10,50	●		
V66.40/19386	230	12	4,33	1-8 / 11-14	13,80	●		
V66.40/19387	230	15	3,47	1-8 / 11-14	16,80	●		
V66.40/19388	230	18	2,89	1-8 / 11-14	20,15	●		
V66.40/19389	230	24	2,17	1-8 / 11-14	26,40	●		
V66.40/19390	230	2x6	2x4,33	1-8 / 9-10 + 15-16	2x6,90	●		
V66.40/19391	230	2x9	2x2,89	1-8 / 9-10 + 15-16	2x10,40	●		
V66.40/19392	230	2x12	2x2,17	1-8 / 9-10 + 15-16	2x13,60	●		
V66.40/19393	230	2x15	2x1,73	1-8 / 9-10 + 15-16	2x16,80	●		
V66.40/19394	230	2x18	2x1,44	1-8 / 9-10 + 15-16	2x20,40	●		

Typ/Type

EI78/27,5

Sicherheitstransformator
 VDE 0570 / EN 61558 / ENEC10
 UL 506 / CSA geprüft
 Vakuumverguss
 Temperaturklasse ta70°C/B
 Cul-Gewicht: 0,25 kg
 Gesamt-Gewicht: 1,28 kg

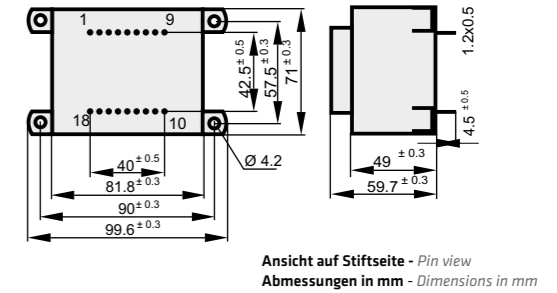

Nennleistung/Nominal power

55 VA

Safety transformer
 VDE 0570 / EN 61558 / ENEC10
 UL 506 / CSA approved
 Vacuum casting
 Temperature class ta70°C/B
 Cul weight: 0,25 kg
 Total weight: 1,28 kg

Ausführung / version

KK

Raster / pitch

42.5 mm

Stifte / pinning

2 x 9



Bestell Nr. <i>Order No.</i>	Primär [V] <i>Primary</i>	Sekundär [V] <i>Secondary</i>	Strom [A] <i>Current</i>	Stiftbelegung <i>Pin configuration</i>	Leerlaufspannung [V] <i>No load voltage</i>	Prüfzeichen / Approvals		
						VDE	5085-2/3	5085-1/2
V78.27/04214	230	6	9,17	2-8 / 12-16	6,65	●		●
V78.27/04215	230	9	6,11	2-8 / 12-16	10,20	●		●
V78.27/04216	230	12	4,58	2-8 / 12-16	13,70	●		●
V78.27/04217	230	15	3,67	2-8 / 12-16	17,05	●		●
V78.27/04218	230	18	3,06	2-8 / 12-16	20,50	●		●
V78.27/04219	230	24	2,29	2-8 / 12-16	27,10	●		●
V78.27/04220	230	2x6	2x4,58	2-8 / 11-13 + 15-17	2x6,70	●		●
V78.27/04221	230	2x9	2x3,06	2-8 / 11-13 + 15-17	2x10,20	●		●
V78.27/04222	230	2x12	2x2,29	2-8 / 11-13 + 15-17	2x13,60	●		●
V78.27/04223	230	2x15	2x1,83	2-8 / 11-13 + 15-17	2x17,10	●		●
V78.27/04224	230	2x18	2x1,53	2-8 / 11-13 + 15-17	2x20,60	●		●

Typ/Type

EI78/36,5

Sicherheitstransformator
VDE 0570 / EN 61558 / ENEC10
UL 506 / CSA geprüft
Vakuumverguss
Temperaturklasse ta70°C/B
Cul-Gewicht: 0,265 kg
Gesamt-Gewicht: 1,60 kg

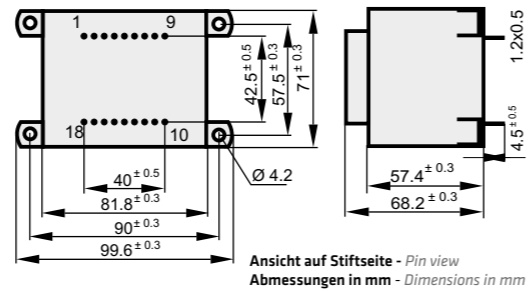

Ausführung / version

KK

Raster / pitch

42.5 mm 2 x 9

Stifte / pinning



Nennleistung/Nominal power

65 VA

Safety transformer
VDE 0570 / EN 61558 / ENEC10
UL 506 / CSA approved
Vacuum casting
Temperature class ta70°C/B
Cul weight: 0,265 kg
Total weight: 1,60 kg

Bestell Nr. <i>Order No.</i>	Primär [V] <i>Primary</i>	Sekundär [V] <i>Secondary</i>	Strom [A] <i>Current</i>	Stiftbelegung <i>Pin configuration</i>	Leerlaufspannung [V] <i>No load voltage</i>	Prüfzeichen / Approvals		
						VDE	5085-2/3	5085-1/2
V78.36/04225	230	6	10,83	2-8 / 12-16	6,55	●		●
V78.36/04226	230	9	7,22	2-8 / 12-16	9,80	●		●
V78.36/04227	230	12	5,42	2-8 / 12-16	13,15	●		●
V78.36/04228	230	15	4,33	2-8 / 12-16	16,40	●		●
V78.36/04229	230	18	3,61	2-8 / 12-16	19,70	●		●
V78.36/04230	230	24	2,71	2-8 / 12-16	26,25	●		●
V78.36/04231	230	2x6	2x5,42	2-8 / 11-13 + 15-17	2x6,50	●		●
V78.36/04232	230	2x9	2x3,61	2-8 / 11-13 + 15-17	2x9,70	●		●
V78.36/04233	230	2x12	2x2,71	2-8 / 11-13 + 15-17	2x13,10	●		●
V78.36/04234	230	2x15	2x2,17	2-8 / 11-13 + 15-17	2x16,30	●		●
V78.36/04235	230	2x18	2x1,81	2-8 / 11-13 + 15-17	2x19,60	●		●

Typ/Type

EI78/40,5

Sicherheitstransformator
VDE 0570 / EN 61558 / ENEC10
UL 506 / CSA geprüft
Vakuumverguss
Temperaturklasse ta70°C/B
Cul-Gewicht: 0,285 kg
Gesamt-Gewicht: 1,71 kg

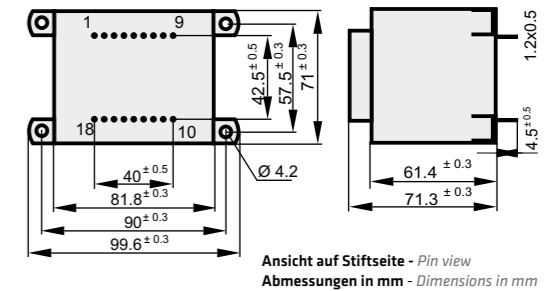

Nennleistung/Nominal power

80 VA

Safety transformer
VDE 0570 / EN 61558 / ENEC10
UL 506 / CSA approved
Vacuum casting
Temperature class ta70°C/B
Cul weight: 0,285 kg
Total weight: 1,71 kg

Ausführung / version

KK

Raster / pitch

42.5 mm 2 x 9

Stifte / pinning



Bestell Nr. <i>Order No.</i>	Primär [V] <i>Primary</i>	Sekundär [V] <i>Secondary</i>	Strom [A] <i>Current</i>	Stiftbelegung <i>Pin configuration</i>	Leerlaufspannung [V] <i>No load voltage</i>	Prüfzeichen / Approvals		
						VDE	5085-2/3	5085-1/2
V78.40/04236	230	6	13,33	2-8 / 12-16	6,55	●		●
V78.40/04237	230	9	8,89	2-8 / 12-16	9,75	●		●
V78.40/04238	230	12	6,67	2-8 / 12-16	13,10	●		●
V78.40/04239	230	15	5,33	2-8 / 12-16	16,35	●		●
V78.40/04240	230	18	4,44	2-8 / 12-16	19,80	●		●
V78.40/04241	230	24	3,33	2-8 / 12-16	26,30	●		●
V78.40/04242	230	2x6	2x6,67	2-8 / 11-13 + 15-17	2x6,50	●		●
V78.40/04243	230	2x9	2x4,44	2-8 / 11-13 + 15-17	2x9,70	●		●
V78.40/04244	230	2x12	2x3,33	2-8 / 11-13 + 15-17	2x13,10	●		●
V78.40/04245	230	2x15	2x2,67	2-8 / 11-13 + 15-17	2x16,30	●		●
V78.40/04246	230	2x18	2x2,22	2-8 / 11-13 + 15-17	2x19,75	●		●

Typ/Type

EI84/29,5

Sicherheitstransformator
 VDE 0570 / EN 61558 / ENEC10 geprüft
 Vakuumverguss
 Temperaturklasse ta70°C/B
 Cul-Gewicht: 0,29 kg
 Gesamt-Gewicht: 1,59 kg

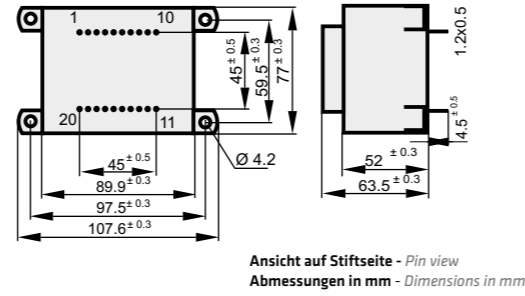

Nennleistung/Nominal power

75 VA

Safety transformer
 VDE 0570 / EN 61558 / ENEC10 approved
 Vacuum casting
 Temperature class ta70°C/B
 Cul weight: 0,29 kg
 Total weight: 1,59 kg

Ausführung / version

KK

Raster / pitch

45 mm

Stifte / pinning

2 x 10



Bestell Nr. <i>Order No.</i>	Primär [V] <i>Primary</i>	Sekundär [V] <i>Secondary</i>	Strom [A] <i>Current</i>	Stiftbelegung <i>Pin configuration</i>	Leerlaufspannung [V] <i>No load voltage</i>	Prüfzeichen / Approvals		
						VDE	5085-2/3	5085-1/2
V84.29/04339	230	6	12,50	2-9 / 14-17	6,50	●		
V84.29/04340	230	9	8,33	2-9 / 14-17	9,65	●		
V84.29/04341	230	12	6,25	2-9 / 14-17	13,10	●		
V84.29/04342	230	15	5,00	2-9 / 14-17	16,40	●		
V84.29/04343	230	18	4,17	2-9 / 14-17	19,60	●		
V84.29/04344	230	24	3,13	2-9 / 14-17	26,10	●		
V84.29/04345	230	2x6	2x6,25	2-9 / 12-14 + 17-19	2x6,45	●		
V84.29/04346	230	2x9	2x4,17	2-9 / 12-14 + 17-19	2x9,60	●		
V84.29/04347	230	2x12	2x3,13	2-9 / 12-14 + 17-19	2x13,10	●		
V84.29/04361	230	2x15	2x2,50	2-9 / 12-14 + 17-19	2x16,30	●		
V84.29/04349	230	2x18	2x2,08	2-9 / 12-14 + 17-19	2x19,55	●		

Typ/Type

EI84/43,5

Sicherheitstransformator
 VDE 0570 / EN 61558 / ENEC10 geprüft
 Vakuumverguss
 Temperaturklasse ta70°C/B
 Cul-Gewicht: 0,31 kg
 Gesamt-Gewicht: 2,14 kg

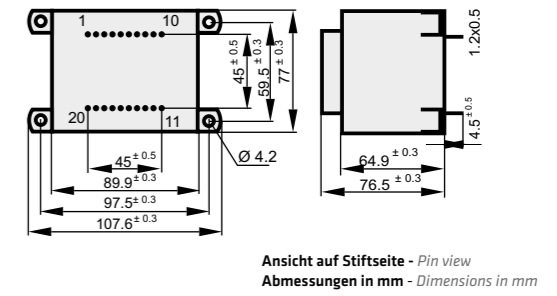

Nennleistung/Nominal power

100 VA

Safety transformer
 VDE 0570 / EN 61558 / ENEC10 approved
 Vacuum casting
 Temperature class ta70°C/B
 Cul weight: 0,31 kg
 Total weight: 2,14 kg

Ausführung / version

KK

Raster / pitch

45 mm

Stifte / pinning

2 x 10



Bestell Nr. <i>Order No.</i>	Primär [V] <i>Primary</i>	Sekundär [V] <i>Secondary</i>	Strom [A] <i>Current</i>	Stiftbelegung <i>Pin configuration</i>	Leerlaufspannung [V] <i>No load voltage</i>	Prüfzeichen / Approvals		
						VDE	5085-2/3	5085-1/2
V84.43/04350	230	6	16,67	2-9 / 14-17	6,45	●		
V84.43/04351	230	9	11,11	2-9 / 14-17	9,80	●		
V84.43/04352	230	12	8,33	2-9 / 14-17	13,00	●		
V84.43/04353	230	15	6,67	2-9 / 14-17	16,15	●		
V84.43/04354	230	18	5,56	2-9 / 14-17	19,40	●		
V84.43/04355	230	24	4,17	2-9 / 14-17	26,20	●		
V84.43/04356	230	2x6	2x8,33	2-9 / 12-14 + 17-19	2x6,40	●		
V84.43/04357	230	2x9	2x5,56	2-9 / 12-14 + 17-19	2x9,80	●		
V84.43/04358	230	2x12	2x4,17	2-9 / 12-14 + 17-19	2x13,00	●		
V84.43/04359	230	2x15	2x3,33	2-9 / 12-14 + 17-19	2x16,10	●		
V84.43/04360	230	2x18	2x2,78	2-9 / 12-14 + 17-19	2x19,35	●		

Typ/Type

EI96/35,7

Sicherheitstransformator
nach VDE 0570 / EN 61558
UL 506 / CSA
Vakuummverguss
Temperaturklasse ta70°C/B
Cul-Gewicht: 0,48 kg
Gesamt-Gewicht: 2,45 kg

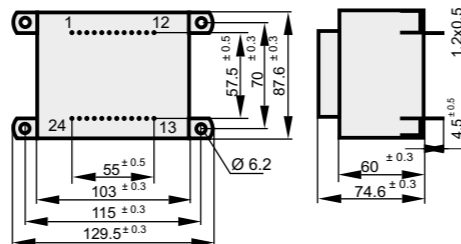

Ansicht auf Stiftseite - Pin view
Abmessungen in mm - Dimensions in mm

Nennleistung/Nominal power

140 VA

Safety transformer
according to VDE 0570 / EN 61558
UL 506 / CSA
Vacuum casting
Temperature class ta70°C/B
Cul weight: 0,48 kg
Total weight: 2,45 kg

Ausführung / version

KK

Raster / pitch

57,5 mm 2 x 12

Stifte / pinning



Bestell Nr. <i>Order No.</i>	Primär [V] <i>Primary</i>	Sekundär [V] <i>Secondary</i>	Strom [A] <i>Current</i>	Stiftbelegung <i>Pin configuration</i>	Leerlaufspannung [V] <i>No load voltage</i>	Prüfzeichen / Approvals		
						VDE	5085-2/3	5085-1/2
V96.35/53017	230	6	23,33	3-9 / 16-20	6,50			•
V96.35/53018	230	9	15,56	3-9 / 16-20	9,80			•
V96.35/53019	230	12	11,67	3-9 / 16-20	13,05			•
V96.35/53020	230	15	9,33	3-9 / 16-20	16,10			•
V96.35/53021	230	18	7,78	3-9 / 16-20	19,45			•
V96.35/53022	230	24	5,83	3-9 / 16-20	25,90			•
V96.35/53023	230	2x6	2x11,67	3-9 / 14-17 + 20-23	2x6,50			•
V96.35/53024	230	2x9	2x7,78	3-9 / 14-17 + 20-23	2x9,75			•
V96.35/53025	230	2x12	2x5,83	3-9 / 14-17 + 20-23	2x13,10			•
V96.35/53026	230	2x15	2x4,67	3-9 / 14-17 + 20-23	2x16,20			•
V96.35/53027	230	2x18	2x3,89	3-9 / 14-17 + 20-23	2x19,50			•

Typ/Type

EI96/45,7

Sicherheitstransformator
nach VDE 0570 / EN 61558
UL 506 / CSA
Vakuummverguss
Temperaturklasse ta40°C/B
Cul-Gewicht: 0,53 kg
Gesamt-Gewicht: 3,02 kg

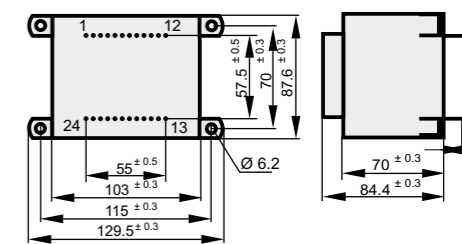

Ansicht auf Stiftseite - Pin view
Abmessungen in mm - Dimensions in mm

Nennleistung/Nominal power

180 VA

Safety transformer
according to VDE 0570 / EN 61558
UL 506 / CSA
Vacuum casting
Temperature class ta40°C/B
Cul weight: 0,53 kg
Total weight: 3,02 kg

Ausführung / version

KK

Raster / pitch

57,5 mm 2 x 12

Stifte / pinning



Bestell Nr. <i>Order No.</i>	Primär [V] <i>Primary</i>	Sekundär [V] <i>Secondary</i>	Strom [A] <i>Current</i>	Stiftbelegung <i>Pin configuration</i>	Leerlaufspannung [V] <i>No load voltage</i>	Prüfzeichen / Approvals		
						VDE	5085-2/3	5085-1/2
V96.45/53028	230	6	30,0	2-11 / 16-21	6,50			•
V96.45/53029	230	9	20,0	2-11 / 16-21	9,60			•
V96.45/53030	230	12	15,0	2-11 / 16-21	12,90			•
V96.45/53031	230	15	12,0	2-11 / 16-21	15,90			•
V96.45/53032	230	18	10,0	2-11 / 16-21	19,20			•
V96.45/53033	230	24	7,5	2-11 / 16-21	25,90			•
V96.45/53034	230	2x6	2x30,0	2-11 / 14-17 + 20-23	2x6,50			•
V96.45/53035	230	2x9	2x10,0	2-11 / 14-17 + 20-23	2x9,60			•
V96.45/53036	230	2x12	2x7,5	2-11 / 14-17 + 20-23	2x13,00			•
V96.45/53037	230	2x15	2x6,0	2-11 / 14-17 + 20-23	2x15,95			•
V96.45/53038	230	2x18	2x5,0	2-11 / 14-17 + 20-23	2x19,20			•

Typ/Type

EI96/59,7

Sicherheitstransformator
nach VDE 0570 / EN 61558
UL 506 / CSA
Vakuumvergossen
Temperaturklasse ta40°C/B
Cul-Gewicht: 0,57 kg
Gesamt-Gewicht: 3,68 kg

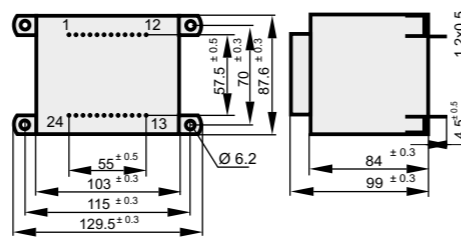

Ansicht auf Stiftseite - Pin view
Abmessungen in mm - Dimensions in mm

Nennleistung/Nominal power

220 VA

Safety transformer
according to VDE 0570 / EN 61558
UL 506 / CSA
Vacuum casting
Temperature class ta40°C/B
Cul weight: 0,57 kg
Total weight: 3,68 kg

Ausführung / version

KK

Raster / pitch

57,5 mm 2 x 12

Stifte / pinning



Bestell Nr. <i>Order No.</i>	Primär [V] <i>Primary</i>	Sekundär [V] <i>Secondary</i>	Strom [A] <i>Current</i>	Stiftbelegung <i>Pin configuration</i>	Leerlaufspannung [V] <i>No load voltage</i>	Prüfzeichen / Approvals		
						VDE	5085-2/3	5085-1/2
V96.59/53039	230	6	36,67	2-11 / 16-21	6,45			●
V96.59/53040	230	9	24,44	2-11 / 16-21	9,65			●
V96.59/53041	230	12	18,33	2-11 / 16-21	13,00			●
V96.59/53042	230	15	14,67	2-11 / 16-21	16,20			●
V96.59/53043	230	18	12,22	2-11 / 16-21	19,00			●
V96.59/53044	230	24	9,17	2-11 / 16-21	26,00			●
V96.59/53045	230	2x6	2x18,33	2-11 / 14-17 + 20-23	2x6,40			●
V96.59/53046	230	2x9	2x12,22	2-11 / 14-17 + 20-23	2x9,75			●
V96.59/53047	230	2x12	2x9,17	2-11 / 14-17 + 20-23	2x13,00			●
V96.59/53048	230	2x15	2x7,33	2-11 / 14-17 + 20-23	2x16,30			●
V96.59/53049	230	2x18	2x6,11	2-11 / 14-17 + 20-23	2x19,50			●

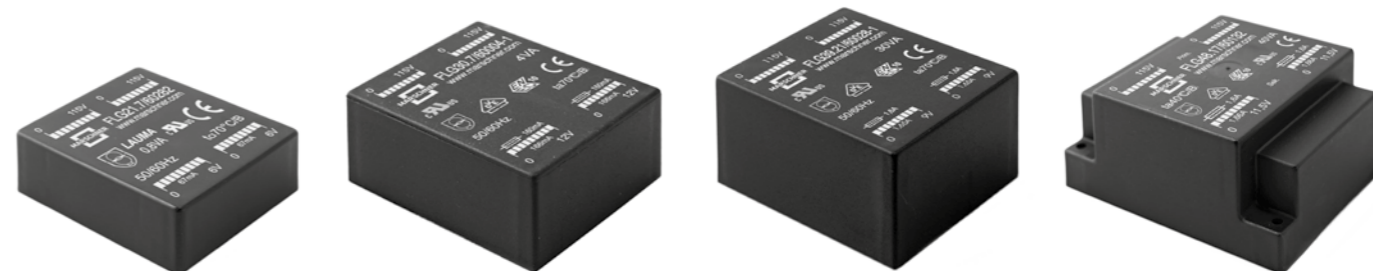

Entscheidende Vorteile unserer UI21 - UI48-Transformatoren:

- extrem flache Bauweise
- Leistungsbereich von 0.8 - 65.0 VA
- Eingangs- und Ausgangsspannungen für Reihen- und Parallelschaltung
- ausgezeichnetes Temperaturwechselverhalten durch Vakuumverguss
- unbedingt kurzschlussfest / nicht kurzschlussfest
- Absicherung extern durch PTC möglich
- 100% stückgeprüft mit 4000 V PRI-SEC
- Temperatur-/Isolierstoffklasse ta 40°C/B, ta 70°C/B
- höchste Sicherheit und Langlebigkeit
- VDE-, UL-, CSA-, ENEC10-Prüfzeichen
- fester Sitz auf der Leiterplatte durch hohe Anzahl an Lötstiften und zusätzlich innenliegender Befestigungsmöglichkeiten
- verwechslungsfreie Bestückung
- geringer Unterschied zwischen Leerlauf- und Lastausgangsspannung
- Zweikammer-Wicklung
- hohe Stoßspannungsfestigkeit
- selbstverlöschendes Haubenmaterial

Key advantages of our UI21 - UI48-transformers:

- transformers with minimal height
- power range 0.8 - 65.0 VA
- input and output voltages for series or parallel connection
- excellent temperature-change behavior owing to vacuum casting
- inherently short circuit proof / non-short-circuit-proof
- secondary protection by means of external PTC resistances possible
- 100% unit checked with 4000 V PRI-SEC
- ambient temperature insulation class ta 40°C/B, ta 70°C/B
- highest safety and lifetime
- VDE, UL, CSA, ENEC10 approvals
- snug fit on PCB through high number of pins and additional inside fixing
- no confusing pinning because of exact marking of pinning
- low difference between no-load and load output voltage
- split bobbin, two chamber winding
- high surge capability
- self-extinguishing case material

Sämtliche Baugrößen können wir nach Kundenwunsch anpassen:

- weitere PRI-SEC-Spannungen
- individuelle Leistungen
- spezielle PIN-Belegung
- höhere Temperaturklassen
- eingebaute Thermosicherung/-schalter möglich

Customization of all sizes is possible:

- further PRI-SEC voltages
- individual power values
- special PIN configurations
- higher temperature classes
- installed thermal fuse/thermal switch optionally available

Typ <i>Type</i>	Abmessungen (B x T x H) [mm] <i>Dimensions (L x W x H)</i>	Leistung bei ta 70°C/B [VA] <i>Power at ta 70°C/B</i>
UI21/7,3	34.0 x 31.0 x 14.9	0.8 / 1.0*
UI30/5,5	52.6 x 43.6 x 17.0	2.0* / 3.0
UI30/7,5	52.6 x 43.6 x 19.0	4.0
UI30/10,5	52.6 x 43.6 x 22.5	6.0
UI30/16,5	53.0 x 43.9 x 28.0	10.0
UI30/26	53.0 x 44.0 x 37.5	16.0
UI39/8	67.5 x 56.8 x 22.4	10.0
UI39/10,2	67.5 x 57.2 x 23.8	14.0
UI39/13,5	68.0 x 57.2 x 26.8	18.0
UI39/17	68.0 x 57.2 x 31.0	24.0
UI39/21	68.0 x 57.2 x 35.0	30.0
UI48/17	83.7 x 70.3 x 38.7	40.0 / 50.0**
UI48/26	83.7 x 70.3 x 47.7	60.0 / 65.0**

* unbedingt kurzschlussfest

* inherently short-circuit-proof

** bei ta 40°C/B

** at ta 40°C/B

Typ/Type

UI21/7,3

Sicherheitstransformator / Kurzschlußfest
nach VDE 0570 / EN 61558
UL 506 / CSA
Vakuumverguss
Temperaturklasse ta70°C/B
Cul-Gewicht: 11 g
Gesamt-Gewicht: 60 g

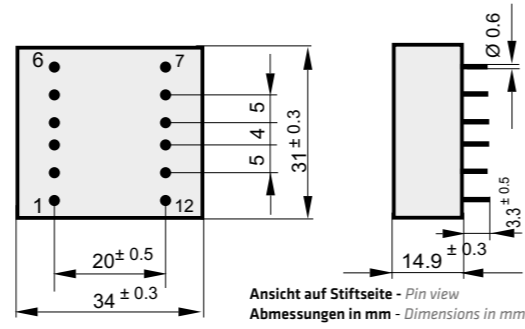

Nennleistung/Nominal power

0.8 VA

Safety transformer / Short-circuit-proof
according to VDE 0570 / EN 61558
UL 506 / CSA
Vacuum casting
Temperature class ta70°C/B
Cul weight: 11 g
Total weight: 60 g



Bestell Nr. <i>Order No.</i>	Primär [V] <i>Primary</i>	Sekundär [V] <i>Secondary</i>	Strom [mA] <i>Current</i>	Stiftbelegung <i>Pin configuration</i>	Leerlaufspannung [V] <i>No load voltage</i>	Prüfzeichen / Approvals		
						VDE	5085-2/3	5085-1/2
FLG21.7/60591	2x115	2x6	2x66,70	1-3 + 4-6 / 7-8 +11-12	2x10,10			●
FLG21.7/60592	2x115	2x9	2x44,40	1-3 + 4-6 / 7-8 +11-12	2x15,30			●
FLG21.7/60593	2x115	2x12	2x33,30	1-3 + 4-6 / 7-8 +11-12	2x20,10			●
FLG21.7/60594	2x115	2x15	2x26,70	1-3 + 4-6 / 7-8 +11-12	2x24,60			●
FLG21.7/60595	2x115	2x18	2x22,20	1-3 + 4-6 / 7-8 +11-12	2x30,00			●

Trenntransformator / isolation transformer

Typ/Type

UI21/7,3

Sicherheitstransformator / Kurzschlußfest
nach VDE 0570 / EN 61558
UL 506 / CSA
Vakuumverguss
Temperaturklasse ta70°C/B
Cul-Gewicht: 11 g
Gesamt-Gewicht: 60 g

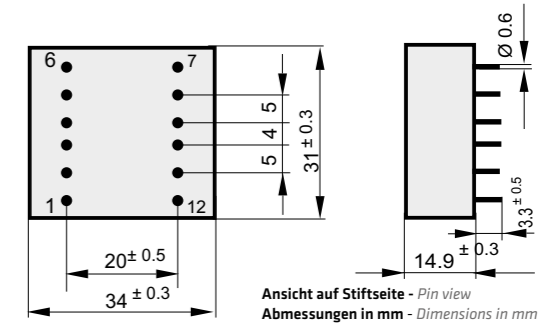

Nennleistung/Nominal power

1.0 VA

Safety transformer / Short-circuit-proof
according to VDE 0570 / EN 61558
UL 506 / CSA
Vacuum casting
Temperature class ta70°C/B
Cul weight: 11 g
Total weight: 60 g

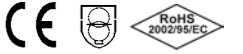

Bestell Nr. <i>Order No.</i>	Primär [V] <i>Primary</i>	Sekundär [V] <i>Secondary</i>	Strom [mA] <i>Current</i>	Stiftbelegung <i>Pin configuration</i>	Leerlaufspannung [V] <i>No load voltage</i>	Prüfzeichen / Approvals		
						VDE	UL 1585	UL 506
FLG21.7/60596	2x115	2x6	2x83,30	1-3 + 4-6 / 7-8 +11-12	2x10,30			
FLG21.7/60597	2x115	2x9	2x55,60	1-3 + 4-6 / 7-8 +11-12	2x15,70			
FLG21.7/60598	2x115	2x12	2x41,70	1-3 + 4-6 / 7-8 +11-12	2x20,80			
FLG21.7/60599	2x115	2x15	2x33,30	1-3 + 4-6 / 7-8 +11-12	2x24,50			
FLG21.7/60600	2x115	2x18	2x27,80	1-3 + 4-6 / 7-8 +11-12	2x30,10			

Trenntransformator / isolation transformer

Typ/Type

UI30/5,5

Sicherheitstransformator / Kurzschlußfest
 VDE 0570 / EN 61558 / ENEC10
 UL 506 / CSA geprüft
 Vakuumverguss
 Temperaturklasse ta70°C/B
 Cul-Gewicht: 40 g
 Gesamt-Gewicht: 125 g

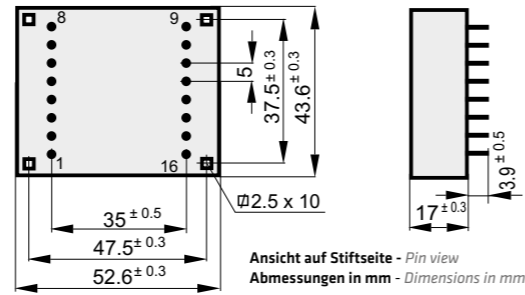

Nennleistung/Nominal power

2.0 VA

Safety transformer / Short-circuit-proof
 VDE 0570 / EN 61558 / ENEC10
 UL 506 / CSA approved
 Vacuum casting
 Temperature class ta70°C/B
 Cul weight: 40 g
 Total weight: 125 g



Bestell Nr. <i>Order No.</i>	Primär [V] <i>Primary</i>	Sekundär [V] <i>Secondary</i>	Strom [mA] <i>Current</i>	Stiftbelegung <i>Pin configuration</i>	Leerlaufspannung [V] <i>No load voltage</i>	Prüfzeichen / Approvals		
						VDE	5085-2/3	5085-1/2
FLG30.5/60506	2x115	2x6	2x167,00	1-3+ 6-8 / 9-10+15-16	2x9,30	●		●
FLG30.5/60507	2x115	2x9	2x111,00	1-3+ 6-8 / 9-10+15-16	2x13,40	●		●
FLG30.5/60508	2x115	2x12	2x83,30	1-3+ 6-8 / 9-10+15-16	2x18,00	●		●
FLG30.5/60509	2x115	2x15	2x66,60	1-3+ 6-8 / 9-10+15-16	2x22,50	●		●
FLG30.5/60510	2x115	2x18	2x55,50	1-3+ 6-8 / 9-10+15-16	2x24,90	●		●
FLG30.5/60511	2x115	2x24	2x41,60	1-3+ 6-8 / 9-10+15-16	2x34,20			●

Trenntransformator / isolation transformer

Typ/Type

UI30/5,5

Sicherheitstransformator
 VDE 0570 / EN 61558 / ENEC10 geprüft
 Vakuumverguss
 Temperaturklasse ta70°C/B
 Cul-Gewicht: 40 g
 Gesamt-Gewicht: 125 g

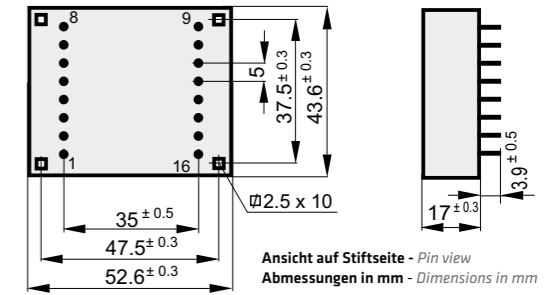

Nennleistung/Nominal power

3.0 VA

Safety transformer
 VDE 0570 / EN 61558 / ENEC10 approved
 Vacuum casting
 Temperature class ta70°C/B
 Cul weight: 40 g
 Total weight: 125 g



Bestell Nr. <i>Order No.</i>	Primär [V] <i>Primary</i>	Sekundär [V] <i>Secondary</i>	Strom [mA] <i>Current</i>	Stiftbelegung <i>Pin configuration</i>	Leerlaufspannung [V] <i>No load voltage</i>	Prüfzeichen / Approvals		
						VDE	5085-2/3	5085-1/2
FLG30.5/60601	2x115	2x6	2x250	1-3+6-8 / 9-10+15-16	2x9,30	●		
FLG30.5/60602	2x115	2x9	2x166	1-3+6-8 / 9-10+15-16	2x13,19	●		
FLG30.5/60603	2x115	2x12	2x125	1-3+6-8 / 9-10+15-16	2x17,90	●		
FLG30.5/60604	2x115	2x15	2x100	1-3+6-8 / 9-10+15-16	2x22,13	●		
FLG30.5/60605	2x115	2x18	2x83	1-3+6-8 / 9-10+15-16	2x26,88	●		
FLG30.5/60606	2x115	2x24	2x63	1-3+6-8 / 9-10+15-16	2x35,65			

Trenntransformator / isolation transformer

Typ/Type

UI30/7,5

Sicherheitstransformator
 VDE 0570 / EN 61558 / ENEC10
 UL 506 / CSA geprüft
 Vakuumverguss
 Temperaturklasse ta70°C/B
 Cul-Gewicht: 50 g
 Gesamt-Gewicht: 150 g

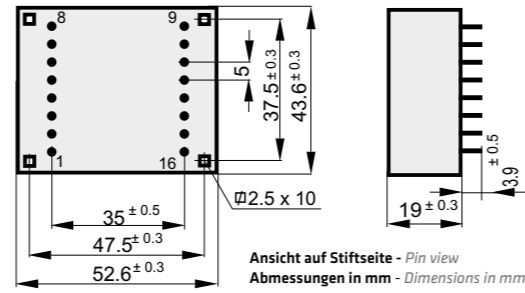

Nennleistung/Nominal power

4.0 VA

Safety transformer
 VDE 0570 / EN 61558 / ENEC10
 UL 506 / CSA approved
 Vacuum casting
 Temperature class ta70°C/B
 Cul weight: 50 g
 Total weight: 150 g



Bestell Nr. <i>Order No.</i>	Primär [V] <i>Primary</i>	Sekundär [V] <i>Secondary</i>	Strom [mA] <i>Current</i>	Stiftbelegung <i>Pin configuration</i>	Leerlaufspannung [V] <i>No load voltage</i>	Prüfzeichen / Approvals		
						VDE	5085-2/3	5085-1/2
FLG30.7/60031-1	2x115	2x6	2x333	1-3+6-8 / 9-10+15-16	2x9,20	●		●
FLG30.7/60063-1	2x115	2x7,5	2x266	1-3+6-8 / 9-10+15-16	2x11,40	●		●
FLG30.7/60032-1	2x115	2x9	2x222	1-3+6-8 / 9-10+15-16	2x13,70	●		●
FLG30.7/60004-1	2x115	2x12	2x166	1-3+6-8 / 9-10+15-16	2x17,90	●		●
FLG30.7/60005-1	2x115	2x15	2x133	1-3+6-8 / 9-10+15-16	2x22,40	●		●
FLG30.7/60006-1	2x115	2x18	2x111	1-3+6-8 / 9-10+15-16	2x24,00	●		●
FLG30.7/60033-1	2x115	2x24	2x83	1-3+6-8 / 9-10+15-16	2x35,40	●		●

Trenntransformator / isolation transformer

Typ/Type

UI30/10,5

Sicherheitstransformator
 VDE 0570 / EN 61558 / ENEC10
 UL 506 / CSA geprüft
 Vakuumverguss
 Temperaturklasse ta70°C/B
 Cul-Gewicht: 60 g
 Gesamt-Gewicht: 180 g

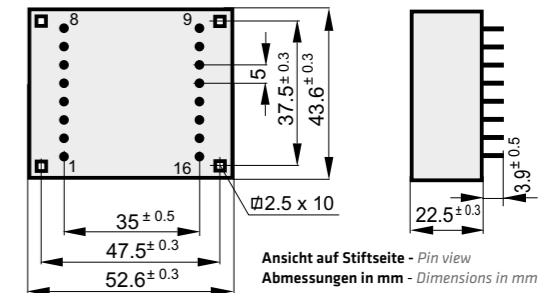

Nennleistung/Nominal power

6.0 VA

Safety transformer
 VDE 0570 / EN 61558 / ENEC10
 UL 506 / CSA approved
 Vacuum casting
 Temperature class ta70°C/B
 Cul weight: 60 g
 Total weight: 180 g



Bestell Nr. <i>Order No.</i>	Primär [V] <i>Primary</i>	Sekundär [V] <i>Secondary</i>	Strom [mA] <i>Current</i>	Stiftbelegung <i>Pin configuration</i>	Leerlaufspannung [V] <i>No load voltage</i>	Prüfzeichen / Approvals		
						VDE	5085-2/3	5085-1/2
FLG30.10/60034-1	2x115	2x6	2x500	1-3+6-8 / 9-10+15-16	2x8,40	●		●
FLG30.10/60067-1	2x115	2x7,5	2x400	1-3+6-8 / 9-10+15-16	2x10,40	●		●
FLG30.10/60035-1	2x115	2x9	2x333	1-3+6-8 / 9-10+15-16	2x12,40	●		●
FLG30.10/60007-1	2x115	2x12	2x250	1-3+6-8 / 9-10+15-16	2x16,30	●		●
FLG30.10/60008-1	2x115	2x15	2x200	1-3+6-8 / 9-10+15-16	2x20,30	●		●
FLG30.10/60009-1	2x115	2x18	2x166	1-3+6-8 / 9-10+15-16	2x23,80	●		●
FLG30.10/60036-1	2x115	2x24	2x125	1-3+6-8 / 9-10+15-16	2x31,90	●		●

Trenntransformator / isolation transformer

Typ/Type

UI30/16,5

Sicherheitstransformator
 VDE 0570 / EN 61558 / ENEC10
 UL 506 / CSA geprüft
 Vakuumverguss
 Temperaturklasse ta70°C/B
 Cul-Gewicht: 70 g
 Gesamt-Gewicht: 260 g

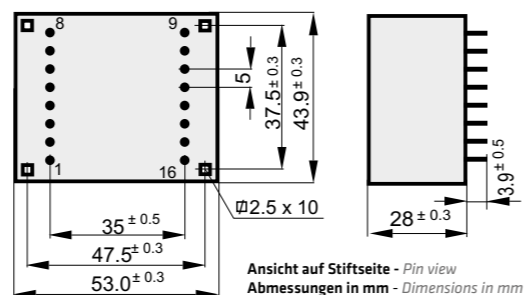

Nennleistung/Nominal power

10.0 VA

Safety transformer
 VDE 0570 / EN 61558 / ENEC10
 UL 506 / CSA approved
 Vacuum casting
 Temperature class ta70°C/B
 Cul weight: 70 g
 Total weight: 260 g



Bestell Nr. <i>Order No.</i>	Primär [V] <i>Primary</i>	Sekundär [V] <i>Secondary</i>	Strom [mA] <i>Current</i>	Stiftbelegung <i>Pin configuration</i>	Leerlaufspannung [V] <i>No load voltage</i>	Prüfzeichen / Approvals		
						VDE	5085-2/3	5085-1/2
FLG30.16/60246-1	2x115	2x6	2x833	1-3+6-8 / 9-10+15-16	2x7,70	●		●
FLG30.16/60144-1	2x115	2x7,5	2x666	1-3+6-8 / 9-10+15-16	2x9,40	●		●
FLG30.16/60247-1	2x115	2x9	2x555	1-3+6-8 / 9-10+15-16	2x11,50	●		●
FLG30.16/60010-1	2x115	2x12	2x416	1-3+6-8 / 9-10+15-16	2x14,80	●		●
FLG30.16/60011-1	2x115	2x15	2x333	1-3+6-8 / 9-10+15-16	2x18,40	●		●
FLG30.16/60012-1	2x115	2x18	2x277	1-3+6-8 / 9-10+15-16	2x22,20	●		●
FLG30.16/60248-1	2x115	2x24	2x208	1-3+6-8 / 9-10+15-16	2x30,50	●		●

Trenntransformator / isolation transformer

Typ/Type

UI30/26

Sicherheitstransformator
 VDE 0570 / EN 61558 / ENEC10 geprüft
 Vakuumverguss
 Temperaturklasse ta70°C/B
 Cul-Gewicht: 75 g
 Gesamt-Gewicht: 300 g

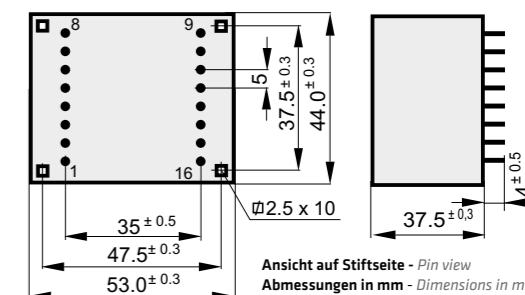

Nennleistung/Nominal power

16.0 VA

Safety transformer
 VDE 0570 / EN 61558 / ENEC10 approved
 Vacuum casting
 Temperature class ta70°C/B
 Cul weight: 75 g
 Total weight: 300 g



Bestell Nr. <i>Order No.</i>	Primär [V] <i>Primary</i>	Sekundär [V] <i>Secondary</i>	Strom [mA] <i>Current</i>	Stiftbelegung <i>Pin configuration</i>	Leerlaufspannung [V] <i>No load voltage</i>	Prüfzeichen / Approvals		
						VDE	5085-2/3	5085-1/2
FLG30.26/60249-1	2x115	2x6	2x1333	1-3+6-8 / 9-10+15-16	2x7,20	●		
FLG30.26/60145-1	2x115	2x7,5	2x1066	1-3+6-8 / 9-10+15-16	2x9,00	●		
FLG30.26/60250-1	2x115	2x9	2x888	1-3+6-8 / 9-10+15-16	2x10,60	●		
FLG30.26/60013-1	2x115	2x12	2x666	1-3+6-8 / 9-10+15-16	2x13,90	●		
FLG30.26/60014-1	2x115	2x15	2x533	1-3+6-8 / 9-10+15-16	2x17,80	●		
FLG30.26/60015-1	2x115	2x18	2x444	1-3+6-8 / 9-10+15-16	2x21,00	●		
FLG30.26/60251-1	2x115	2x24	2x333	1-3+6-8 / 9-10+15-16	2x28,60	●		

Trenntransformator / isolation transformer

Typ/Type

UI39/8

Sicherheitstransformator
 VDE 0570 / EN 61558 / ENEC10
 UL 506 / CSA geprüft
 Vakuumverguss
 Temperaturklasse ta70°C/B
 Cul-Gewicht: 110 g
 Gesamt-Gewicht: 286 g

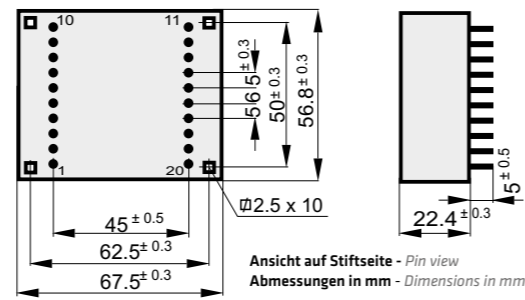

Nennleistung/Nominal power

10.0 VA

Safety transformer
 VDE 0570 / EN 61558 / ENEC10
 UL 506 / CSA approved
 Vacuum casting
 Temperature class ta70°C/B
 Cul weight: 110 g
 Total weight: 286 g



Bestell Nr. <i>Order No.</i>	Primär [V] <i>Primary</i>	Sekundär [V] <i>Secondary</i>	Strom [mA] <i>Current</i>	Stiftbelegung <i>Pin configuration</i>	Leerlaufspannung [V] <i>No load voltage</i>	Prüfzeichen / Approvals		
						VDE	5085-2/3	5085-1/2
FLG39.8/60037-1	2x115	2x6	2x833	1-4+7-10 / 11-13+18-20	2x7,70	●		●
FLG39.8/60071-1	2x115	2x7,5	2x666	1-4+7-10 / 11-13+18-20	2x9,60	●		●
FLG39.8/60016-1	2x115	2x9	2x555	1-4+7-10 / 11-13+18-20	2x11,50	●		●
FLG39.8/60017-1	2x115	2x12	2x416	1-4+7-10 / 11-13+18-20	2x15,10	●		●
FLG39.8/60018-1	2x115	2x15	2x333	1-4+7-10 / 11-13+18-20	2x18,90	●		●
FLG39.8/60038-1	2x115	2x18	2x277	1-4+7-10 / 11-13+18-20	2x22,70	●		●
FLG39.8/60072-1	2x115	2x24	2x208	1-4+7-10 / 11-13+18-20	2x29,60	●		●

Trenntransformator / isolation transformer

Typ/Type

UI39/10,2

Sicherheitstransformator
 VDE 0570 / EN 61558 / ENEC10
 UL 506 / CSA geprüft
 Vakuumverguss
 Temperaturklasse ta70°C/B
 Cul-Gewicht: 130 g
 Gesamt-Gewicht: 320 g

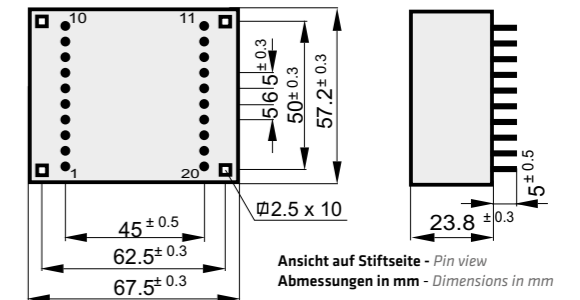

Nennleistung/Nominal power

14.0 VA

Safety transformer
 VDE 0570 / EN 61558 / ENEC10
 UL 506 / CSA approved
 Vacuum casting
 Temperature class ta70°C/B
 Cul weight: 130 g
 Total weight: 320 g



Bestell Nr. <i>Order No.</i>	Primär [V] <i>Primary</i>	Sekundär [V] <i>Secondary</i>	Strom [mA] <i>Current</i>	Stiftbelegung <i>Pin configuration</i>	Leerlaufspannung [V] <i>No load voltage</i>	Prüfzeichen / Approvals		
						VDE	5085-2/3	5085-1/2
FLG39.10/60042-1	2x115	2x6	2x1166	1-4+7-10 / 11-13+18-20	2x7,50	●		●
FLG39.10/60043-1	2x115	2x7,5	2x933	1-4+7-10 / 11-13+18-20	2x9,10	●		●
FLG39.10/60019-1	2x115	2x9	2x777	1-4+7-10 / 11-13+18-20	2x11,00	●		●
FLG39.10/60020-1	2x115	2x12	2x583	1-4+7-10 / 11-13+18-20	2x15,60	●		●
FLG39.10/60021-1	2x115	2x15	2x466	1-4+7-10 / 11-13+18-20	2x18,90	●		●
FLG39.10/60044-1	2x115	2x18	2x388	1-4+7-10 / 11-13+18-20	2x22,70	●		●
FLG39.10/60073-1	2x115	2x24	2x291	1-4+7-10 / 11-13+18-20	2x29,40	●		●

Trenntransformator / isolation transformer

Typ/Type

UI39/13,5

Sicherheitstransformator
 VDE 0570 / EN 61558 / ENEC10
 UL 506 / CSA geprüft
 Vakuumverguss
 Temperaturklasse ta70°C/B
 Cul-Gewicht: 130 g
 Gesamt-Gewicht: 375 g

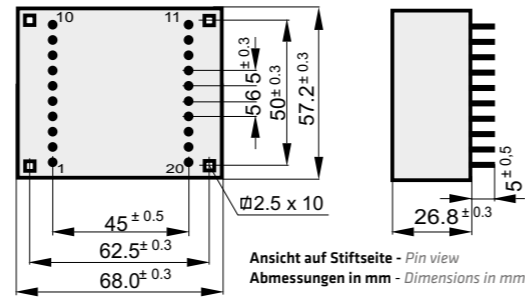

Nennleistung/Nominal power

18.0 VA

Safety transformer
 VDE 0570 / EN 61558 / ENEC10
 UL 506 / CSA approved
 Vacuum casting
 Temperature class ta70°C/B
 Cul weight: 130 g
 Total weight: 375 g



Bestell Nr. <i>Order No.</i>	Primär [V] <i>Primary</i>	Sekundär [V] <i>Secondary</i>	Strom [mA] <i>Current</i>	Stiftbelegung <i>Pin configuration</i>	Leerlaufspannung [V] <i>No load voltage</i>	Prüfzeichen / Approvals		
						VDE	5085-2/3	5085-1/2
FLG39.13/60046-1	2x115	2x6	2x1500	1-4+7-10 / 11-13+18-20	2x7,30	●		●
FLG39.13/60076-1	2x115	2x7,5	2x1200	1-4+7-10 / 11-13+18-20	2x9,10	●		●
FLG39.13/60022-1	2x115	2x9	2x1000	1-4+7-10 / 11-13+18-20	2x11,30	●		●
FLG39.13/60023-1	2x115	2x12	2x750	1-4+7-10 / 11-13+18-20	2x14,60	●		●
FLG39.13/60024-1	2x115	2x15	2x600	1-4+7-10 / 11-13+18-20	2x17,90	●		●
FLG39.13/60061-1	2x115	2x18	2x500	1-4+7-10 / 11-13+18-20	2x21,60	●		●
FLG39.13/60077-1	2x115	2x24	2x375	1-4+7-10 / 11-13+18-20	2x28,50	●		●

Trenntransformator / isolation transformer

Typ/Type

UI39/17

Sicherheitstransformator
 VDE 0570 / EN 61558 / ENEC10
 UL 506 / CSA geprüft
 Vakuumverguss
 Temperaturklasse ta70°C/B
 Cul-Gewicht: 140 g
 Gesamt-Gewicht: 445 g

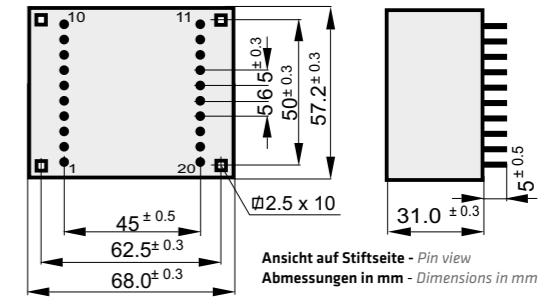

Nennleistung/Nominal power

24.0 VA

Safety transformer
 VDE 0570 / EN 61558 / ENEC10
 UL 506 / CSA approved
 Vacuum casting
 Temperature class ta70°C/B
 Cul weight: 140 g
 Total weight: 445 g



Bestell Nr. <i>Order No.</i>	Primär [V] <i>Primary</i>	Sekundär [V] <i>Secondary</i>	Strom [mA] <i>Current</i>	Stiftbelegung <i>Pin configuration</i>	Leerlaufspannung [V] <i>No load voltage</i>	Prüfzeichen / Approvals		
						VDE	5085-2/3	5085-1/2
FLG39.17/60049-1	2x115	2x6	2x2000	1-4+7-10 / 11-13+18-20	2x7,30	●		●
FLG39.17/60050-1	2x115	2x7,5	2x1600	1-4+7-10 / 11-13+18-20	2x9,10	●		●
FLG39.17/60025-1	2x115	2x9	2x1333	1-4+7-10 / 11-13+18-20	2x10,80	●		●
FLG39.17/60026-1	2x115	2x12	2x1000	1-4+7-10 / 11-13+18-20	2x14,50	●		●
FLG39.17/60027-1	2x115	2x15	2x800	1-4+7-10 / 11-13+18-20	2x18,20	●		●
FLG39.17/60060-1	2x115	2x18	2x666	1-4+7-10 / 11-13+18-20	2x21,70	●		●
FLG39.17/60051-1	2x115	2x24	2x500	1-4+7-10 / 11-13+18-20	2x28,50	●		●

Trenntransformator / isolation transformer

Typ/Type

UI39/21

Sicherheitstransformator
 VDE 0570 / EN 61558 / ENEC10
 UL 506 / CSA geprüft
 Vakuumverguss
 Temperaturklasse ta70°C/B
 Cul-Gewicht: 170 g
 Gesamt-Gewicht: 535 g

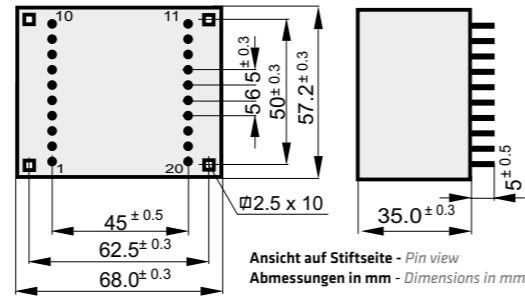

Nennleistung/Nominal power

30.0 VA

Safety transformer
 VDE 0570 / EN 61558 / ENEC10
 UL 506 / CSA approved
 Vacuum casting
 Temperature class ta70°C/B
 Cul weight: 170 g
 Total weight: 535 g



Bestell Nr. <i>Order No.</i>	Primär [V] <i>Primary</i>	Sekundär [V] <i>Secondary</i>	Strom [mA] <i>Current</i>	Stiftbelegung <i>Pin configuration</i>	Leerlaufspannung [V] <i>No load voltage</i>	Prüfzeichen / Approvals		
						VDE	5085-2/3	5085-1/2
FLG39.21/60052-1	2x115	2x6	2x2500	1-4+7-10 / 11-13+18-20	2x6,70	●		●
FLG39.21/60053-1	2x115	2x7,5	2x2000	1-4+7-10 / 11-13+18-20	2x8,60	●		●
FLG39.21/60028-1	2x115	2x9	2x1666	1-4+7-10 / 11-13+18-20	2x10,60	●		●
FLG39.21/60029-1	2x115	2x12	2x1250	1-4+7-10 / 11-13+18-20	2x13,90	●		●
FLG39.21/60030-1	2x115	2x15	2x1000	1-4+7-10 / 11-13+18-20	2x17,30	●		●
FLG39.21/60054-1	2x115	2x18	2x833	1-4+7-10 / 11-13+18-20	2x20,90	●		●
FLG39.21/60055-1	2x115	2x24	2x625	1-4+7-10 / 11-13+18-20	2x27,30	●		●

Trenntransformator / isolation transformer

Typ/Type

UI48/17

Sicherheitstransformator
 VDE 0570 / EN 61558 / ENEC10
 UL 506 / CSA geprüft
 Vakuumverguss
 Temperaturklasse ta70°C/B
 Cul-Gewicht: 170 g
 Gesamt-Gewicht: 800 g

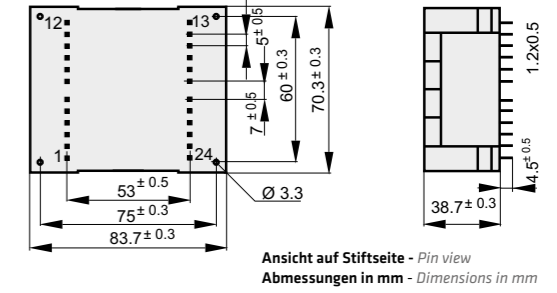

Nennleistung/Nominal power

40.0 VA

Safety transformer
 VDE 0570 / EN 61558 / ENEC10
 UL 506 / CSA approved
 Vacuum casting
 Temperature class ta70°C/B
 Cul weight: 170 g
 Total weight: 800 g



Bestell Nr. <i>Order No.</i>	Primär [V] <i>Primary</i>	Sekundär [V] <i>Secondary</i>	Strom [mA] <i>Current</i>	Stiftbelegung <i>Pin configuration</i>	Leerlaufspannung [V] <i>No load voltage</i>	Prüfzeichen / Approvals		
						VDE	5085-2/3	5085-1/2
FLG48.17/60608	2x115	2x6	2x3333	1-4+9-12 / 14-17+20-23	2x6,75	●		●
FLG48.17/60609	2x115	2x9	2x2222	1-4+9-12 / 14-17+20-23	2x10,20	●		●
FLG48.17/60610	2x115	2x12	2x1666	1-4+9-12 / 14-17+20-23	2x13,70	●		●
FLG48.17/60611	2x115	2x15	2x1333	1-4+9-12 / 14-17+20-23	2x17,20	●		●
FLG48.17/60612	2x115	2x18	2x1111	1-4+9-12 / 14-17+20-23	2x20,60	●		●

Typ/Type

UI48/17

Sicherheitstransformator
nach VDE 0570 / EN 61558
UL 506 / CSA
Vakuumverguss
Temperaturklasse ta40°C/B
Cul-Gewicht: 170 g
Gesamt-Gewicht: 800 g

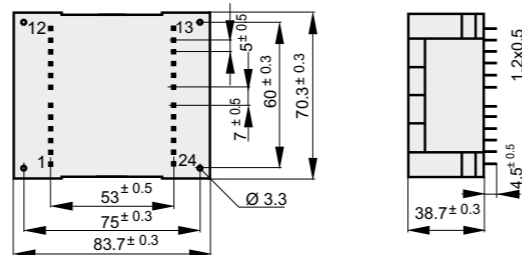

Ansicht auf Stiftseite - Pin view
Abmessungen in mm - Dimensions in mm

Nennleistung/Nominal power

45.0 VA

Safety transformer
according to VDE 0570 / EN 61558
UL 506 / CSA
Vacuum casting
Temperature class ta40°C/B
Cul weight: 170 g
Total weight: 800 g



Bestell Nr. <i>Order No.</i>	Primär [V] <i>Primary</i>	Sekundär [V] <i>Secondary</i>	Strom [mA] <i>Current</i>	Stiftbelegung <i>Pin configuration</i>	Leerlaufspannung [V] <i>No load voltage</i>	Prüfzeichen / Approvals		
						VDE	5085-2/3	5085-1/2
FLG48.17/60613	2x115	2x6	2x3750	1-4+9-12 / 14-17+20-23	2x6,60			●
FLG48.17/60614	2x115	2x9	2x2500	1-4+9-12 / 14-17+20-23	2x9,85			●
FLG48.17/60615	2x115	2x12	2x1875	1-4+9-12 / 14-17+20-23	2x13,10			●
FLG48.17/60616	2x115	2x15	2x1500	1-4+9-12 / 14-17+20-23	2x16,40			●
FLG48.17/60617	2x115	2x18	2x1250	1-4+9-12 / 14-17+20-23	2x19,90			●

Typ/Type

UI48/26

Sicherheitstransformator
VDE 0570 / EN 61558 / ENEC10 geprüft
Vakuumverguss
Temperaturklasse ta70°C/B
Cul-Gewicht: 0,190 kg
Gesamt-Gewicht: 1,10 kg

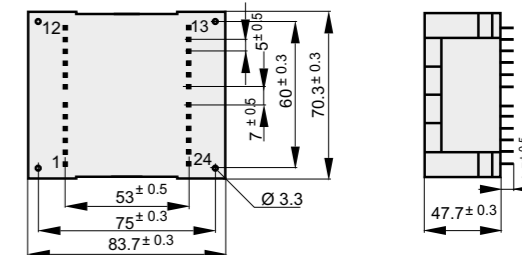

Ansicht auf Stiftseite - Pin view
Abmessungen in mm - Dimensions in mm

Nennleistung/Nominal power

60.0 VA

Safety transformer
VDE 0570 / EN 61558 / ENEC10 approved
Vacuum casting
Temperature class ta70°C/B
Cul weight: 0,190 kg
Total weight: 1,10 kg



Bestell Nr. <i>Order No.</i>	Primär [V] <i>Primary</i>	Sekundär [V] <i>Secondary</i>	Strom [mA] <i>Current</i>	Stiftbelegung <i>Pin configuration</i>	Leerlaufspannung [V] <i>No load voltage</i>	Prüfzeichen / Approvals		
						VDE	5085-2/3	5085-1/2
FLG48.26/60618	2x115	2x6	2x5000	1-4+9-12 / 14-17+20-23	2x6,80	●		●
FLG48.26/60619	2x115	2x9	2x3333	1-4+9-12 / 14-17+20-23	2x10,20	●		●
FLG48.26/60620	2x115	2x12	2x2500	1-4+9-12 / 14-17+20-23	2x13,55	●		●
FLG48.26/60621	2x115	2x15	2x2000	1-4+9-12 / 14-17+20-23	2x16,95	●		●
FLG48.26/60622	2x115	2x18	2x1666	1-4+9-12 / 14-17+20-23	2x20,22	●		●

Typ/Type

UI48/26

Sicherheitstransformator
nach VDE 0570 / EN 61558
UL 506 / CSA
Vakuumverguss
Temperaturklasse ta40°C/B
Cul-Gewicht: 0,190 kg
Gesamt-Gewicht: 1,10 kg

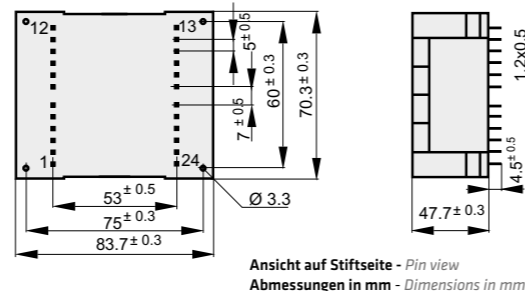

Nennleistung/Nominal power

65.0 VA

Safety transformer
according to VDE 0570 / EN 61558
UL 506 / CSA
Vacuum casting
Temperature class ta40°C/B
Cul weight: 0,190 kg
Total weight: 1,10 kg



Bestell Nr. <i>Order No.</i>	Primär [V] <i>Primary</i>	Sekundär [V] <i>Secondary</i>	Strom [mA] <i>Current</i>	Stiftbelegung <i>Pin configuration</i>	Leerlaufspannung [V] <i>No load voltage</i>	Prüfzeichen / Approvals		
						VDE	5085-2/3	5085-1/2
FLG48.26/60623	2x115	2x6	2x5417	1-4+9-12 / 14-17+20-23	2x6,50			●
FLG48.26/60624	2x115	2x9	2x3611	1-4+9-12 / 14-17+20-23	2x10,10			●
FLG48.26/60625	2x115	2x12	2x2708	1-4+9-12 / 14-17+20-23	2x13,00			●
FLG48.26/60626	2x115	2x15	2x2167	1-4+9-12 / 14-17+20-23	2x16,95			●
FLG48.26/60627	2x115	2x18	2x1806	1-4+9-12 / 14-17+20-23	2x19,90			●



Entscheidende Vorteile unserer Transformatoren mit speziellen Abmessungen:

- kompakte Bauweise mit einem Leistungsbereich bis 220 VA
- optimale Bauhöhe für den Einsatz auf Leiterplatten
- maximale Ausnutzung des Platzangebotes durch Einsatz von Kernblechen mit langem Schenkel
- nicht kurzschlussfest oder bedingt kurzschlussfest mit integrierter Temperatursicherung
- ausgezeichnetes Temperaturwechselverhalten durch Vakuumverguss
- Absicherung extern durch PTC möglich
- 100% stückgeprüft mit 4000 V PRI-SEC
- Temperatur-, Isolierstoffklasse ta 40°C/B, ta 70°C/B
- höchste Sicherheit und Langlebigkeit
- VDE-, UL-, CSA-, ENEC10-Prüfzeichen
- fester Sitz auf der Leiterplatte durch zusätzliche Befestigungsmöglichkeiten
- Zweikammer-Wicklung
- hohe Stoßspannungsfestigkeit
- selbstverlöschendes Haubenmaterial

Key advantages of our transformers with special dimensions:

- compact design with power range up to 220 VA
- optimal height for installation on PCB boards
- maximum use of the space given by using laminations with a long bracket
- non short circuit proof or conditionally short circuit proof with internal thermal fuse
- excellent temperature-change behavior owing to vacuum casting
- secondary protection by means of external PTC resistances possible
- 100% unit checked with 4000 V PRI-SEC
- ambient temperature insulation class ta 40°C/B, ta 70°C/B
- highest safety and lifetime
- VDE, UL, CSA, ENEC10 approvals
- snug fit on PCB through additional fixing
- split bobbin, two chamber winding
- high surge capability
- self-extinguishing case material

Aufgrund der umfangreichen Variationsmöglichkeiten können wir in diesem Katalog nur einen Teilbereich abdecken. Wir sind spezialisiert auf kundenspezifische Lösungen und freuen uns daher auf Ihre Anfrage.

Due to the wide range of optionally available variants, this catalog can cover only a part of our total product range. We are specialized on customized solutions and look forward to your inquiry.

Typ/Type

EE25/7,7

Sicherheitstransformator / Kurzschlußfest
nach VDE 0570 / EN 61558
UL 506 / CSA
Vakuummverguss
Temperaturklasse ta70°C/B
Cul-Gewicht: 8 g
Gesamt-Gewicht: 50 g

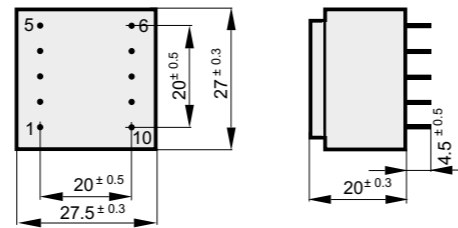

Ansicht auf Stiftseite - Pin view
Abmessungen in mm - Dimensions in mm

Nennleistung/Nominal power

0.8 VA

Safety transformer / Short-circuit-proof
according to VDE 0570 / EN 61558
UL 506 / CSA
Vacuum casting
Temperature class ta70°C/B
Cul weight: 8 g
Total weight: 50 g



Bestell Nr. <i>Order No.</i>	Primär [V] <i>Primary</i>	Sekundär [V] <i>Secondary</i>	Strom [mA] <i>Current</i>	Stiftbelegung <i>Pin configuration</i>	Leerlaufspannung [V] <i>No load voltage</i>	Prüfzeichen / Approvals		
						VDE	5085-2/3	5085-1/2
VN25.7/09404	230	12	66	1-5 / 7-9	18,50			●
VN25.7/09357	230	2x12	2x33	1-5 / 6-7 + 9-10	20,48 / 21,75			●

Spezifische Kundenwünsche auf Anfrage gerne möglich (z.B. Leistung / Spannung / Stiftbelegung)
Customized versions optionally available upon request (e. g. power / voltages / pinning)

Typ/Type

E30/40

Sicherheitstransformator
nach VDE 0570 / EN 61558
UL 506 / CSA
Vakuummverguss
Temperaturklasse ta70°C/B

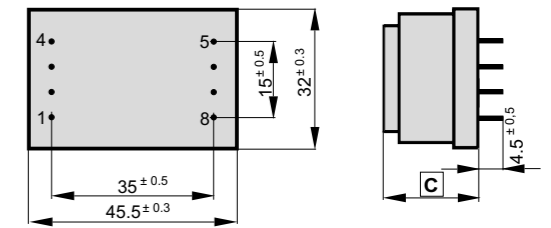

Ansicht auf Stiftseite - Pin view
Abmessungen in mm - Dimensions in mm

Nennleistung/Nominal power

1.4-10 VA

Safety transformer
according to VDE 0570 / EN 61558
UL 506 / CSA
Vacuum casting
Temperature class ta70°C/B



Bestell Nr. <i>Order No.</i>	Primär [V] <i>Primary</i>	Sekundär [V] <i>Secondary</i>	Strom [mA] <i>Current</i>	Stiftbelegung <i>Pin configuration</i>	Einbauhöhe [mm] - C - <i>installation height</i>	Leistung [VA] <i>power</i>	Gewicht / Weight		Prüfzeichen APPROVALS 5085-1/2
							Cul	Gesamt - g - Total	
FLG/F30.5/40016	230	12	117	1-4 / 6-7	16,20	1,4	20	50	●
FLG/F30.7/09409	230	12	183	1-4 / 6-7	18,10	2,2	21	70	●
FLG/F30.10/40017	230	12	250	1-4 / 6-7	21,00	3,0	23	100	
FLG/F30.16/40018	230	12	408	1-4 / 6-7	26,80	4,9	28	160	
FLG/F30.26/40019	230	12	667	1-4 / 6-7	36,70	8,0	38	250	
FLG/F30.5/40020	230	12	125	1-4 / 6-7	16,20	1,5	20	50	
FLG/F30.7/40021	230	12	208	1-4 / 6-7	18,10	2,5	21	70	
FLG/F30.10/40022	230	12	308	1-4 / 6-7	21,00	3,7	23	100	
FLG/F30.16/40023	230	12	500	1-4 / 6-7	26,80	6,0	28	160	
FLG/F30.26/40024	230	12	833	1-4 / 6-7	36,70	10,0	38	250	●

Spezifische Kundenwünsche auf Anfrage gerne möglich (z.B. Leistung / Spannung / Stiftbelegung)
Customized versions optionally available upon request (e. g. power / voltage / pinning)

Typ/Type

EI54/72

Sicherheitstransformator
nach VDE 0570 / EN 61558
UL 506 / CSA
Vakuumverguss
Temperaturklasse ta40°C/B

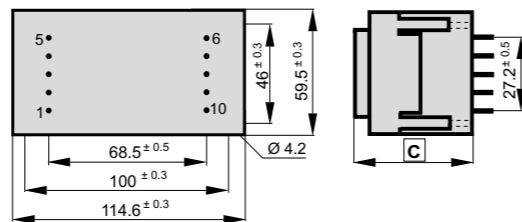

Ansicht auf Stiftseite - Pin view
Abmessungen in mm - Dimensions in mm

Nennleistung/Nominal power

30-45 VA

Safety transformer
according to VDE 0570 / EN 61558
UL 506 / CSA
Vacuum casting
Temperature class ta40°C/B



Bestell Nr. <i>Order No.</i>	Primär [V] <i>Primary</i>	Sekundär [V] <i>Secondary</i>	Strom [A] <i>Current</i>	Stiftbelegung <i>Pin configuration</i>	Einbauhöhe [mm] - C - <i>installation height</i>	Leistung [VA] <i>power</i>	Gewicht / Weight <i>Cul Gesamt</i> <i>Cul Total</i>		Prüfzeichen APPROVALS 5085-1/2
VF54/72.18/17554	230	12	2,50	1-5 / 7-9	43,00	30	180	700	●
VF54/72.32/17555	230	12	3,75	1-5 / 7-9	57,00	45	220	1150	●

Typ/Type

EI66/88

Sicherheitstransformator
nach VDE 0570 / EN 61558
UL 506 / CSA
Vakuumverguss
Temperaturklasse ta40°C/B

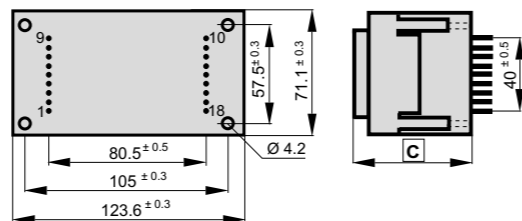

Ansicht auf Stiftseite - Pin view
Abmessungen in mm - Dimensions in mm

Nennleistung/Nominal power

60-90 VA

Safety transformer
according to VDE 0570 / EN 61558
UL 506 / CSA
Vacuum casting
Temperature class ta40°C/B



Bestell Nr. <i>Order No.</i>	Primär [V] <i>Primary</i>	Sekundär [V] <i>Secondary</i>	Strom [A] <i>Current</i>	Stiftbelegung <i>Pin configuration</i>	Einbauhöhe [mm] - C - <i>installation height</i>	Leistung [VA] <i>power</i>	Gewicht / Weight <i>Cul Gesamt</i> <i>Cul Total</i>		Prüfzeichen APPROVALS 5085-1/2
VF66/88.18/19398	230	12	5,0	1-9 / 12-18	49,1	60	300	1250	●
VF66/88.34/19399	230	12	7,5	1-9 / 12-18	63,7	90	400	1650	●

Spezifische Kundenwünsche auf Anfrage gerne möglich (z.B. Leistung / Spannung / Stiftbelegung)

Customized versions optionally available upon request (e. g. power / voltage / pinning)

Typ/Type

EI84/112

Sicherheitstransformator
nach VDE 0570 / EN 61558
UL 506 / CSA
Vakuumverguss
Temperaturklasse ta40°C/B

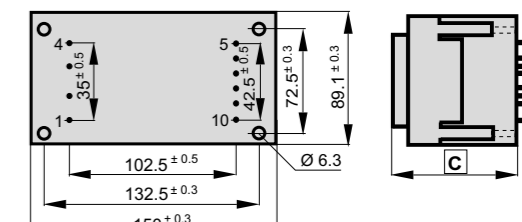

Ansicht auf Stiftseite - Pin view
Abmessungen in mm - Dimensions in mm

Nennleistung/Nominal power

150-220 VA

Safety transformer
according to VDE 0570 / EN 61558
UL 506 / CSA
Vacuum casting
Temperature class ta40°C/B



Bestell Nr. <i>Order No.</i>	Primär [V] <i>Primary</i>	Sekundär [V] <i>Secondary</i>	Strom [A] <i>Current</i>	Stiftbelegung <i>Pin configuration</i>	Einbauhöhe [mm] - C - <i>installation height</i>	Leistung [VA] <i>power</i>	Gewicht / Weight <i>Cul Gesamt</i> <i>Cul Total</i>		Prüfzeichen APPROVALS 5085-1/2
VF84/112.29/04359	230	12	12,50	1-5 / 7-9	67,10	150	670	2500	●
VF84/112.43/04360	230	12	18,33	1-5 / 7-9	81,10	220	775	3500	●

Spezifische Kundenwünsche auf Anfrage gerne möglich (z.B. Leistung / Spannung / Stiftbelegung)

Customized versions optionally available upon request (e. g. power / voltage / pinning)



Entscheidende Vorteile unserer Ringkern-Transformatoren:

- Reduzierung des Volumens: mit Befestigungswinkeln und Klemmen bis zu 50% Platzeinsparung möglich
- Reduzierung des Gewichtes: durch gleichmäßige Verteilung der Wicklung geringerer Kupfereinsatz und geringeres Gewicht
- Höherer Wirkungsgrad: durch Einsatz von besonders hochwertigem Kernblech ist ein bis zu 50% geringerer Materialeinsatz möglich
- Energieeinsparung: Leerlaufverluste sind 40 - 70%, Verluste unter Last ca. 10 - 30% geringer
- Flexible Montage:
 - kostengünstige Standardbefestigung durch Zentralschraube
 - komplett vergossen im Kunststoff- oder Metallgehäuse
 - Printmontage
 - druckfreie Befestigungsplatte
- Reduzierung der Brummgeräusche: keine Vibration, da hochwertiges kororientiertes Transformatorenblech aus gewickeltem Endlosband mit verschweißtem Bandanfang und -ende eingesetzt wird
- Keine Luftspalte und lose Bleche bzw. Lamellen
- Geringeres magnetisches Streufeld: Reduzierung um ca. 80% und somit weniger Störungen

Key advantages of our toroidal-transformers:

- *Reduction of the volume: with mounting brackets and clamps space saving of up to 50% possible*
- *Reduction of weight: through uniform distribution of the winding reduced use of copper and lower weight*
- *Increased efficiency: through the use of particularly high quality core plates, a material reduction of up to 50% is possible*
- *Energy savings: No-load losses are 40 - 70% lower, losses at load approximately 10 - 30% lower*
- *Flexible mounting:*
 - *Cost-effective standard mounting by central screw*
 - *Completely encapsulated in plastic or metal housing*
 - *PCB mounting*
 - *Pressure-free mounting plate*
- *Reduction of humming: no vibration, because wound high quality grain-oriented endless steel belt tape is welded at the beginning and the end*
- *No air gaps and loose sheets or lamination*
- *Reduced magnetic stray field: Reduction by approximately 80% and thus less interference*

Sämtliche Baugrößen können wir nach Kundenwunsch anpassen:

- weitere PRI-SEC-Spannungen
- individuelle Leistungen von 20 - 5.000 VA
- vergossene Ausführungen
- individuelle Anschlüsse (Flachsteckerzungen, Reihenklammern oder konfektionierte Anschlüsse)
- Montage mittels zweier flexibler Isolierscheiben, einer Metallplatte oder Zentralbefestigungsschraube möglich
- umfangreiche UL-Zertifikate

Customization of all sizes is possible:

- further PRI-SEC voltages
- different power values from 20 - 5,000 VA
- potted versions
- different connections (flat blade terminals, terminal strips or ready-for-use terminals)
- mounting with two flexible seal grommets, a metal plate or central fixing screw is possible
- wide range of UL certificates

Typ/Type

R88-R128

Sicherheitstransformator / Kurzschlußfest nach EN 61558 / UL 506 / CSA
 Temperaturklasse ta70°C/B
 IP00
 Thermosicherung 120°C
 Klasse B
 freie Enden 130 mm Länge

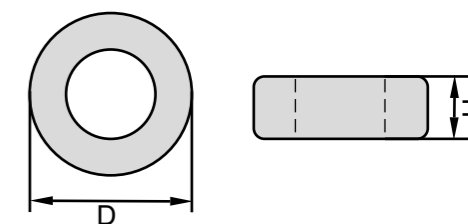

Nennleistung/Nominal power

50-500 VA

Safety transformer / Short-circuit-proof according to EN 61558 / UL 506 / CSA
 Temperature class ta70°C/B
 IP00
 Thermal fuse 120°C
 Class B
 Free ending 130 mm length



Bestell Nr. <i>Order No.</i>	Primär [V] <i>Primary</i>	Sekundär [V] <i>Secondary</i>	Strom [A] <i>Current</i>	Leistung [VA] <i>Power</i>	Abmessungen [mm] D / H <i>dimensions</i>	Prüfzeichen / Approvals		
						NEMKO	5085-2/3	5085-1/2
R88.36/05038	230	12	4,20	50	88 / 36	●	●	
R93.38/05039	230	12	5,00	60	93 / 38	●	●	
R101.38/05040	230	12	6,70	80	101 / 38	●	●	
R110.40/05041	230	12	8,40	100	110 / 40	●	●	
R112.43/05042	230	12	10,00	120	112 / 43	●		●
R101.48/05043	230	12	12,50	150	101 / 48	●		●
R120.48/05044	230	12	15,00	180	120 / 48	●		●
R103.53/05045	230	12	16,70	200	103 / 53	●		●
R108.54/05046	230	12	20,90	250	108 / 54	●		●
R113.55/05047	230	12	25,00	300	113 / 55	●		●
R119.55/05048	230	12	33,40	400	119 / 55			●
R128.60/05049	230	12	41,70	500	128 / 60			●

Spezifische Kundenwünsche auf Anfrage gerne möglich (z.B. Kabel mit Stecker)

Customized versions optionally available upon request (e. g. wire with connector)



Eigenschaften unserer Steuer-Transformatoren:

Steuer-Transformatoren sind Transformatoren mit galvanisch getrennten Wicklungen zur Speisung von elektrischen Steuer- und Meldestromkreisen. Sie finden ihren Einsatz im Steuerungsbau, in Stromversorgungsgeräten und vor allem in Schaltungen, die eine Netztrennung erfordern. Aufgrund der Fußwinkelbefestigung und dem Anschluss über Reihenklemmen sind sie für den Einbau in der Steuerungstechnik geeignet.

Vorteile:

- Betriebsspannung für Steuer- und Hilfsstromkreise an den weltweit verschiedenen Netzspannungen wird jederzeit funktionssicher gewährleistet
- höhere Funktionssicherheit von elektrischen Anlagen durch serienmäßige Zusatzanzapfungen von ± 5 %
- kompakte Bauweise mit einem Leistungsbereich bis 1.500 VA
- Befestigung mit Fußwinkel oder Rastfuß für Hutschienen
- geerdeter oder ungeerdeter Betrieb wählbar
- geringer Spannungsabfall beim Schalten induktiver Lasten
- Dämpfung leitungsgebundener Störungen vom Hauptstromkreis
- Begrenzung des Kurzschlussstromes im Steuerstromkreis
- einfache Spannungs- und Isolationsprüfung
- Aufbau gemäss VDE 0570 Teil 2-2 (EN 61558-2-2)

Features of our control-transformers:

Control-transformers are transformers with galvanically separated windings for the feed of electric control and indicating circuits. They are applied in control system construction, in power supply devices and mainly in circuits, which require disconnection from power supply. Since they are mounted with base angles and equipped with terminal strip connection, they are appropriate for use in control engineering.

Advantages:

- operating voltage for control and auxiliary circuits at worldwide varying power supply voltages is always guaranteed with functional safety
- higher functional safety of electrical systems through serial additional tapplings of ± 5 %
- compact design with power range up to 1,500 VA
- fixing with base angle or click-stop device for cap rails
- selection between grounded or ungrounded operation
- low voltage drop when switching inductive loads
- damping of line-bound interferences from the main circuit
- limiting of the short-circuit current in the control circuit
- easy voltage and insulation test
- design according to VDE 0570 part 2-2 (EN 61558-2-2)

Sämtliche Baugrößen können wir nach Kundenwunsch anpassen:

- weitere PRI-SEC-Spannungen
- individuelle Leistungen
- höhere Temperaturklassen
- spezielle Klemmen (Zugfeder- bzw. Schraubklemmen, Kombifußplatte für Schraub- und Tragschielenmontage, Klemmen mit Schraub- und Steckanschluss)

Customization of all sizes is possible:

- further PRI-SEC voltages
- individual power values
- higher temperature classes
- special clamps (extension spring clamps or screw-type clamps, multi-function base plate for installation with threaded fastener or carrier rail, clamps with screw-type and plug-in connection)

Typ/Type

EI84

Steuertransformator nach VDE 0570 / EN 61558
Vakuumgetränkt
Temperaturklasse ta40°C/B

Offener getränkter Transformator
getrennte Wicklungen
Fußwinkel zur Befestigung
Klemm- und Steckanschluss
6,3 oder 2 x 2,8 mm,
Vorbereitet für Schutzklasse I

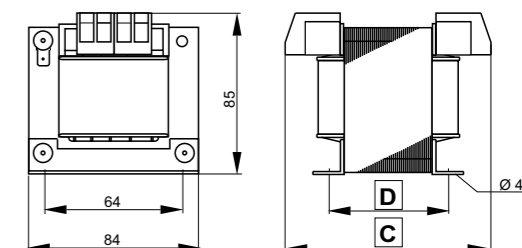

Abmessungen in mm - Dimensions in mm

Nennleistung/Nominal power

63-100 VA

Control transformer according to VDE 0570 / EN 61558
Vacuum impregnated
Temperature class ta40°C/B

open type, impregnated transformer
separate windings
base angles for fixing
terminals for clamp or plug-in connection
6,3 or 2 x 2,8 mm,
prepared for safety class I



Bestell Nr.	Primär [V]	Sekundär [V]	Strom [A]	Ausführung	Einbaumaße [mm]			Leistung [VA]	Cul - Gewicht [g]	ges. Gewicht [g]
Order No.	Primary	Secondary	Current	version	C	I	D	power	Cul-weight	Total-weight
ST84.29/04330	230 ±5%	24	2,63	Klemmen /clamps	88	48	63	400	2100	
ST84.43/04331	230 ±5%	24	4,17	Klemmen /clamps	102	62	100	450	2500	

Typ/Type

EI96

Steuertransformator nach VDE 0570 / EN 61558
Vakuumgetränkt
Temperaturklasse ta40°C/B

Offener getränkter Transformator
getrennte Wicklungen
Fußwinkel zur Befestigung
Klemm- und Steckanschluss
6,3 oder 2 x 2,8 mm,
Vorbereitet für Schutzklasse I

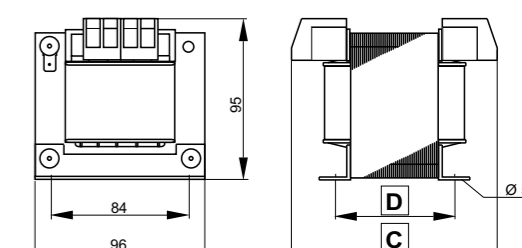

Abmessungen in mm - Dimensions in mm

Nennleistung/Nominal power

130 VA

Control transformer according to VDE 0570 / EN 61558
Vacuum impregnated
Temperature class ta40°C/B

open type, impregnated transformer
separate windings
base angles for fixing
terminals for clamp or plug-in connection
6,3 or 2 x 2,8 mm,
prepared for safety class I



Bestell Nr.	Primär [V]	Sekundär [V]	Strom [A]	Ausführung	Einbaumaße [mm]			Leistung [VA]	Cul - Gewicht [g]	ges. Gewicht [g]
Order No.	Primary	Secondary	Current	version	C	I	D	power	Cul-weight	Total-weight
ST96.35/53013	230 ±5%	24	5,42	Klemmen /clamps	96	61	130	450	2800	

Spezifische Kundenwünsche auf Anfrage gerne möglich (z.B. Leistung / Spannung / Rastfuß)
Customized versions optionally available upon request (e. g. power / voltage / click stop device)

Typ/Type

EI105

Steuertransformator
nach VDE 0570 / EN 61558
Vakuumgetränkt
Temperaturklasse ta40°C/B

Offener getränkter Transformator
getrennte Wicklungen
Fusswinkel zur Befestigung
Klemm- und Steckanschluss
6,3 oder 2 x 2,8 mm,
Vorbereitet für Schutzklasse I

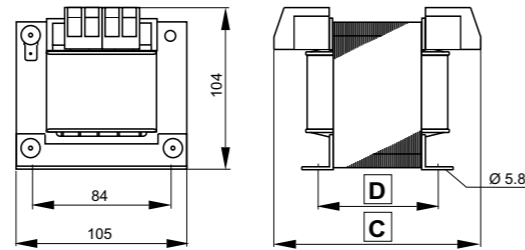

Abmessungen in mm - Dimensions in mm

Nennleistung/Nominal power

160 VA

Control transformer
according to VDE 0570 / EN 61558
Vacuum impregnated
Temperature class ta40°C/B

open type, impregnated transformer
separate windings
base angles for fixing
terminals for clamp or plug-in connection
6,3 or 2 x 2,8 mm,
prepared for safety class I



Bestell Nr.	Primär [V]	Sekundär [V]	Strom [A]	Ausführung	Einbaumaße [mm]		Leistung [VA]	Cul - Gewicht [g]	ges. Gewicht [g]
Order No.	Primary	Secondary	Current	version	C	I D	power	Cul-weight	Total-weight

ST105.37/04447	230 ±5%	24	6,67	Klemmen /clamps	95	61	160	800	4000
----------------	---------	----	------	-----------------	----	----	-----	-----	------

Typ/Type

EI120

Steuertransformator
nach VDE 0570 / EN 61558
Vakuumgetränkt
Temperaturklasse ta40°C/B

Offener getränkter Transformator
getrennte Wicklungen
Fusswinkel zur Befestigung
Klemm- und Steckanschluss
6,3 oder 2 x 2,8 mm,
Vorbereitet für Schutzklasse I

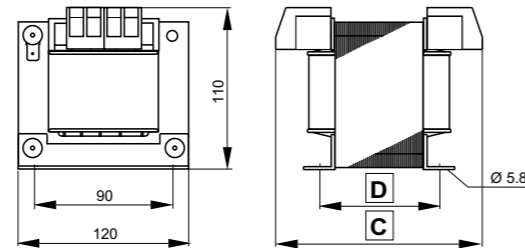

Abmessungen in mm - Dimensions in mm

Nennleistung/Nominal power

250-400 VA

Control transformer
according to VDE 0570 / EN 61558
Vacuum impregnated
Temperature class ta40°C/B

open type, impregnated transformer
separate windings
base angles for fixing
terminals for clamp or plug-in connection
6,3 or 2 x 2,8 mm,
prepared for safety class I



Bestell Nr.	Primär [V]	Sekundär [V]	Strom [A]	Ausführung	Einbaumaße [mm]		Leistung [VA]	Cul - Gewicht [g]	ges. Gewicht [g]
Order No.	Primary	Secondary	Current	version	C	I D	power	Cul-weight	Total-weight

ST120.41/04636	230 ±5%	24	10,42	Klemmen /clamps	99,5	68,5	250	1000	4000
ST120.53/04637	230 ±5%	24	13,33	Klemmen /clamps	112,5	81,0	320	1300	5300
ST120.73/04638	230 ±5%	24	16,67	Klemmen /clamps	131,5	105,5	400	1400	6400

Spezifische Kundenwünsche auf Anfrage gerne möglich (z.B. Leistung / Spannung / Rastfuß)

Customized versions optionally available upon request (e. g. power / voltage / click stop device)

Typ/Type

EI150

Steuertransformator
nach VDE 0570 / EN 61558
Vakuumgetränkt
Temperaturklasse ta40°C/B

Offener getränkter Transformator
getrennte Wicklungen
Fusswinkel zur Befestigung
Klemm- und Steckanschluss
6,3 oder 2 x 2,8 mm,
Vorbereitet für Schutzklasse I

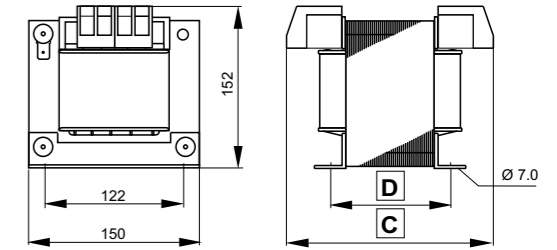

Abmessungen in mm - Dimensions in mm

Nennleistung/Nominal power

500-630 VA

Control transformer
according to VDE 0570 / EN 61558
Vacuum impregnated
Temperature class ta40°C/B

open type, impregnated transformer
separate windings
base angles for fixing
terminals for clamp or plug-in connection
6,3 or 2 x 2,8 mm,
prepared for safety class I



Bestell Nr.	Primär [V]	Sekundär [V]	Strom [A]	Ausführung	Einbaumaße [mm]		Leistung [VA]	Cul - Gewicht [g]	ges. Gewicht [g]
Order No.	Primary	Secondary	Current	version	C	I D	power	Cul-weight	Total-weight

ST150.49/05502	230 ±5%	24	20,83	Klemmen /clamps	137	90	500	1700	7900
ST150.66/05503	230 ±5%	24	26,25	Klemmen /clamps	154	106	630	1800	9900

Spezifische Kundenwünsche auf Anfrage gerne möglich (z.B. Leistung / Spannung / Rastfuß)

Customized versions optionally available upon request (e. g. power / voltage / click stop device)

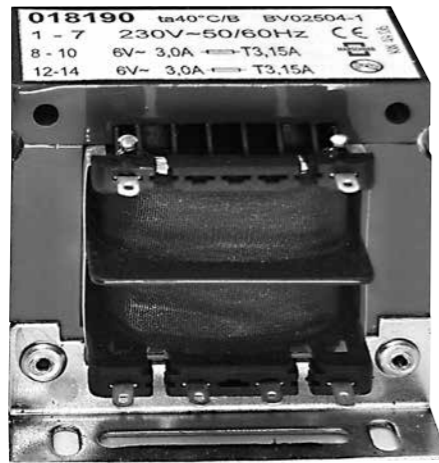

Eigenschaften unserer Netz-Transformatoren:

Netz-Transformatoren sind Transformatoren mit galvanisch getrennten Wicklungen zur Speisung von elektrischen Steuer- und Meldestromkreisen. Je nach Anforderung werden sie mit Basisisolation oder verstärkter Isolierung eingesetzt. Sie finden ihren Einsatz im Steuerungsbau, in Stromversorgungsgeräten und vor allem in Schaltungen, die eine Netztrennung erfordern. Aufgrund der Fußwinkelbefestigung und dem Anschluss von Lötösen sind sie optimal für den Einbau in der Steuerungstechnik geeignet.

Vorteile:

- Betriebsspannung für Steuer- und Hilfsstromkreise an den weltweit verschiedenen Netzspannungen wird jederzeit funktionssicher gewährleistet
- höhere Funktionssicherheit von elektrischen Anlagen
- kompakte Bauweise mit einem Leistungsbereich bis 150 VA
- exakte Kennzeichnung der Anschlüsse, um Verwechslungen beim Anschluss zu vermeiden
- Befestigung mit Fußwinkel oder Rastfuß für Hutschienen
- geerdeter oder ungeerdeter Betrieb wählbar
- Lackgetränkte Wicklungen
- einfache Spannungs- und Isolationsprüfung
- Aufbau gemäss VDE 0570 Teil 2-4 (EN 61558-2-4)

Features of our power-transformers:

Power-transformers are transformers with galvanically separated windings for the feed of electric control and indicating circuits. Depending on the individual requirements, they are used with basic insulation or reinforced insulation. They are applied in control system construction, in power supply devices and mainly in circuits, which require disconnection from power supply. Since they are mounted with base angles and equipped with solder lugs, they are optimal for use in control engineering.

Advantages:

- operating voltage for control and auxiliary circuits at worldwide varying power supply voltages is always guaranteed with functional safety
- higher functional safety of electrical systems
- compact design with power range up to 150 VA
- exact marking of pinning to avoid confusion of pinning
- fixing with base angle or click-stop device for cap rails
- selection between grounded or ungrounded operation
- impregnated windings
- easy voltage and insulation test
- design according to VDE 0570 part 2-4 (EN 61558-2-4)

Aufgrund der umfangreichen Variationsmöglichkeiten können wir in diesem Katalog nur einen Teilbereich abdecken. Wir sind spezialisiert auf kundenspezifische Lösungen und freuen uns daher auf Ihre Anfrage.

Due to the wide range of optionally available variants, this catalog can cover only a part of our total product range. We are specialized on customized solutions and look forward to your inquiry.

Typ/Type

EI54

Netztransformator nach VDE 0570 / EN 61558
Vakuumgetränkt
Temperaturklasse ta40°C/B

Offener getränkter Transformator
getrennte Wicklungen
Fußwinkel zur Befestigung
geeignet zum Einbau bis IP20
Vorbereitet für Schutzklasse I

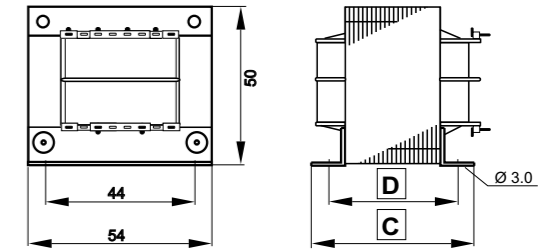

Abmessungen in mm - Dimensions in mm

Nennleistung/Nominal power

12 VA

Power transformer according to VDE 0570 / EN 61558
Vacuum impregnated
Temperature class ta40°C/B

open type, impregnated transformer
separate windings
base angles for fixing
appropriate for installation up to IP20
prepared for safety class I

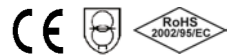

Bestell Nr.	Primär [V]	Sekundär [V]	Strom [A]	Ausführung	Einbaumaße [mm]	Leistung [VA]	Cul - Gewicht [g]	ges. Gewicht [g]
Order No.	Primary	Secondary	Current	version	dimensions	power	Cul-weight	Total-weight
NT54.18/17008	230	2x12	1	Lötösen / solder lugs	44,8 33,6	12	80	370

Typ/Type

EI60

Netztransformator nach VDE 0570 / EN 61558
Vakuumgetränkt
Temperaturklasse ta40°C/B

Offener getränkter Transformator
getrennte Wicklungen
Fußwinkel zur Befestigung
geeignet zum Einbau bis IP20
Vorbereitet für Schutzklasse I

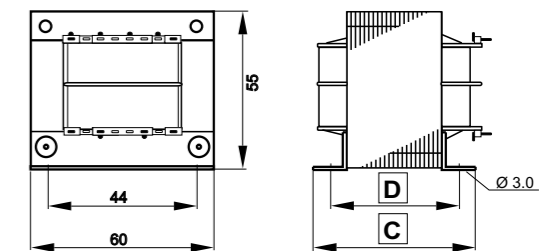

Abmessungen in mm - Dimensions in mm

Nennleistung/Nominal power

24-36 VA

Power transformer according to VDE 0570 / EN 61558
Vacuum impregnated
Temperature class ta40°C/B

open type, impregnated transformer
separate windings
base angles for fixing
appropriate for installation up to IP20
prepared for safety class I



Bestell Nr.	Primär [V]	Sekundär [V]	Strom [A]	Ausführung	Einbaumaße [mm]	Leistung [VA]	Cul - Gewicht [g]	ges. Gewicht [g]
Order No.	Primary	Secondary	Current	version	dimensions	power	Cul-weight	Total-weight
NT60.21/02495	230	2x12	2	Lötösen / solder lugs	47,0 37,2	24	110	490
NT60.30/02499	230	2x12	3	Lötösen / solder lugs	56,5 46,7	36	130	690

Spezifische Kundenwünsche auf Anfrage gerne möglich (z.B. Leistung / Spannung / Rastfuß)
Customized versions optionally available upon request (e. g. power / voltage / click stop device)

Typ/Type

EI66

Netztransformator
nach VDE 0570 / EN 61558
Vakuumgetränkt
Temperaturklasse ta40°C/B

Offener getränkter Transformator
getrennte Wicklungen
Fusswinkel zur Befestigung
geeignet zum Einbau bis IP20
Vorbereitet für Schutzklasse I

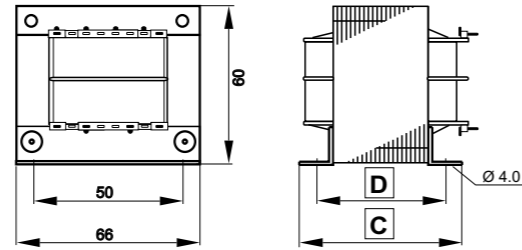

Abmessungen in mm - Dimensions in mm

Nennleistung/Nominal power

48 VA

Power transformer
according to VDE 0570 / EN 61558
Vacuum impregnated
Temperature class ta40°C/B

open type, impregnated transformer
separate windings
base angles for fixing
appropriate for installation up to IP20
prepared for safety class I



Bestell Nr.	Primär [V]	Sekundär [V]	Strom [A]	Ausführung	Einbaumaße [mm]			Leistung [VA]	Cul - Gewicht [g]	ges. Gewicht [g]
Order No.	Primary	Secondary	Current	version	C	I	D	power	Cul-weight	Total-weight
NT66.30/19094	230	2x12	2	Lötösen / solder lugs	60,0	48,8		48	170	850

Typ/Type

EI78

Netztransformator
nach VDE 0570 / EN 61558
Vakuumgetränkt
Temperaturklasse ta40°C/B

Offener getränkter Transformator
getrennte Wicklungen
Fusswinkel zur Befestigung
geeignet zum Einbau bis IP20
Vorbereitet für Schutzklasse I

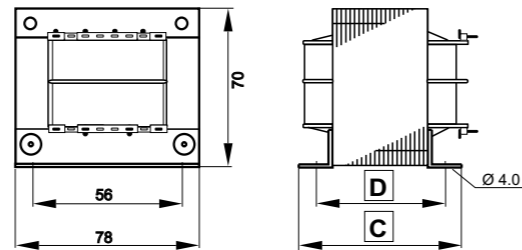

Abmessungen in mm - Dimensions in mm

Nennleistung/Nominal power

72-108 VA

Power transformer
according to VDE 0570 / EN 61558
Vacuum impregnated
Temperature class ta40°C/B

open type, impregnated transformer
separate windings
base angles for fixing
appropriate for installation up to IP20
prepared for safety class I



Bestell Nr.	Primär [V]	Sekundär [V]	Strom [A]	Ausführung	Einbaumaße [mm]			Leistung [VA]	Cul - Gewicht [g]	ges. Gewicht [g]
Order No.	Primary	Secondary	Current	version	C	I	D	power	Cul-weight	Total-weight
NT78.27/02965	230	2x12	3,0	Lötösen / solder lugs	57,5	44,5		72	250	1100
NT78.40/02968	230	2x12	4,5	Lötösen / solder lugs	70,5	57,3		108	290	1580

Spezifische Kundenwünsche auf Anfrage gerne möglich (z.B. Leistung / Spannung / Rastfuß)

Customized versions optionally available upon request (e. g. power / voltage / click stop device)

Typ/Type

EI96

Netztransformator
nach VDE 0570 / EN 61558
Vakuumgetränkt
Temperaturklasse ta40°C/B

Offener getränkter Transformator
getrennte Wicklungen
Fusswinkel zur Befestigung
geeignet zum Einbau bis IP20
Vorbereitet für Schutzklasse I

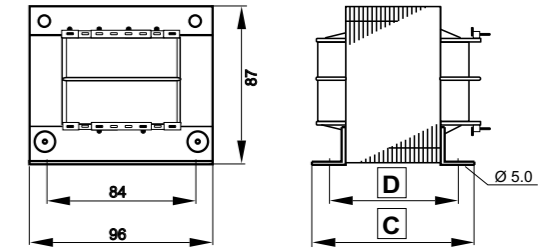

Abmessungen in mm - Dimensions in mm

Nennleistung/Nominal power

150 VA

Power transformer
according to VDE 0570 / EN 61558
Vacuum impregnated
Temperature class ta40°C/B

open type, impregnated transformer
separate windings
base angles for fixing
appropriate for installation up to IP20
prepared for safety class I



Bestell Nr.	Primär [V]	Sekundär [V]	Strom [A]	Ausführung	Einbaumaße [mm]			Leistung [VA]	Cul - Gewicht [g]	ges. Gewicht [g]
Order No.	Primary	Secondary	Current	version	C	I	D	power	Cul-weight	Total-weight
NT96.35/05345	230	2x12	6,25	Lötösen / solder lugs	75,7	59,3		150	480	2210

Spezifische Kundenwünsche auf Anfrage gerne möglich (z.B. Leistung / Spannung / Rastfuß)

Customized versions optionally available upon request (e. g. power / voltage / click stop device)

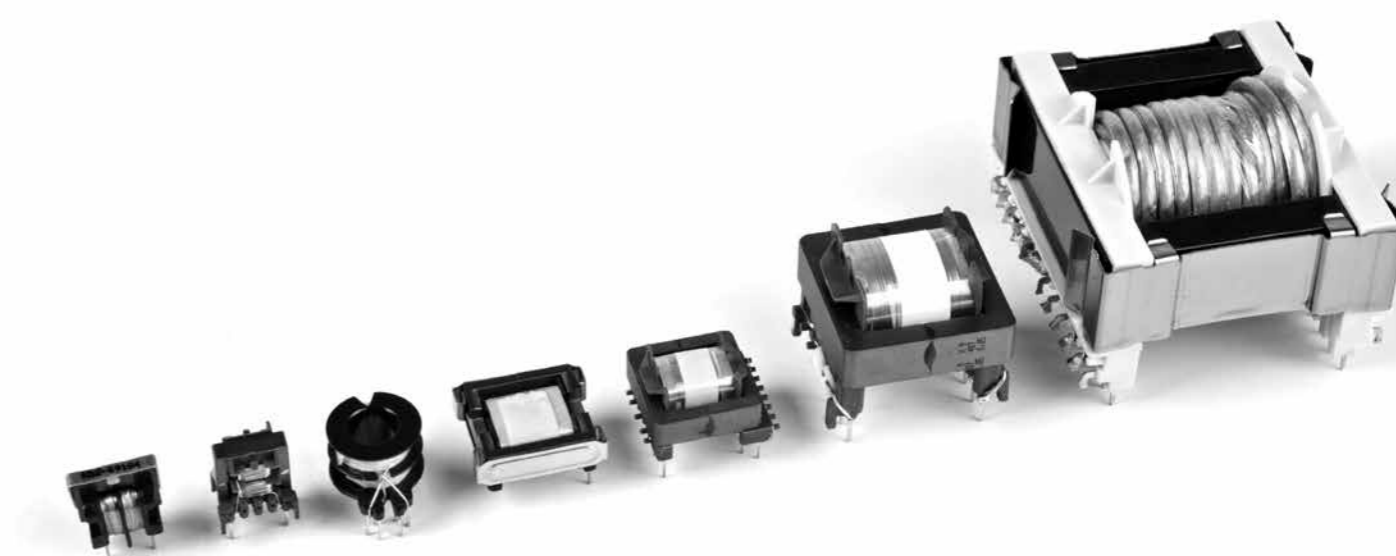
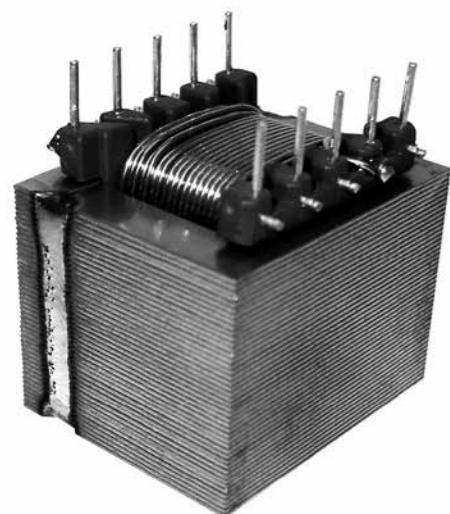

Eigenschaften unserer Netzdrosseln:

Netzdrosseln sind Spulen, die zur Dämpfung, Funkentstörung, Strombegrenzung und zur Unterdrückung unerwünschter Frequenzen oder zur Energiespeicherung in Schaltnetzteilen eingesetzt werden. Netzdrosseln liegen direkt im Wechselstromkreis. So kommen z. B.

- Kompensationsdrosseln
- Strombegrenzungsdrosseln
- Filterdrosseln
- Glättungsdrosseln
- PFC-Drosseln

zum Einsatz.

Sämtliche Varianten werden von uns kundenspezifisch hergestellt. Drosseln können sowohl als Luftdrossel als auch mit Eisenkern hergestellt werden.

Wir bieten Anschlussvarianten, wie z. B.

- Anschlussklemmen
- Printanschluss
- Kabel oder Litze
- freie Drahtenden

Durch unsere langjährige Erfahrung im Bereich der Wickeltechnik und der Herstellung von Spritzgusswerkzeugen sind zahlreiche Sonderausführungen möglich.

Features of our line chokes:

Line chokes are coils, which are used for damping, radio shielding, current limiting and for the suppression of undesired frequencies or for energy storage in switch-mode power supplies. Line chokes are located directly in the alternating current circuit. The following versions are applied:

- compensation chokes
- current limiting chokes
- filter chokes
- smoothing chokes
- PFC chokes

We manufacture all variants in compliance with customer specifications. Chokes can be manufactured either as air-cored chokes or also with iron core.

We offer different connection variants, such as

- terminal clamps
- print connection
- cable or strand
- free wire ends

Our experience from many years in the field of coiling technology and in the manufacturing of injection molds enable us to manufacture numerous special versions.

Sämtliche Baugrößen können wir nach Kundenwunsch anpassen:

- abweichende Ströme, Induktivitätswerte und Bauformen
- offene, getränkte und vergossene Versionen möglich
- unterschiedliche Anschlüsse (Flachstecker, Lötösen, Reihenklemmen, konfektionierte Anschlüsse)
- unterschiedliche Befestigungsmöglichkeiten (Fußwinkel und Hutschienen)

Customization of all sizes is possible:

- differing currents, inductance values and designs
- open, impregnated and potted versions possible
- different connections (blade terminals, solder lugs, terminal strips, ready-for-use terminals)
- different mounting versions (base angles and cap rails)

Einsatzbereiche unserer Ferrit Bauteile:

Ferrit-Transformatoren und -Wandler kommen in hohen Frequenzbereichen zum Einsatz. Hauptanwendungen sind Schaltnetzteile sowie die Bereiche Telekommunikation, Solar- und Beleuchtungstechnik. Hierfür fertigen wir sämtliche Bauteile in Form von Übertragern, Drosseln, Konvertern, Flyback-Übertragern und Sperrwandlern. Folgende Kernvarianten mit Pins (THT) bzw. SMD können eingesetzt werden:

- EF-Kern
- EFD-Kern
- ETD-Kern
- EP-Kern
- RM-Kern
- U-Kern
- Schalenkern

Die Bauteile werden gemäß der gültigen Vorschriften hergestellt. Die eingesetzten Materialien sind hochwertig verarbeitet und bieten dadurch eine hohe Zuverlässigkeit.

Applications of our ferrite components:

Ferrite transformers and transducers are applied in high frequency ranges. Key applications are switch-mode power supplies as well as in the fields of telecommunication, solar and illuminating engineering. For these purposes, we manufacture all components such as transformers, chokes, converters, flyback transformers and blocking converters. The following key variants with pins (THT) or SMD can be applied:

- EF core
- EFD core
- ETD core
- EP core
- RM core
- U core
- pot core

The components are manufactured in compliance with the applicable provisions. The materials used have a high processing quality and thus provide high reliability.

Aufgrund der umfangreichen Variationsmöglichkeiten können wir in diesem Katalog nur einen Teilbereich abdecken. Wir sind spezialisiert auf kundenspezifische Lösungen und freuen uns daher auf Ihre Anfrage.

Due to the wide range of optionally available variants, this catalog can cover only a part of our total product range. We are specialized on customized solutions and look forward to your inquiry.

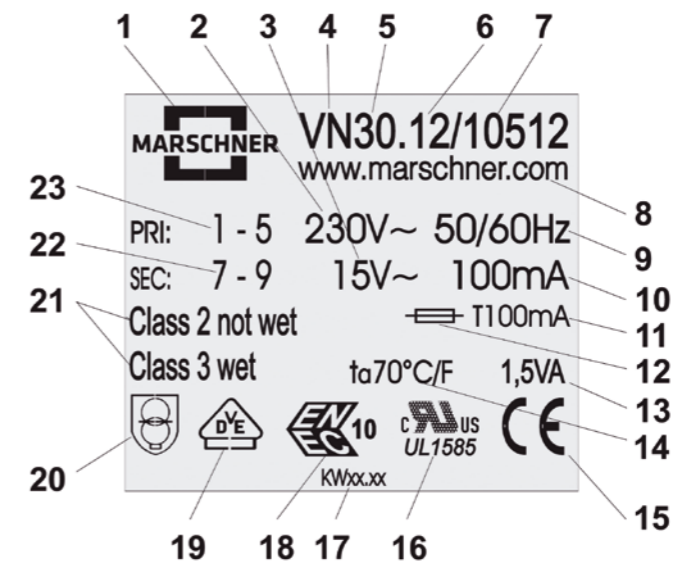

Eigenschaften unserer Spulen:

Features of our coils:

Spulen sind Wickelgüter, die Magnetfelder erzeugen oder detektieren können. Sie werden zur Signalverarbeitung, zur Stör- unterdrückung, zur Glättung oder als Energiespeicher genutzt. Unsere Spulen kommen in unterschiedlichen Anwendungen in der Automobilindustrie oder Solartechnik zum Einsatz.

So bieten wir:

- Magnetspulen
- Ladespulen
- Sensorspulen
- Antennenspulen für Transponder
- Luftspulen auf Spulenträgern

Sämtliche Spulen sind auf die speziellen Anwendungen abgestimmt.

Die optimalen Materialien werden ausgewählt und bei qualifizierten Lieferanten eingekauft und anschließend in gewohnt hoher Qualität verarbeitet.

Durch ein kompetentes Team, in dem Entwicklung und Qualitätssicherung zusammenarbeiten, ist eine flexible und kurzfristige Herstellung von Sonderteilen möglich.

Durch unsere langjährige Erfahrung im Bereich der Wickeltechnik können wir schnell und flexibel Sonderausführungen umsetzen. Durch unser Fertigungskonzept ist es möglich, Klein- und Großserien wirtschaftlich herzustellen.

Coils are wound parts, which can produce or detect magnetic fields. They are used for the suppression of interferences, for smoothing or for energy storage. Our coils are integrated in various applications in the automotive industry or in solar engineering.

We offer:

- magnetic coils
- charging coils
- sensor coils
- antenna coils for transponders
- air-core coils on coil carriers

All coils are adapted to the special applications.

We select the optimum materials and purchase them from qualified suppliers, and then we process them in the high quality you are accustomed to.

A competent team, in which development, quality assurance and toolmakers cooperate, enables us to offer flexible and just-in-time manufacturing of special parts.

Our experience from many years in the field of winding technology and the manufacturing of injection molds, we are able to respond to special demands quickly and flexibly. Our manufacturing concept allows for the cost-effective manufacturing of small and large series.

Aufgrund der umfangreichen Variationsmöglichkeiten können wir in diesem Katalog nur einen Teilbereich abdecken. Wir sind spezialisiert auf kundenspezifische Lösungen und freuen uns daher auf Ihre Anfrage.

Due to the wide range of optionally available variants, this catalog can cover only a part of our total product range. We are specialized on customized solutions and look forward to your inquiry.

- | | |
|--|--|
| <p>1 MARSCHNER-Logo
MARSCHNER logo</p> <p>2 PRI-Spannung (z. B. 230 V~)
PRI voltage (e. g. 230 V~)</p> <p>3 SEC-Spannung (z. B. 15 V~)
SEC voltage (e. g. 15 V~)</p> <p>4 Bauart: z. B. VN > V = vergossen, N = niedrige Bauhöhe
Design: e. g. VN > V = potted, N = low height</p> <p>5 Jochmaß: Größe des Kernblechs
Yoke dimension: Size of the core plate</p> <p>6 Schichthöhe des Blechs
Layer height of the plate</p> <p>7 5 stellige Zahlenkombination = interne Bau-Vorschrift (BV)
5-digit figure combination = internal manufacturing specification (BV)</p> <p>8 Internetseite MARSCHNER
Internet page MARSCHNER</p> <p>9 Frequenzbereich
Frequency range</p> <p>10 SEC-Stromangabe
Inscription of SEC current</p> <p>11 Trägesicherung: Vorgabe zur Absicherung durch Kunden
Delay-action fuse: instruction for fuse protection by customer</p> <p>12 Feinsicherung
Micro-fuse</p> <p>13 max. Ausgangsleistung (in VA)
max. power output (in VA)</p> | <p>14 Bemessungstemperatur / Temperaturklasse
z. B. ta70°C/F
70°C = Umgebungstemperatur
F = 155°C max. erreichbare Temperatur
Design temperature / temperature class
e. g. ta70°C/F
70°C = ambient temperature
F = 155°C max. temperature</p> <p>15 CE-konforme Fertigung
CE-conforming manufacturing</p> <p>16 Prüfzeichen für Canada/USA 1585 Klasse II
Approval for Canada/USA 1585 class II</p> <p>17 Fertigungsdatum KW = Kalenderwoche und Jahr
Manufacturing date CW = calendar week and year</p> <p>18 ENEC 10-Prüfzeichen
ENEC 10 approval</p> <p>19 VDE-Prüfzeichen
VDE approval</p> <p>20 Sicherheitstransformator
Safety transformer</p> <p>21 UL Klasse 2 Transformator
UL class 2 transformer</p> <p>22 Stiftbelegung Ausgangsspannung (SEC)
PIN configuration output voltage (SEC)</p> <p>23 Stiftbelegung Eingangsspannung (PRI)
PIN configuration input voltage (PRI)</p> |
|--|--|

Tampondruckverfahren

Pad printing process

Der Tampondruck ist ein indirektes Tiefdruckverfahren. In eine ebene Platte (ein Klischee) werden Vertiefungen eingeztzt. Diese werden mit Farbe gefüllt. Durch das Verdunsten der Lösemittel in der Farbe wird die Oberfläche klebrig und kann von einem elastischen Silikonkautschuk-Stempel aufgenommen und auf die Kunststoffhaube des Transformators übertragen werden. Dieser Stempel wird Tampon genannt und hat dem Druckverfahren den Namen gegeben.

Der Silikonkautschuk lässt sich leicht verformen und ist farbabweisend. Dadurch wird eine hervorragende Farbübertragung gewährleistet.

Der Tampondruck ist für den industriellen Einsatz das wichtigste Verfahren zum Bedrucken von Kunststoffkörpern. Daher wenden auch wir bei MARSCHNER dieses bewährte kratz- und wischfeste Druckverfahren an.

Bei kundenspezifischen Ausführungen können wir Ihr Firmenlogo sogar in unterschiedlichen Farben aufdrucken. Somit heben Sie sich im Markt ab und bauen Ihre exklusive Position weiter aus. Gerne stehen wir Ihnen bei der Gestaltung des Klischees zur Verfügung!

The pad printing process is an indirect gravure printing process, in which recesses are etched into an even plate (a printing plate). These recesses are filled with ink. The vaporization of the solvents in the ink makes the surface adhesive and it can therefore be taken by an elastic silicone rubber plunger and be transferred to the plastic case of the transformer. This plunger is called pad and has given this printing process its name.

The silicone rubber can be easily formed and is ink repellent. This guarantees an excellent ink transfer.

The pad printing process is the most important process for the printing of plastic parts in industrial application. For this reason, MARSCHNER also applies this well-proven scratch-proof and smudge-proof printing process.

In customized versions, we can even print your company logo in different colors. It can therefore be clearly distinguished from the logos of your competitors in the market, and so you can strengthen your exclusive position. We will gladly provide assistance to you in the design of the printing plate!



Tampondruckmaschine
Pad printing machine

Normungsorganisationen

Standards organizations

VDE

VDE (Verband der Elektrotechnik Elektronik Informatonstechnik e.V.)

Der gemeinnützige Verband der Elektrotechnik (VDE) wurde 1893 gegründet und ist ein technisch-wissenschaftlicher Verein. Das VDE Prüf- und Zertifizierungsinstitut mit Sitz in Offenbach gehört zu den unabhängigen Prüforganismen für elektrotechnische Produkte. Weltweit tragen mehr als 200.000 Produkte das Siegel des VDE. Mehr als 35.000 Mitglieder und 1.000 Mitarbeiter gehören dem Verein an. Schwerpunkt sind die Sicherheit in der Elektrotechnik, die Erarbeitung anerkannter Regeln als nationale und internationale Normen sowie die Prüfung und Zertifizierung von Geräten.

VDE (acronym for the German association of electrical engineering, electronics and information technology) The non-profit association of electric engineering was founded in 1893 and is a technical and scientific association. The VDE testing and certification institute in Offenbach is one of the independent organizations for the testing of electrotechnical products. Worldwide, more than 200,000 products bear the VDE seal. More than 35,000 members and 1,000 employees are organized in this association. Its key activities comprise safety in electrical engineering, the development of acknowledged rules as national and international standards, as well as the testing and certification of devices.



UL (Underwriters Laboratories, Inc.)

Die 1894 gegründete unabhängige Organisation Underwriters Laboratories (UL) untersucht und zertifiziert Produkte, Komponenten und Materialien hinsichtlich ihrer Sicherheit. UL hat darüber hinaus mehr als 1.300 Sicherheitsnormen entwickelt. Eine typische Norm für Elektroartikel umfasst nicht nur die Anforderungen an die elektrische Sicherheit, sondern auch ein breites Spektrum im Hinblick auf Entflammbarkeit und mechanischen Gefahrenquellen. Der Hauptsitz befindet sich in Northbrook, US-Bundesstaat Illinois. Unangemeldete, regelmäßige Inspektionen werden in den Unternehmen vor Ort von der deutschen Zentrale in Neu-Isenburg bei Frankfurt am Main koordiniert.

UL (Underwriters Laboratories, Inc.) The independent organization Underwriters Laboratories (UL) was founded in 1894 and examines and certifies products, components and materials with regard to safety. Additionally, UL has developed more than 1,300 safety standards. A typical standard for electrical products comprises not only electric safety but also a wide range of issues concerning inflammability and mechanical sources of hazards. Its headquarters is in Northbrook, in the US state of Illinois. Unannounced regular on-site inspections in the companies are coordinated by the German center in Neu-Isenburg near Frankfurt on the Main.



CENELEC (Comité Européen de Normalisation Électrotechnique)

1973 wurde die gemeinnützige Organisation Europäisches Komitee für elektrotechnische Normung (CENELEC) mit heutigem Sitz in Brüssel gegründet und ist heute eine der drei großen Normungsorganisationen im Bereich Elektrotechnik in Europa. Das ENEC-Verfahren regelt den europaweit einheitlichen, von allen Teilnehmerstaaten anerkannten Konformitätsnachweis. Die Einbeziehung von Instituten anderer europäischer Länder soll die nationalen Normungsinstitute der neuen Demokratien in Mittel- und Osteuropa unterstützen und sie enger mit dem europäischen Wirtschaftsraum verbinden.

CENELEC (Comité Européen de Normalisation Électrotechnique) In 1973, the non-profit organization European committee for electrotechnical standardization (CENELEC), whose headquarters is currently located in Brussels, was founded. Nowadays, it is one of Europe's three big standardization organizations in the field of electrical engineering. The ENEC process governs the uniform EU certificate of conformance, which is acknowledged by all member states. The involvement of institutes in other European countries is intended to support the national standardization institutes of the new democratic states in Central and Eastern Europe and link them closer with the European market.



IEC (International Electrotechnical Commission)

Im Jahr 1906 wurde die Internationale Elektrotechnische Kommission (IEC) in London gegründet und hat mittlerweile sein Hauptquartier in Genf. Ein mehrsprachiges internationales Wörterbuch wurde 1938 veröffentlicht, um die elektrotechnischen Begriffe zu vereinheitlichen. Somit gehen wichtige Normen im Bereich der Elektrotechnik und Elektronik auf die Arbeit des IEC zurück.

IEC (International Electrotechnical Commission) In 1906, the IEC was founded in London. Meanwhile, its headquarters is located in Geneva. A multilingual international dictionary was published in 1938 to harmonize the electrotechnical terms. Important standards in the field of electrical engineering are rooted in the work of the IEC.



CSA (Canadian Standards Association)

Die Canadian Standards Association (CSA) ist eine nicht-staatliche technische Prüforganismen, die Normen und Standards setzt sowie Produkte auf ihre Sicherheit überprüft und zertifiziert. Sie wurde im Jahr 1919 in Kanada gegründet und ist mittlerweile weltweit tätig. Das CSA-Prüfzeichen ist insbesondere in den USA und Kanada von großer Bedeutung. Die Gesetzgebung verlangt in Kanada, dass alle in Verkehr gebrachten elektrischen Erzeugnisse die Vorschriften des Canadian Electrical Code erfüllen.

CSA (Canadian Standards Association) The Canadian Standards Association (CSA) is a non-state technical inspection organization, which sets standards and norms and also inspects products for safety and certifies them. It was founded in Canada in 1919 and meanwhile is active all over the world. The CSA approval has high importance especially in the USA and Canada. In Canada, legislation requires that all products marketed in Canada comply with the provisions of the Canadian Electrical Code.

Prüfzeichen Approvals



CE-Kennzeichnung
gesetzliches Konformitätskennzeichen in Europa,
Kennzeichnung belegt die Einhaltung der für das
Produkt gültigen europäischen Richtlinien.

CE marking
symbol of legal conformance in Europe



ENEC-Prüfzeichen
hier: Zertifizierung durch VDE (10)

ENEC approval mark
Here: certified by VDE (10)



VDE-Prüfzeichen
Deutschland, VDE Prüf- und Zertifizierungsinstitut,
Offenbach

VDE approval mark
*Germany, VDE testing and certification institute,
Offenbach*



VDE-Prüfzeichen
Prüfung in Verbindung mit Gerät,
Transformator hat keine Einzelapprobation

VDE approval mark
*certification in connection with device
transformer has no separate approval*



UL-Prüfzeichen
(recognized component),
USA, Underwriters Laboratories, Inc.

UL approval mark
*(recognized component),
USA, Underwriters Laboratories, Inc.*



CSA-Prüfzeichen
Kanada, Canadian Standards Association

CSA approval mark
Canada, Canadian Standards Association



UL-Prüfzeichen
(recognized component),
Kanada und USA, hier:
Zertifizierung durch UL, Underwriters Laboratories, Inc.

UL-certification
*(recognized component),
Canada and USA, here: certification by UL,
Underwriters Laboratories, Inc.*

Zeichen und Symbole Characters and symbols



Sicherheitstransformator, kurzschlussfest
nach VDE 0570 Teil 26/EN 61558-2-6/IEC 61558-2-6
(unbedingt oder bedingt)
■ max. PRI Spannung 1000 V
■ max. SEC Spannung 50 V AC (Effektivwert)
oder 120 V DC geglättet
■ doppelte oder verstärkte Isolierung zwischen
PRI und SEC

Safety transformer, short-circuit proof
*according to VDE 0570 Part 26/EN 61558-2-6/
IEC 61558-2-6*
■ max. PRI voltage 1000 V
■ max. SEC voltage 50 V AC (effective value)
or 120 V DC smoothed
■ doubled or reinforced insulation between PRI and SEC



Sicherheitstransformator, nicht kurzschlussfest
nach VDE 0570 Teil 26/EN 61558-2-6/IEC 61558-2-6
■ max. PRI Spannung 1000 V
■ max. SEC Spannung 50 V AC (Effektivwert)
oder 120 V DC geglättet
■ doppelte oder verstärkte Isolierung zwischen
PRI und SEC

Safety transformer, non short-circuit proof
*according to VDE 0570 Part 26/EN 61558-2-6/
IEC 61558-2-6*
■ max. PRI voltage 1000 V
■ max. SEC voltage 50 V AC (effective value)
or 120 V DC smoothed
■ doubled or reinforced insulation between PRI and SEC



Sicherheitstransformator, Failsafe
nach VDE 0570 Teil 26/EN 61558-2-6/IEC 61558-2-6
■ max. PRI Spannung 1000 V
■ max. SEC Spannung 50 V AC (Effektivwert)
oder 120 V DC geglättet
■ doppelte oder verstärkte Isolierung zwischen
PRI und SEC

Safety transformer, fail-safe
*according to VDE 0570 Part 26/EN 61558-2-6/
IEC 61558-2-6*
■ max. PRI voltage 1000 V
■ max. SEC voltage 50 V AC (effective value)
or 120 V DC smoothed
■ doubled or reinforced insulation between PRI and SEC



Trenntransformator, kurzschlussfest
nach VDE 0570 Teil 24/EN 61558-2-4/IEC 61558-2-4
■ max. PRI Spannung 1000 V
■ max. SEC Spannung 500 V AC (Effektivwert)
oder 708 V DC geglättet
■ doppelte oder verstärkte Isolierung zwischen
PRI und SEC

Isolation transformer, short-circuit proof
*according to VDE 0570 Part 24/EN 61558-2-4/
IEC 61558-2-4*
■ max. PRI voltage 1000 V
■ max. SEC voltage 500 V AC (effective value)
or 708 V DC smoothed
■ doubled or reinforced insulation between PRI and SEC



Trenntransformator, nicht kurzschlussfest
nach VDE 0570 Teil 24/EN 61558-2-4/IEC 61558-2-4
■ max. PRI Spannung 1000 V
■ max. SEC Spannung 500 V AC (Effektivwert)
oder 708 V DC geglättet
■ doppelte oder verstärkte Isolierung zwischen
PRI und SEC

Isolation transformer, non short-circuit proof
*according to VDE 0570 Part 24/EN 61558-2-4/
IEC 61558-2-4*
■ max. PRI voltage 1000 V
■ max. SEC voltage 500 V AC (effective value)
or 708 V DC smoothed
■ doubled or reinforced insulation between PRI and SEC

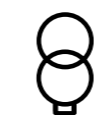

Netztransformator, kurzschlussfest
nach VDE 0570 Teil 21/EN 61558-2-1/IEC 61558-2-1
■ max. PRI Spannung 1000 V
■ max. SEC Spannung 1000 V AC (Effektivwert)
oder 1415 V DC geglättet
■ Basisisolation zwischen PRI und SEC

Power transformer, short-circuit proof
according to VDE 0570 Part 21/EN 61558-2-1/IEC 61558-2-1
■ max. PRI-Voltage 1000 V
■ max. SEC voltage 1000 V AC (effective value)
or 1415 V DC smoothed
■ basic insulation between PRI and SEC



Netztransformator, nicht kurzschlussfest
nach VDE 0570 Teil 21/EN 61558-2-1/IEC 61558-2-1
■ max. PRI Spannung 1000 V
■ max. SEC Spannung 1000 V AC (Effektivwert)
oder 1415 V DC geglättet
■ Basisisolation zwischen PRI und SEC

Power transformer, non short-circuit proof
according to VDE 0570 Part 21/EN 61558-2-1/IEC 61558-2-1
■ max. PRI voltage 1000 V
■ max. SEC voltage 1000 V AC (effective value)
or 1415 V DC smoothed
■ basic insulation between PRI and SEC



















Steuertransformator, nicht kurzschlussfest
nach VDE 0570 Teil 22/EN 61558-2-2/IEC 61558-2-2
■ max. PRI Spannung 1000 V
■ max. SEC Spannung 1000 V AC (Effektivwert)
oder 1415 V DC geglättet
■ Basisisolation zwischen PRI und SEC

Control transformer
according to VDE 0570 Part 22/EN 61558-2-2/IEC 61558-2-2
■ max. PRI voltage 1000 V
■ max. SEC voltage 1000 V AC (effective value)
or 1415 V DC smoothed
■ basic insulation between PRI and SEC

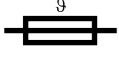

Spartransformator
nach VDE 0570 Teil 13/EN 61558-2-13/IEC 61558-2-13
■ max. PRI Spannung 1000 V
■ max. SEC Spannung 1000 V AC (Effektivwert)
oder 1415 V DC geglättet
■ ohne Isolierung zwischen PRI und SEC

Auto-transformer
*according to VDE 0570 Part 13/EN 61558-2-13/
IEC 61558-2-13*
■ max. PRI voltage 1000 V
■ max. SEC voltage 1000 V AC (effective value)
or 1415 V DC smoothed
■ basic insulation between PRI and SEC

PRI	Eingangsspannung Angabe der nominalen Eingangsspannung z.B. PRI 230V	Input quotation of nominal input voltage for example PRI 230 V		Schutzisolierung Schutzklasse III	<i>Protective insulation</i> Protection class III
SEC	Ausgangsspannung Angabe der nominalen Ausgangsspannung z. B. SEC 12V	Output quotation of nominal output voltage for example SEC 12 V		Geräte, die mit Schutzkleinspannung betrieben werden (SELV)	<i>Devices which are operated with safety extra low voltage (SELV)</i>
ta 70°C	Bemessungs - Umgebungstemperatur z. B. 70°C	Rated ambient temperature for example 70°C		Schutzleiter, Erde	<i>Protective conductor, ground</i>
/B	Isolierstoffklasse z. B. B, beschreibt die thermische Beständigkeit der verwendeten Isolierstoffe. Bei Transformatoren zählt immer das Material mit dem niedrigsten Wert im System. A=110°C, E=120°C, B=130°C, F=155°C, H=180°C	Insulation class for example B, describes the thermal stability of insulation materials used. For transformer the material with the lowest value in the system. A=110°C, E=120°C, B=130°C, F=155°C, H=180°C		Anschluss für Kern	<i>Core terminal</i>
	Wechselstrom auch AC oder ac genannt hier Einphasen-Wechselstrom	Alternating current also referred to as AC or ac for example one phase		Einsatz im Haus bzw. in trockenen Räumen geeignet	<i>Symbol for indoor use, for dry rooms</i>
	Gleichstrom auch DC oder dc genannt	Direct current also referred to as DC or dc		Zeichen nach VDE 0710 Teil 14 Gerät ist geeignet zur Verwendung bei Einrichtungsgegenständen (Holz, Möbel...)	<i>Symbol according to VDE 0710 part 14 device is suitable for use with fitments (furniture, wood...)</i>
	Sicherung bei nicht kurzschlussfesten Transformatoren mit Angabe der zu verwendenden Sicherung, hier 1 A träge	Fuse for non-short circuit proof transformer with quotation of the fuse to be used, here 1 A slow-blow		Bildzeichen für Schutz gegen Eindringen von Wasser Hier: IPX3 Schutz gegen Sprühwasser, bis 60° gegenüber normaler Betriebslage	<i>Graphic symbol for protection against intrusion of water</i> Here: IPX3 protection against spray water, up to 60° in comparison with normal operating conditions
	Temperatursicherung Schalttemperatur wird ebenfalls angegeben	Thermal fuse cut off temperature is specified		Bildzeichen für Schutz gegen Eindringen von Staub Hier: IP6X Schutz gegen Eindringen von Staub (staubdicht), vollständiger Berührungsschutz	<i>Graphic symbol for protection against intrusion of dust</i> Here: IP6X protection against the intrusion of dust (dustproof), total protection against touch
	Temperaturschalter selbstständig zurückstellend, z. B. Bimetallschalter	Thermal switch automatically resetting, for example bimetal switch		Zeichen für Funkentstörung	<i>Graphic symbol for radio shielding</i>
	Temperaturschalter nicht selbstständig zurückstellend, z. B. Bimetallschalter mit Heizwiderstand	Thermal switch non automatically resetting, for example bimetal switch with heating resistor		Zeichen für RoHS Konformität gemäß der "Richtlinie zur Beschränkung der Verwendung bestimmter gefährlicher Stoffe in Elektro- oder Elektronikgeräten"	<i>Graphic symbol for RoHS conformance according to the directive "Restriction of the use of certain hazardous substances in electrical and electronic equipment"</i>
	Kaltleiter (PTC) Schutzklasse II	PTC-resistor protection class II			

Bestückungsplan Transformatoren

Pinout of transformers

Die Zeichnungen geben Aufschluss über die Bestückungsmöglichkeiten der Transformatoren mit Lötstiften in vergossener und offener Ausführung bzw. Bauart. Wir empfehlen, die Stiftbelegung des Transformators jeweils so zu wählen, dass ein falscher bzw. verdrehter Einbau in die Leiterplatte ausgeschlossen werden kann, z. B. PRI 1-5 / SEC 7-9.

The drawings provide information about the options for equipping the transformer with solder pints in potted and unpotted design or version. We recommend to select a pin configuration of the transformer that excludes incorrect or distorted mounting into the PCB, e.g. PRI 1-5 / SEC 7-9

EE- und EI-Transformatoren/ EE- and EI-transformers

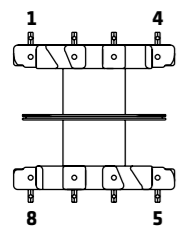

Type EE20
4 Stifte pro Stiftreihe
Stiftabstand 5 mm

Type EE20
4 pins per pin row
distance 5 mm

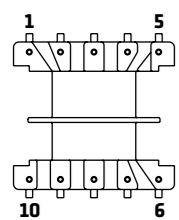

Type EI30
5 Stifte pro Stiftreihe
Stiftabstand 5 mm

Type EI30
5 pins per pin row
distance 5 mm

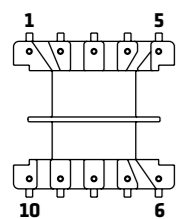

Type EI38
5 Stifte pro Stiftreihe
Stiftabstand 5 mm

Type EI38
5 pins per pin row
distance 5 mm

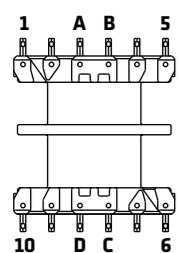

Type EI42
6 Stifte pro Stiftreihe
Stiftabstand 5 mm

Type EI42
6 pins per pin row
distance 5 mm

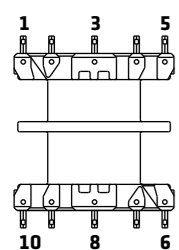

Type EI42
5 Stifte pro Stiftreihe
Stiftabstand 5-7,5-7,5-5 mm

Type EI42
5 pins per pin row
distance 5-7.5-7.5-5 mm

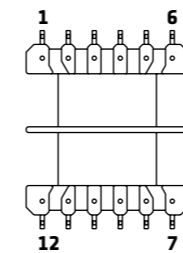

Type EI48
6 Stifte pro Stiftreihe
Stiftabstand 5 mm

Type EI48
6 pins per pin row
distance 5 mm

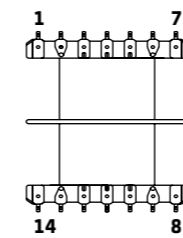

Type EI54
7 Stifte pro Stiftreihe
Stiftabstand 5 mm
oder 5 Stifte pro Stiftreihe
Stiftabstand 7,5-10-10-7,5mm

Type EI54
7 pins per pin row
distance 5 mm or
5 pins per pin row
distance 7.5-10-10-7.5 mm

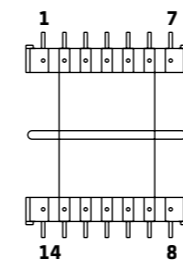

Type EI60
7 Stifte pro Stiftreihe
Stiftabstand 5 mm

Type EI60
7 pins per pin row
distance 5 mm

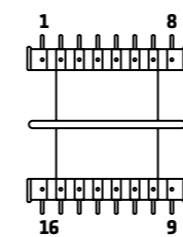

Type EI66
8 Stifte pro Stiftreihe
Stiftabstand 5 mm

Type EI66
8 pins per pin row
distance 5 mm

UI-Transformatoren/UI-transformers

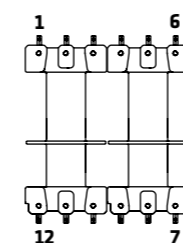

Type UI21
6 Stifte pro Stiftreihe
Stiftabstand 2x5-3,5-2x5 mm

Type UI21
6 pins per pin row
distance 2x5-3.5-2x5 mm

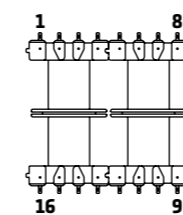

Type UI30
8 Stifte pro Stiftreihe
Stiftabstand 5 mm

Type UI30
8 pins per pin row
distance 7x5 mm

Anschlussschema UI Transformatoren

Connection diagrams UI transformers

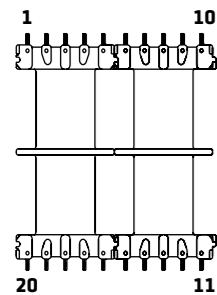

Typ UI39
10 Stifte pro Stiftreihe
Stiftabstand 4x5-6-4x5 mm

Type UI39
10 pins per pin row
distance 4x5-6-4x5 mm

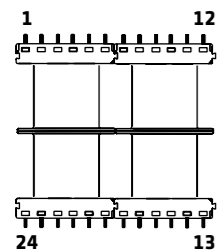

Typ UI48
12 Stifte pro Stiftreihe
Stiftabstand 5x5-7-5x5 mm

Type UI48
12 pins per pin row
distance 5x5-7-5x5 mm

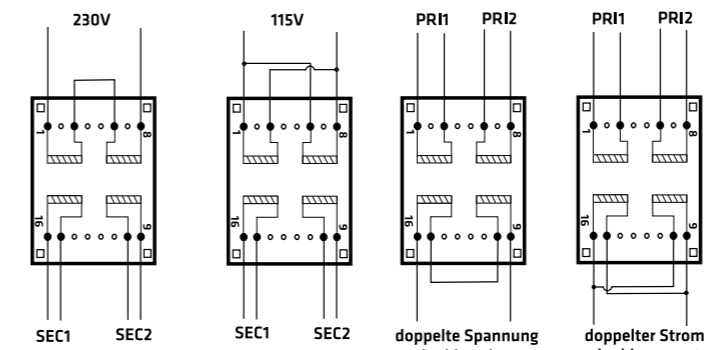

Typ FLG30.xx/60xxx
Anschlussvarianten für unsere
Flachtransformatoren

Type FLG30.xx/60xxx
connection variants of our low profile
transformers

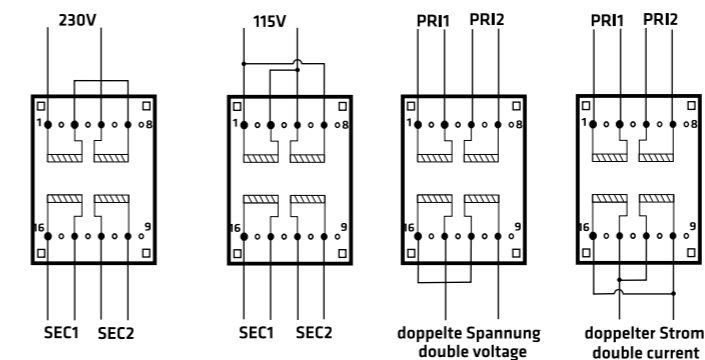

Typ FLG30.xx/61xxx
Alternativ bieten wir das komplette
Flachtransformatoren-Programm
in einer zweiten Variante mit den
aufgeführten Anschlussvarianten.

Type FLG30.xx/61xxx
As an alternative, we offer the complete
low profile range in a second variant with
the connection variants presented below.

Zählrichtung/counting direction

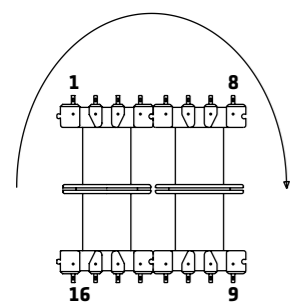

Für alle Transformatoren
gilt die Zählrichtung
"Im Uhrzeigersinn"

*For all transformers
counting direction
"clockwise"*

Mögliche Anschlüsse/possible connections

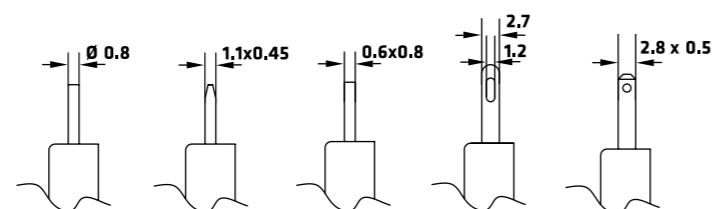

Weitere Anschlussmöglichkeiten auf Anfrage gerne möglich.
We gladly offer further connection options upon request.

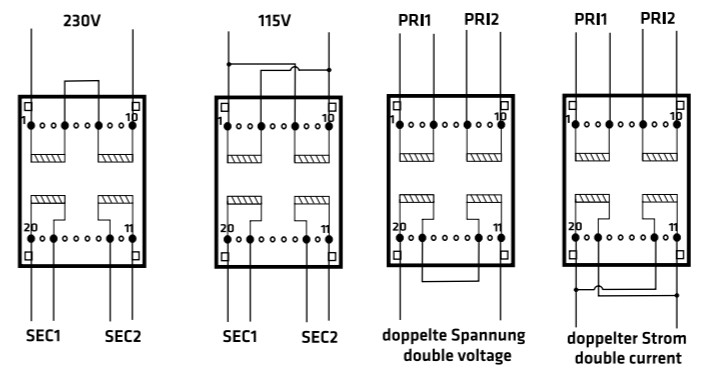

Typ FLG39.xx/60xxx
Anschlussvarianten für unsere
Flachtransformatoren

Type FLG39.xx/60xxx
connection variants of our low profile
transformers

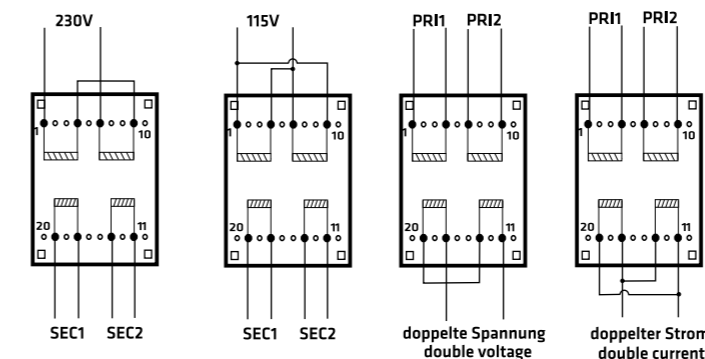

Typ FLG39.xx/61xxx
Alternativ bieten wir das komplette
Flachtransformatoren-Programm
in einer zweiten Variante mit den
aufgeführten Anschlussvarianten.

Type FLG39.xx/61xxx
As an alternative, we offer the complete
low profile range in a second variant with
the connection variants presented below.

Mögliche Gehäuseformen

Possible types of housing

Unterschiedliche Geräte erfordern oftmals unterschiedliche Gehäuseformen oder Befestigungsmöglichkeiten. Hierzu können wir die unten aufgeführten Varianten anbieten. Darüber hinaus sind wir durch unseren eigenen Werkzeug- und Formenbau sowie aufgrund unserer eigenen Kunststoffspritzerei in der Lage, spezifische Gehäuse herzustellen.

Different devices often require different housing shapes or mounting options. We can cover these demands by offering the variants presented below. Additionally, our in-house tool making department and plastic injection molding shop enable us to manufacture specific housing.

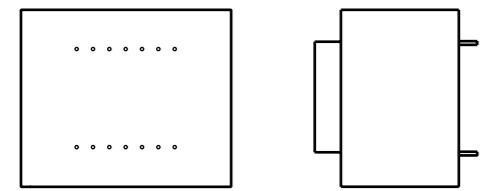

Typ „0“
ohne Befestigung

Type “0”
without fixing

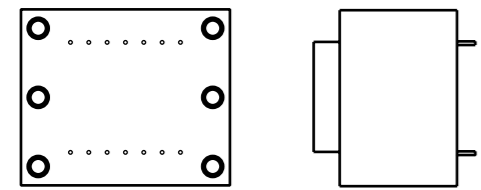

Typ „BO“
mit innenliegender Befestigungsleiste

Type “BO”
with fixing rail inside

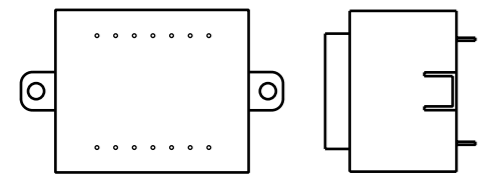

Typ „K“
mit je einer Befestigung an der kurzen Seite

Type “K”
one mounting bracket on each short side

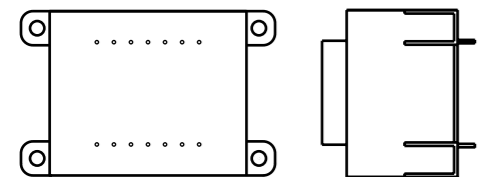

Typ „KK“
mit je zwei Befestigungen an der kurzen Seite

Type “KK”
two mounting brackets on each short side

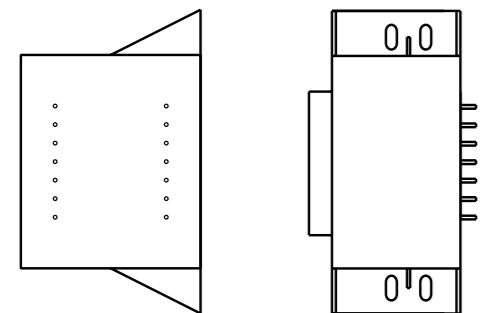

Typ „VL“
für vertikale Montage, magnetische Achse senkrecht

Type “VL”
for vertical mounting, vertical magnetic axis

So finden Sie uns

How to reach us



Unsere Koordinaten
Our coordinates
48° 09' 01.60" N 8° 47' 11.08" O



MARSCHNER TECH POWER ELECTRONICS GmbH & Co KG
Siemensstraße 11
78564 Wehingen
Germany
Phone: +49 (0)7426 609-0
Fax: +49 (0)7426 609-10
info_marschner@tpe.group

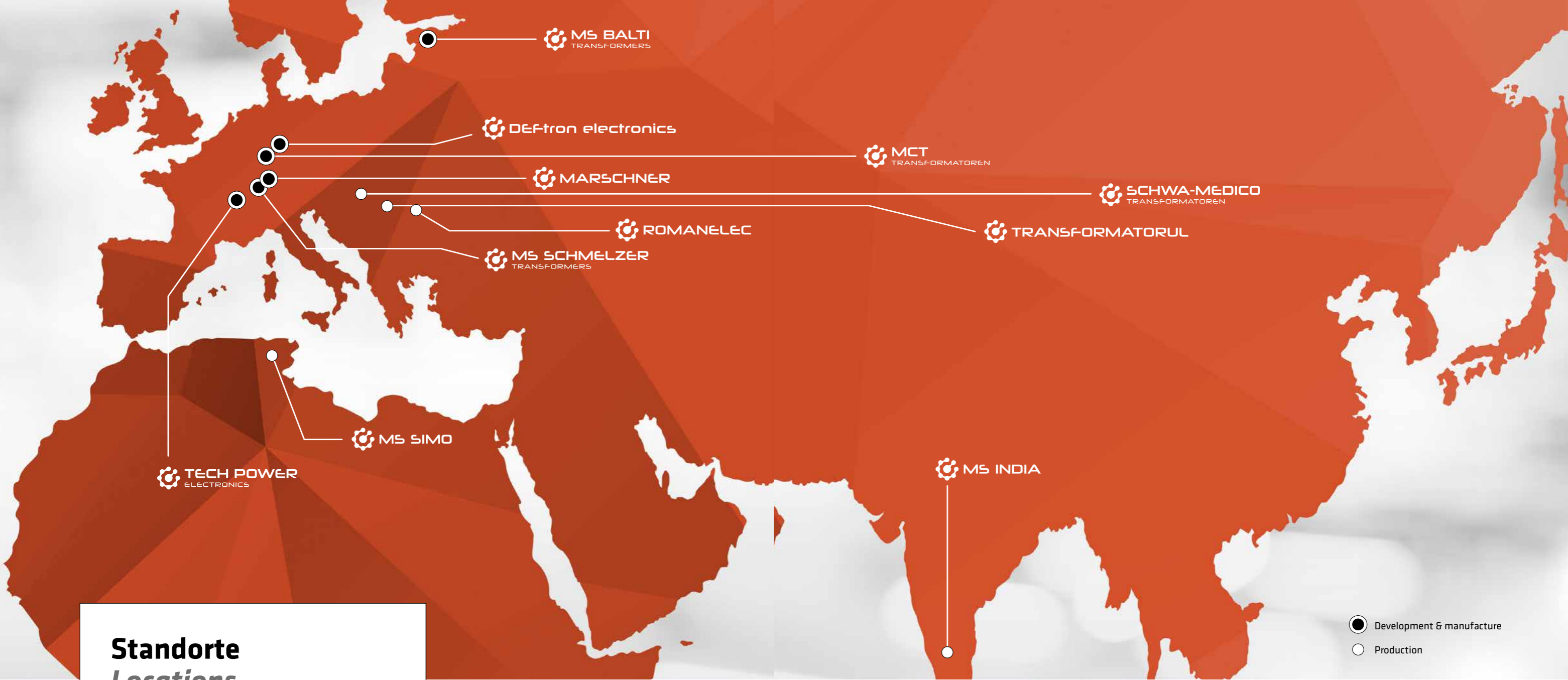

Standorte Locations

● **DEFTRON ELECTRONIC GmbH**
Philipp-Reis-Straße 5
35321 Laubach
Germany

Phone: +49 (0) 6405 50580-0
Fax: +49 (0) 6405 3763
info@tpe.group

● **MANFRED SCHMELZER GmbH**
Waidplatzstraße 6 - 8
79331 Teningen-Nimbur
Germany

Phone: +49 (0) 7663 9447 - 0
Fax: +49 (0) 7663 9447 - 50
info@tpe.group

● **MS BALTI Trafo OÜ**
Vihtra tee 3a
87701 Vändra
Estonia

Phone: +37 (0) 2447 166 - 0
Fax: +37 (0) 2447 166 - 7
info@msbaltitrafo.ee

● **TECH POWER ELECTRONICS**
ZI Les Plaines
39570 Courlaoux
France

Phone: +33 (0) 3842 52626
Fax: +33 (0) 3842 52610
sales@techpowerelectronics.com

● **MCT TRANSFORMATOREN GmbH**
Oberurseler Straße 61 - 63
61440 Oberursel
Germany

Phone: +49 (0) 6171 501 - 0
Fax: +49 (0) 6171 501 - 311
mct@tpe.group

● **MARSCHNER GmbH**
Siemensstrasse 11
78564 Wehingen
Germany

Phone +49 (0) 7426 609-0
Fax +49 (0) 7426 609-10
sales@marschner.com

○ **SCHWA-MEDICO KFT.**
Ajka, Téglagyári u. 21
8400 Hungary

Phone: +36 (0) 8850 0410

○ **MS INDIA**
M.S Transformers India Pvt Ltd.
1/512, Avinashi Main Road
Neelambur PostSulur Tk
Coimbatore - 641 062
Tamil Nadu
India

Phone: +91 (0) 97509-28810

○ **MS SIMO**
SIMO Tunisie S.A.R.L. Zone Industrielle
El Alia
7016 E Alia Bizerte
Tunisia

○ **ROMANELEC**
Str. Aurel Vlaicu 37 - 39
551041 Medias
Romania

Phone: +40 (0) 269 831877
Fax: +40 (0) 269 831738

○ **TRANSFORMATORUL**
Str. Faurilor Nr 140 - 142
310489 Arad, Romania

Phone: +40 (0) 257 272233

● Development & manufacture
○ Production



TECH POWER

ELECTRONICS GROUP



MARSCHNER TECH POWER
ELECTRONICS GmbH & Co KG
Siemensstraße 11
78564 Wehingen
Germany

Phone: +49 (0)7426 609-0
Fax: +49 (0)7426 609-10
info_marschner@tpe.group